

11074

VOLKSWAGEN RABBIT/GTI

9/28/2012

GROSS LOAD CAPACITY WHEN USED AS A WEIGHT CARRYING HITCH: 2,000 LBS. TRAILER WEIGHT & 200 LBS. TONGUE WEIGHT.

*****DO NOT EXCEED VEHICLE MANUFACTURER'S RECOMMENDED TOWING CAPACITY.*****

WARNING: ALL NON-TRAILER LOADS APPLIED TO THIS PRODUCT MUST BE SUPPORTED BY AUXILIARY STABILIZING STRAPS.

**** FAILURE TO PROPERLY SUPPORT NON-TRAILER LOADS WILL VOID PRODUCT WARRANTY****

HAVING INSTALLATION QUESTIONS? CALL TECHNICAL SUPPORT AT 1-800-798-0813

Parts List			
ITEM	QTY	PART NUMBER	DESCRIPTION
1	2	1/2 - 13 x 2"	CARRIAGE BOLT
2	2	HFN 1213	HEX FLANGE NUT
3	2	1_2 FISHWIRE	1/2" FISHWIRE
4	2	CM-SP10	.250 x 1.00 x 2.50" SQUARE HOLE SPACER

REVERSE PULL FISHWIRE TECHNIQUE

ATTACH FISHWIRE TO CARRIAGE BOLT AND SLIDE SPACER ONTO FISHWIRE. PUSH THE BOLT THRU THE HOLE FOLLOWED BY THE SPACER (AS SHOWN). PULL BOLT BACK INTO POSITION, PROTRUDING FROM THE FRAME.

WELDNUT CLEANING

To remove debris from weldnuts in frame, spray lubricant or compressed air into hole. For heavy debris, use a small wire brush. (Be careful not to damage threads.)

TOOLS REQUIRED

RACHET EXTENSION
3/4" SOCKET
18mm SOCKET
TORQUE WRENCH

HITCH WEIGHT: 28 LBS.
 INSTALL TIME
 PROFESSIONAL: 15 MINUTES
 NOVICE (DIY): 30 MINUTES
 INSTALL NOTES:
 -NO DRILLING REQUIRED
 -FISHWIRE HARDWARE

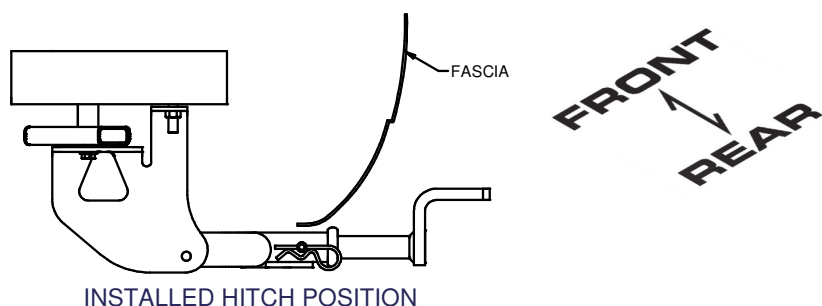
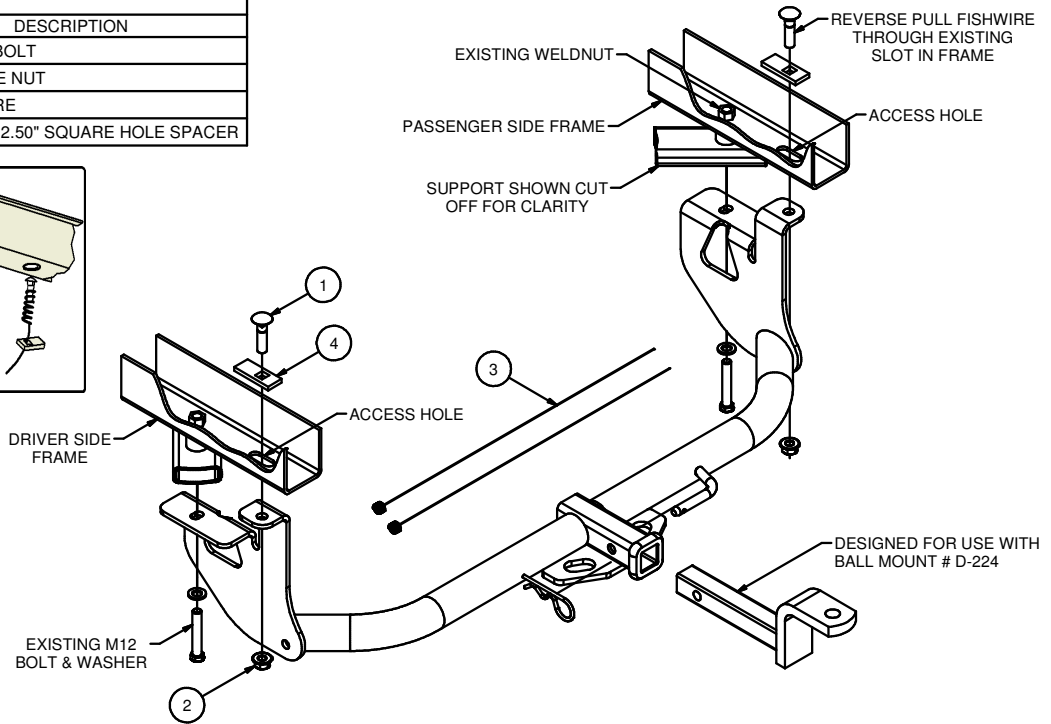

INSTALLATION STEPS

1. Reverse pull fishwire 1/2" carriage bolts and SP-10 spacers through access holes on driver and passenger side frames. (Leave fishwires attached)
2. Remove existing M12 bolts and washers from driver side and passenger side.
3. Raise hitch into position feeding fishwires through the hitch side plate holes. (Note: If necessary to get the passenger side into position, loosen the exhaust hanger on the passenger side to allow the exhaust bracket to move side to side.)
4. Re-install the M12 bolts and washers through hitch and frame support removed in Step 2.
5. Remove fishwires and install 1/2" flange nuts as shown.
6. Torque all 1/2" hardware to 110 ft-lbs and all M12 bolts to 79 ft-lbs.
7. Re-tighten the exhaust hanger on the passenger side if loosened in Step 3.

PERIODICALLY CHECK THIS RECEIVER HITCH TO ENSURE THAT ALL FASTENERS ARE TIGHT AND THAT ALL STRUCTURAL COMPONENTS ARE SOUND.

Curt Manufacturing Inc., warrants this product to be free of defects in material and/or workmanship at the time of retail purchase by the original purchaser. If the product is found to be defective, Curt Manufacturing Inc., may repair or replace the product, at their option, when the product is returned, prepaid, with proof of purchase. Alteration to, misuse of, or improper installation of this product voids the warranty. Curt Manufacturing Inc.'s liability is limited to repair or replacement of products found to be defective, and specifically excludes liability for incidental or consequential loss or damage.