

11130

2007-PRESENT Mini Cooper S Hardtop
2009-PRESENT Mini Cooper S Convertible

6/18/2020

Page 1 of 6

GROSS LOAD CAPACITY WHEN USED AS A WEIGHT CARRYING HITCH: 2,000 LBS. TRAILER WEIGHT & 200 LBS. TONGUE WEIGHT.

*****DO NOT EXCEED VEHICLE MANUFACTURER'S RECOMMENDED TOWING CAPACITY.*****

WARNING: ALL NON-TRAILER LOADS APPLIED TO THIS PRODUCT MUST BE SUPPORTED BY AUXILIARY STABILIZING STRAPS.

**** FAILURE TO PROPERLY SUPPORT NON-TRAILER LOADS WILL VOID PRODUCT WARRANTY****

HAVING INSTALLATION QUESTIONS? CALL TECHNICAL SUPPORT AT 1-877-287-8634

Parts List			
ITEM	QTY	PART NUMBER	DESCRIPTION
1	8	30-00148	WASHER,S-CON,3/8,YZ

TOOLS REQUIRED
OFFSET SCREWDRIVER
FLAT BLADE SCREWDRIVER
8mm SOCKET
13mm SOCKET
RATCHET
12" EXTENSION
TORQUE WRENCH

****CAUTION****

HITCH, BALL MOUNT, HITCH PIN AND HITCH PIN CLIP MAY BECOME HOT DURING VEHICLE OPERATION. USE CAUTION WHEN INSTALLING OR REMOVING ANY BALL MOUNTS OR ACCESSORIES.

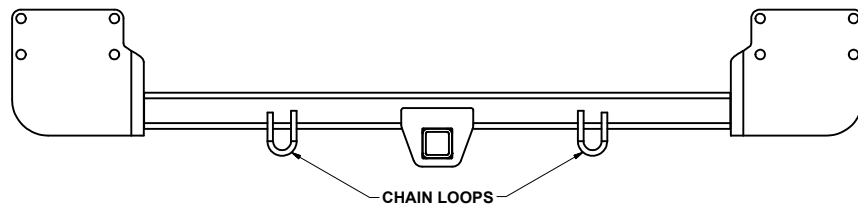
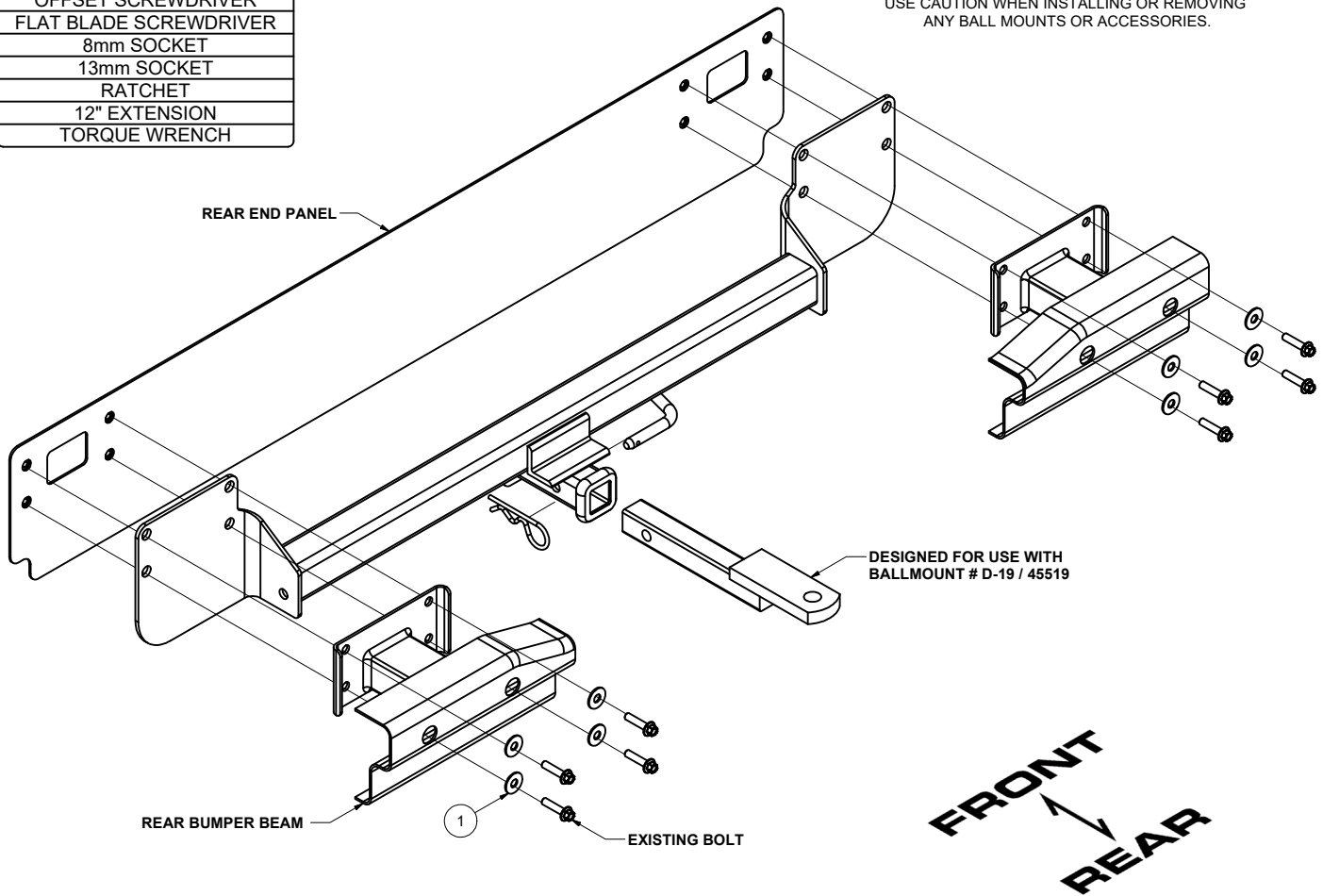

HITCH WEIGHT: 29 LBS.

INSTALL TIME

PROFESSIONAL: 60 MINUTES

NOVICE (DIY): 120 MINUTES

INSTALL NOTES:

- REMOVE BUMPER COVER
- MAY REQUIRE TRIMMING
- MAY REQUIRE HEAT SHIELD MODIFICATION

NOTE: Longer safety chains may be required to reach the chain loops. Verify that your safety chains are long enough to clear lower valance while turning before towing.

PERIODICALLY CHECK THIS RECEIVER HITCH TO ENSURE THAT ALL FASTENERS ARE TIGHT AND THAT ALL STRUCTURAL COMPONENTS ARE SOUND.

Curt Manufacturing Inc., warrants this product to be free of defects in material and/or workmanship at the time of retail purchase by the original purchaser. If the product is found to be defective, Curt Manufacturing Inc., may repair or replace the product, at their option, when the product is returned, prepaid, with proof of purchase. Alteration to, misuse of, or improper installation of this product voids the warranty. Curt Manufacturing Inc.'s liability is limited to repair or replacement of products found to be defective, and specifically excludes liability for incidental or consequential loss or damage.

GROSS LOAD CAPACITY WHEN USED AS A WEIGHT CARRYING HITCH: 2,000 LBS. TRAILER WEIGHT & 200 LBS. TONGUE WEIGHT.

*****DO NOT EXCEED VEHICLE MANUFACTURER'S RECOMMENDED TOWING CAPACITY.*****

WARNING: ALL NON-TRAILER LOADS APPLIED TO THIS PRODUCT MUST BE SUPPORTED BY AUXILIARY STABILIZING STRAPS.

**** FAILURE TO PROPERLY SUPPORT NON-TRAILER LOADS WILL VOID PRODUCT WARRANTY****

HAVING INSTALLATION QUESTIONS? CALL TECHNICAL SUPPORT AT 1-877-287-8634

INSTALLATION STEPS:

Removing the Bumper Cover:

1. Remove (11) fasteners that secure the bumper cover.

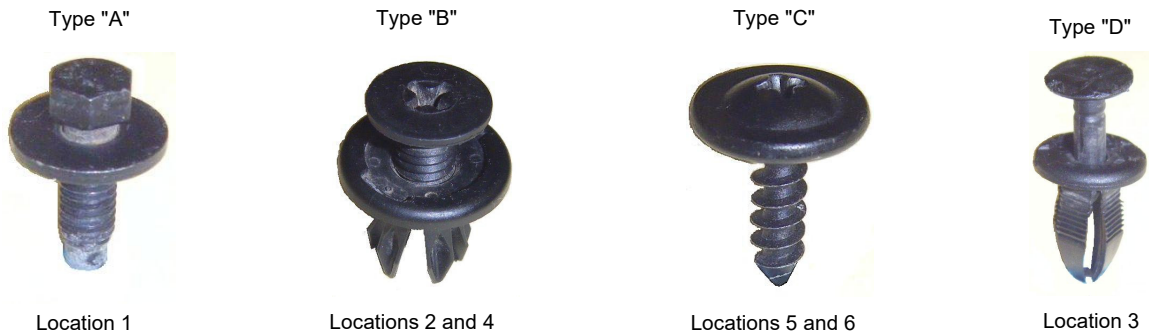

Photo 1: Fastener Types and Locations: "A" is a washer head hex screw, "B" are phillips head push fasteners, "C" are phillips head screws and "D" are push fasteners.



Photo 2: Fastener locations as viewed from inside of the bumper cover.
(These fastener locations are present on all models.)

2. Remove the washer head hex screw at the bottom of the bumper cover, near the muffler. (Location 1 in Photo 2)
3. Remove the (4) phillips head push fasteners, (2) at the back of each wheel opening. These are accessed from inside the fender well, behind the rear tire. (Locations 2 and 4 in Photo 2)

**PERIODICALLY CHECK THIS RECEIVER HITCH TO ENSURE THAT ALL FASTENERS
ARE TIGHT AND THAT ALL STRUCTURAL COMPONENTS ARE SOUND.**

Curt Manufacturing Inc., warrants this product to be free of defects in material and/or workmanship at the time of retail purchase by the original purchaser. If the product is found to be defective, Curt Manufacturing Inc., may repair or replace the product, at their option, when the product is returned, prepaid, with proof of purchase. Alteration to, misuse of, or improper installation of this product voids the warranty. Curt Manufacturing Inc.'s liability is limited to repair or replacement of products found to be defective, and specifically excludes liability for incidental or consequential loss or damage.

GROSS LOAD CAPACITY WHEN USED AS A WEIGHT CARRYING HITCH: 2,000 LBS. TRAILER WEIGHT & 200 LBS. TONGUE WEIGHT.

*****DO NOT EXCEED VEHICLE MANUFACTURER'S RECOMMENDED TOWING CAPACITY.*****

WARNING: ALL NON-TRAILER LOADS APPLIED TO THIS PRODUCT MUST BE SUPPORTED BY AUXILIARY STABILIZING STRAPS.

**** FAILURE TO PROPERLY SUPPORT NON-TRAILER LOADS WILL VOID PRODUCT WARRANTY****

HAVING INSTALLATION QUESTIONS? CALL TECHNICAL SUPPORT AT 1-877-287-8634

INSTALLATION STEPS:



Photo 3: Fastener B behind rear wheel well liner.

- Remove the (2) plastic push fasteners that hold the rear wheel arch to the rear bumper cover, one each side. They are behind the inner fender liner, at location 3 in Photos 2 and 3. To remove these fasteners, push down from the top until enough of the fastener is available from the bottom to pry it out. Remove both pieces.

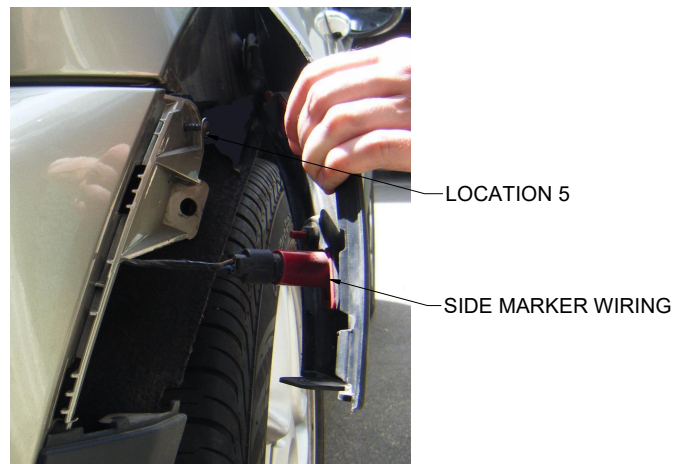

Photo 4: Fastener C behind wheel moulding.

- The next (2) screws are under the fender flair, as shown in Photo 4. To free the fender flair, push the bumper towards the front of the vehicle while pushing the fender flair towards the rear of the vehicle. To free the top clip, pry the arch away from the bumper.
- Remove the hidden screw at position 5. Disconnect the side marker light. Repeat for the other side.

**PERIODICALLY CHECK THIS RECEIVER HITCH TO ENSURE THAT ALL FASTENERS
ARE TIGHT AND THAT ALL STRUCTURAL COMPONENTS ARE SOUND.**

Curt Manufacturing Inc., warrants this product to be free of defects in material and/or workmanship at the time of retail purchase by the original purchaser. If the product is found to be defective, Curt Manufacturing Inc., may repair or replace the product, at their option, when the product is returned, prepaid, with proof of purchase. Alteration to, misuse of, or improper installation of this product voids the warranty. Curt Manufacturing Inc.'s liability is limited to repair or replacement of products found to be defective, and specifically excludes liability for incidental or consequential loss or damage.

GROSS LOAD CAPACITY WHEN USED AS A WEIGHT CARRYING HITCH: 2,000 LBS. TRAILER WEIGHT & 200 LBS. TONGUE WEIGHT.

*****DO NOT EXCEED VEHICLE MANUFACTURER'S RECOMMENDED TOWING CAPACITY.*****

WARNING: ALL NON-TRAILER LOADS APPLIED TO THIS PRODUCT MUST BE SUPPORTED BY AUXILIARY STABILIZING STRAPS.

**** FAILURE TO PROPERLY SUPPORT NON-TRAILER LOADS WILL VOID PRODUCT WARRANTY****

HAVING INSTALLATION QUESTIONS? CALL TECHNICAL SUPPORT AT 1-877-287-8634

INSTALLATION STEPS:

6. Remove the final two screws located at position 6 in Photo 2. These are the screws you see when you open your hatch.
If present, remove the rear light, disconnect the wiring harness from the back of the bumper cover and remove the light from the back side by depressing the tabs on both sides of the light.
7. Pull back and up on the center of the bumper cover to release it from the center mount. Photo 5 shows the tab you are releasing behind the bumper cover.
8. Support the bumper cover. If you have backup sensors disconnect the wiring harness at this time. (Your bumper cover should be free from the car.)



Photo 5: Tab located at center of hatch under the bumper cover.



Photo 6: Bumper beam cross member removed (if equipped on vehicle.)

Hitch Installation:

Note: The hitch mounts between the vehicle's rear body panel and the factory bumper beam using the original bumper beam mounting bolts as shown in Photos 8 & 9.

1. Disconnect the wiring harness from the bumper beam by removing the (2) push fasteners on the top of the bumper beam.
2. Remove the bumper beam by removing the (8) M8 bolts holding the bumper beam to the vehicle. (See Photo 7) (Save the bolts and bumper beam for use in Step 3.)

Note: If vehicle is equipped with bumper beam cross member, please remove and return to the vehicle's owner. Hitch will replace cross member during hitch installation. (See Photo 6)

3. Lift the hitch and bumper beam into position and secure them using the (8) M8 bolts (removed in Step 2) and the supplied conical toothed washers, as shown in Photos 8 and 9. **Note:** Trim foam behind bumper beam as needed for proper fit.
4. Torque all M8 hardware to 23 ft-lbs.
5. Reconnect the wiring harness to the bumper beam by reinstalling the push fasteners remove in Step 1.

PERIODICALLY CHECK THIS RECEIVER HITCH TO ENSURE THAT ALL FASTENERS ARE TIGHT AND THAT ALL STRUCTURAL COMPONENTS ARE SOUND.

GROSS LOAD CAPACITY WHEN USED AS A WEIGHT CARRYING HITCH: 2,000 LBS. TRAILER WEIGHT & 200 LBS. TONGUE WEIGHT.

*****DO NOT EXCEED VEHICLE MANUFACTURER'S RECOMMENDED TOWING CAPACITY.*****

WARNING: ALL NON-TRAILER LOADS APPLIED TO THIS PRODUCT MUST BE SUPPORTED BY AUXILIARY STABILIZING STRAPS.

**** FAILURE TO PROPERLY SUPPORT NON-TRAILER LOADS WILL VOID PRODUCT WARRANTY****

HAVING INSTALLATION QUESTIONS? CALL TECHNICAL SUPPORT AT 1-877-287-8634

INSTALLATION STEPS:



Photo 7: Bumper beam removed.



Photo 8: Hitch in position.

Notes:

- On Mini Coopers with center exhaust the heat shield must be formed around the hitch to allow clearance. This can be done by simply pulling up on the end of the heat shield creating a divot. (See Photo 10)
- On the 2007+ Mini Cooper S, the rear valance will need to be modified, see trim detail. **Note: check fit prior to trimming.** Remove the rear valance by releasing the tabs holding it to the bumper cover using a flat blade screwdriver. After trimming reinstall the rear valance by reinserting into the bumper cover and popping the tabs back into place.

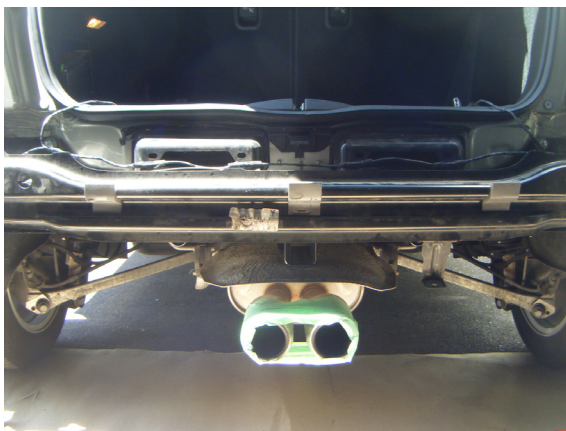
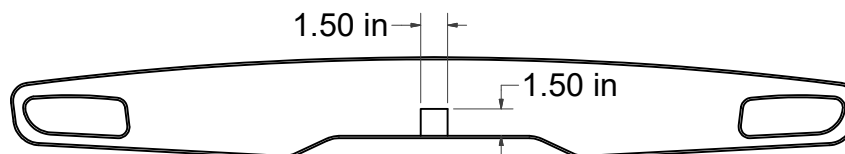

Photo 9: Hitch and bumper beam installed



Photo 10: Mini Cooper S



REAR VALANCE TRIM DETAIL

PERIODICALLY CHECK THIS RECEIVER HITCH TO ENSURE THAT ALL FASTENERS ARE TIGHT AND THAT ALL STRUCTURAL COMPONENTS ARE SOUND.

Curt Manufacturing Inc., warrants this product to be free of defects in material and/or workmanship at the time of retail purchase by the original purchaser. If the product is found to be defective, Curt Manufacturing Inc., may repair or replace the product, at their option, when the product is returned, prepaid, with proof of purchase. Alteration to, misuse of, or improper installation of this product voids the warranty. Curt Manufacturing Inc.'s liability is limited to repair or replacement of products found to be defective, and specifically excludes liability for incidental or consequential loss or damage.

GROSS LOAD CAPACITY WHEN USED AS A WEIGHT CARRYING HITCH: 2,000 LBS. TRAILER WEIGHT & 200 LBS. TONGUE WEIGHT.

*****DO NOT EXCEED VEHICLE MANUFACTURER'S RECOMMENDED TOWING CAPACITY.*****

WARNING: ALL NON-TRAILER LOADS APPLIED TO THIS PRODUCT MUST BE SUPPORTED BY AUXILIARY STABILIZING STRAPS.

**** FAILURE TO PROPERLY SUPPORT NON-TRAILER LOADS WILL VOID PRODUCT WARRANTY****

HAVING INSTALLATION QUESTIONS? CALL TECHNICAL SUPPORT AT 1-877-287-8634

INSTALLATION STEPS:

Reinstalling the Bumper Cover:

Notes:

- Refer to photos 1 - 4 while reinstalling the bumper cover.
- When installing the bumper cover on the vehicle, you will use (3) height locators. (See Photos 11 and 12)
The bumper hangs from the center alignment feature and side alignment features.
- 1. If removed, reattach the wiring harness for the back up sensors.
- 2. Loosley install the (2) screws inside the hatch opening to allow room for adjustment.
- 3. Tighten the (2) fasteners inside the rear body flairs. Next re-attach the fender flare to the rear bumper and reinstall fasteners behind the wheel well liner.
- 4. Secure the inner fender well liner to the body using the (4) phillips head push fasteners.
- 5. Tighten the two phillips head screws inside the hatch opening.
- 6. Tighten the washer head hex screw in the bottom of the bumper cover.

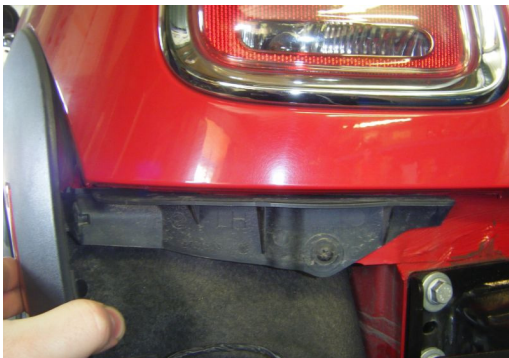

Photo 11: Side alignment feature.



Photo 12: Center alignment feature.



Photo 13: Hitch shown installed with safety chains

**PERIODICALLY CHECK THIS RECEIVER HITCH TO ENSURE THAT ALL FASTENERS
ARE TIGHT AND THAT ALL STRUCTURAL COMPONENTS ARE SOUND.**

Curt Manufacturing Inc., warrants this product to be free of defects in material and/or workmanship at the time of retail purchase by the original purchaser. If the product is found to be defective, Curt Manufacturing Inc., may repair or replace the product, at their option, when the product is returned, prepaid, with proof of purchase. Alteration to, misuse of, or improper installation of this product voids the warranty. Curt Manufacturing Inc.'s liability is limited to repair or replacement of products found to be defective, and specifically excludes liability for incidental or consequential loss or damage.