

YEARS: 2011-PRESENT

MAKE: CADILLAC

MODEL: CTS (EXCLUDING CTS-V)

STYLE: COUPE

WARNING: NEVER EXCEED YOUR VEHICLE MANUFACTURER'S RECOMMENDED TOWING CAPACITY



WEIGHT CARRYING:
 TRAILER WEIGHT: 2,000 LBS.
 TONGUE WEIGHT: 200 LBS.

WARNING:
 WE RECOMMEND THE USE OF 18050 STABILIZING STRAPS FOR ALL NON-TRAILER (WHEEL-LESS) LOADS. PLEASE SEE THE CURT CATALOG OR VISIT US ONLINE AT WWW.CURTMFG.COM FOR FURTHER INFORMATION.

INSTALLATION TIME: 40 MIN.

THE INSTALL TIME LISTED IS FOR PROFESSIONAL INSTALLERS. IF YOU ARE HESITANT TO UNDERTAKE THIS TASK ON YOUR OWN, CONTACT AN AUTHORIZED CURT INSTALLER FOR ADDITIONAL ASSISTANCE.



INSTALLATION REQUIRES:

 PRY BAR	 RATCHET	 13mm 3/4" SOCKET
 BOXED END WRENCH 13mm	 TORQUE WRENCH	 SAFETY GLASSES

INSTALLATION TIPS:

- BEFORE YOU BEGIN INSTALLATION, READ ALL INSTRUCTIONS THOROUGHLY.
- TO EASE INSTALLATION, 2 PEOPLE MAY BE REQUIRED.
- USING PROPER TOOLS WILL GREATLY IMPROVE THE QUALITY OF THE INSTALL AND REDUCE THE TIME REQUIRED.
- NEED HELP OR HAVE SOME QUESTIONS? CALL TECHNICAL SUPPORT AT 800.798.0813

LEVEL OF DIFFICULTY: MODERATE

EASY	MODERATE	CHALLENGING
	LOWER EXHAUST	
	NO DRILLING REQUIRED	

VEHICLE PHOTO:



HITCH ILLUSTRATION:

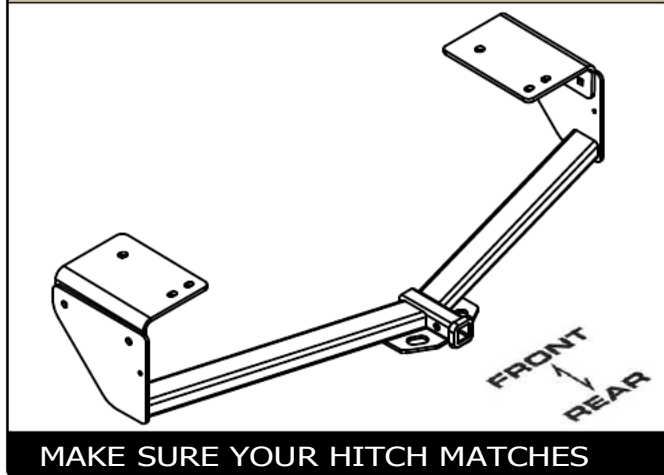

PERIODICALLY CHECK THIS RECEIVER HITCH TO ENSURE ALL FASTENERS ARE TIGHT AND ALL STRUCTURAL COMPONENTS ARE SOUND

CURT Manufacturing LLC. warrants this product to be free of defects in material and/or workmanship at the time of retail purchase by the original purchaser. If the product is found to be defective, Curt Manufacturing LLC. may repair or replace the product at their option, when the product is returned, prepaid, with proof of purchase. Alteration to, misuse of, or improper installation of this product voids the warranty. Curt Manufacturing LLC.'s liability is limited to repair or replacement of products found to be defective, and specifically excludes liability for incidental or consequential loss or damage.

INSTALLATION WALKTHROUGH:

Parts List			
ITEM	QTY	PART NUMBER	DESCRIPTION
1	6	1/2-13 x 1 1/4	CARRIAGE BOLT
2	2	CM-SP6	.250 x 1.00 x 3.00" SQUARE HOLE SPACER
3	6	HFN 1213	HEX FLANGE NUT
4	2	1_2 FISHWIRE	1/2" FISHWIRE

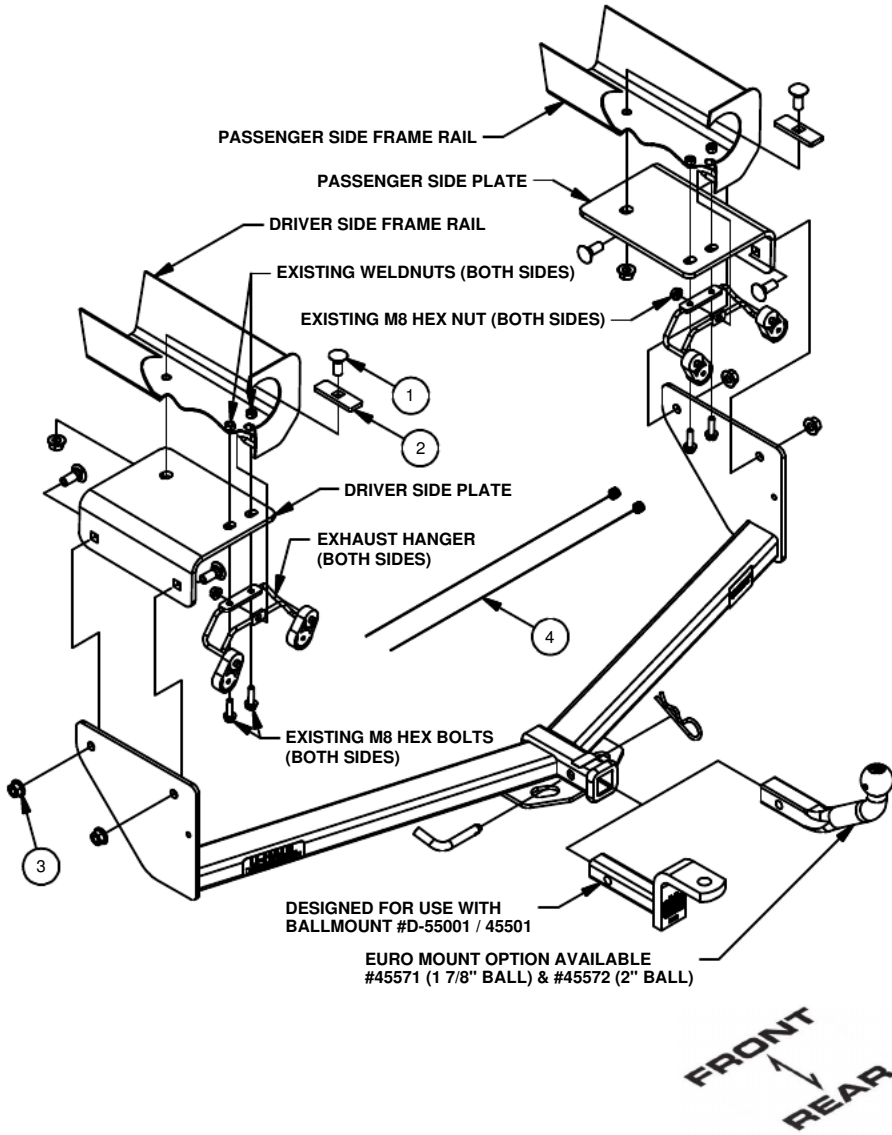

1. Remove (2) exhaust hangers by unbolting (4) M8 hex bolts and (2) M8 hex nuts.



2. Lower exhaust by removing (2) forward rubber isolators.

RUBBER ISOLATOR REMOVAL DIAGRAM

This technique can be used if an Exhaust Hanger Removal Pliers is not available.

Using a 5/8" open end wrench, slide the wrench up to the rubber isolator, cradling the hanger rod as shown. Next place the flat edge of a pry bar between the wrench and the hanger stop or hanger rod. Then simply rotate the pry bar toward the wrench to remove the rubber isolator.

Note: Using a spray lubricant or soapy water on the hanger rod and the rubber isolator helps removal.

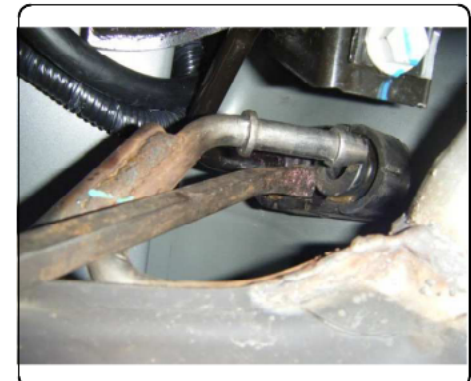

INSTALLATION WALKTHROUGH:

3. Fishwire (1) 1/2" carriage bolt and (1) CM-SP6 spacer into forward most hole in each frame rail, as shown.

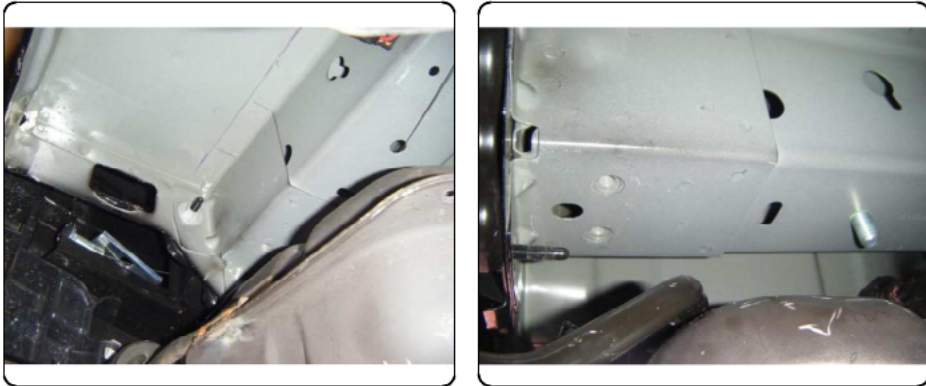

4. Raise driver side plate into position on driver side frame rail and loosely fasten with 1/2" flange nut.

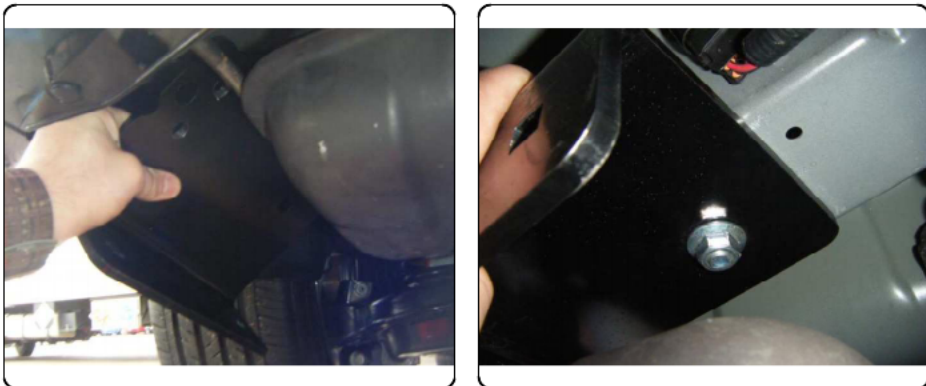

5. Place exhaust hanger back into position. (Plate will now be sandwiched between frame rail and exhaust hanger.) Reinstall (1) M8 hex nut which was removed in STEP 1.
Note: Tighten this nut and slide plate forward or back until holes are aligned with weldnuts.



6. Reinstall (2) M8 hex bolts which were removed in STEP 1. Repeat STEPS 4-6 with passenger side plate.

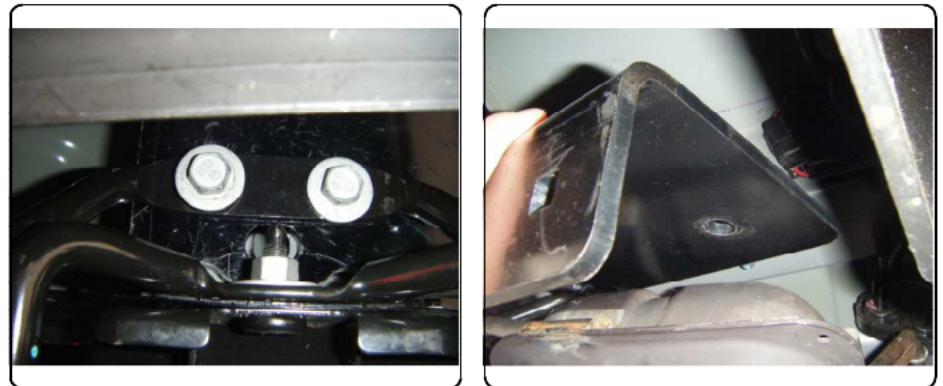

INSTALLATION WALKTHROUGH:

7. Temporarily raise hitch into position and adjust plates as needed for hitch to slide over outsides of plates.

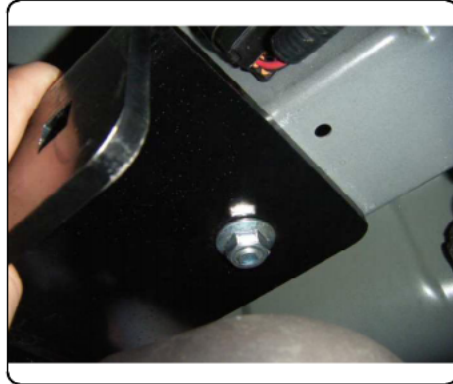

8. Lower hitch and torque all 1/2" hardware to 110 ft-lbs and all M8 hardware to 23 ft-lbs.



9. Raise hitch into position and fasten to side plates with 1/2" hardware, as shown above. Torque all 1/2" hardware to 75 ft-lbs. Reinstall (2) rubber isolators which were removed in STEP 1.



Install is complete.

Caution: Ballmount may become hot due to center exhaust!!!

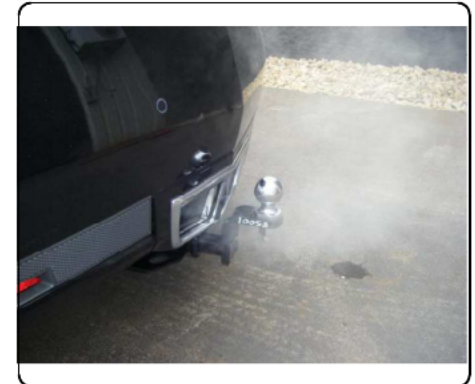

11196

CADILLAC CTS COUPE (EXCLUDING CTS-V)

12/7/2012

GROSS LOAD CAPACITY WHEN USED AS A WEIGHT CARRYING HITCH: 2,000 LBS. TRAILER WEIGHT & 200 LBS. TONGUE WEIGHT.

*****DO NOT EXCEED VEHICLE MANUFACTURER'S RECOMMENDED TOWING CAPACITY.*****

WARNING: ALL NON-TRAILER LOADS APPLIED TO THIS PRODUCT MUST BE SUPPORTED BY 18050 STABILIZING STRAPS.

**** FAILURE TO PROPERLY SUPPORT NON-TRAILER LOADS WILL VOID PRODUCT WARRANTY****

HAVING INSTALLATION QUESTIONS? CALL TECHNICAL SUPPORT AT 1-877-287-8634

Parts List			
ITEM	QTY	PART NUMBER	DESCRIPTION
1	6	1/2-13 x 1 1/4	CARRIAGE BOLT
2	2	CM-SP6	.250 x 1.00 x 3.00" SQUARE HOLE SPACER
3	6	HFN 1213	HEX FLANGE NUT
4	2	1_2 FISHWIRE	1/2" FISHWIRE

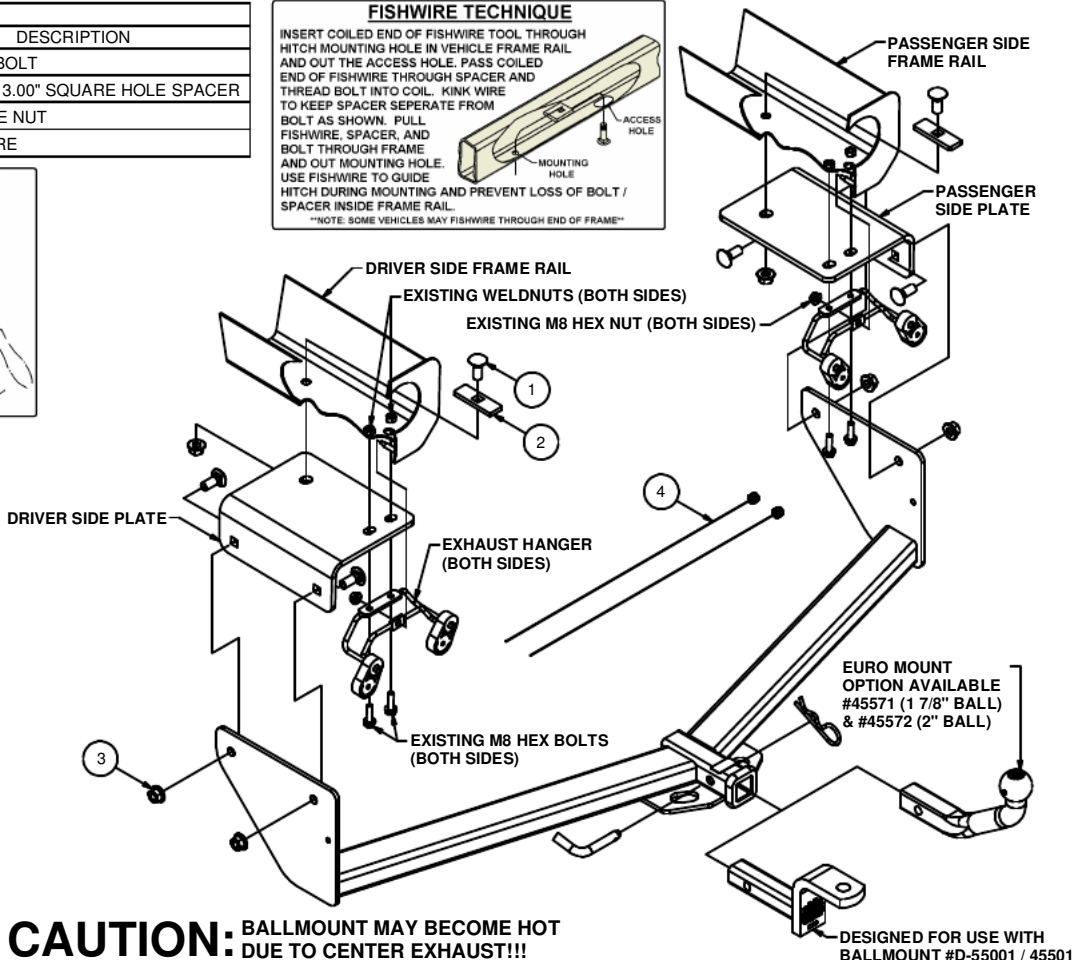
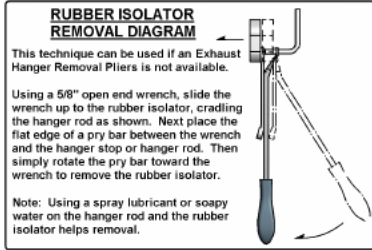
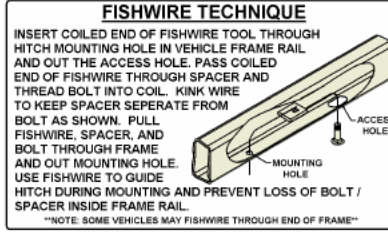

FRONT
↑
REAR

TOOLS REQUIRED

PRY BAR
RATCHET
13mm, 3/4" SOCKETS
13mm BOXED END WRENCH
TORQUE WRENCH

HITCH WEIGHT: 52 LBS.

INSTALL TIME

PROFESSIONAL: 40 MINUTES

NOVICE (DIY): 80 MINUTES

INSTALL NOTES:

- LOWER EXHAUST
- NO DRILLING REQUIRED

CAUTION: BALLMOUNT MAY BECOME HOT DUE TO CENTER EXHAUST!!!

DESIGNED FOR USE WITH BALLMOUNT #D-55001 / 45501

INSTALLATION STEPS

1. Remove (2) exhaust hangers by unbolting (4) M8 hex bolts and (2) M8 hex nuts. Lower exhaust by removing (2) forward rubber isolators. See RUBBER ISOLATOR REMOVAL DIAGRAM above.
2. Fishwire (1) 1/2" carriage bolt and (1) CM-SP6 spacer into forward most hole in each frame rail, as shown above. See FISHWIRE TECHNIQUE above.
3. Raise driver side plate into position on driver side frame rail and loosely fasten with 1/2" flange nut.
4. Place exhaust hanger back into position. (Plate will now be sandwiched between frame rail and exhaust hanger.) Reinstall (1) M8 hex nut which was removed in STEP 1. **Note:** Tighten this nut and slide plate forward or back until holes are aligned with weldnuts.
5. Reinstall (2) M8 hex bolts which were removed in STEP 1. Repeat STEPS 3-5 with passenger side plate.
6. Temporarily raise hitch into position and adjust plates as needed for hitch to slide over outsides of plates.
7. Lower hitch and torque all 1/2" hardware to 110 ft-lbs and all M8 hardware to 23 ft-lbs.
8. Raise hitch into position and fasten to side plates with 1/2" hardware, as shown above. Torque all 1/2" hardware to 110 ft-lbs. Reinstall (2) rubber isolators which were removed in STEP 1.

PERIODICALLY CHECK THIS RECEIVER HITCH TO ENSURE THAT ALL FASTENERS ARE TIGHT AND THAT ALL STRUCTURAL COMPONENTS ARE SOUND.

Curt Manufacturing LLC., warrants this product to be free of defects in material and/or workmanship at the time of retail purchase by the original purchaser. If the product is found to be defective, Curt Manufacturing LLC., may repair or replace the product, at their option, when the product is returned, prepaid, with proof of purchase. Alteration to, misuse of, or improper installation of this product voids the warranty. Curt Manufacturing LLC.'s liability is limited to repair or replacement of products found to be defective, and specifically excludes liability for incidental or consequential loss or damage.