

YEARS: 2013-PRESENT

MAKE: CADILLAC

MODEL: ATS

STYLE: SEDAN & COUPE

**WARNING: NEVER EXCEED YOUR VEHICLE MANUFACTURER'S RECOMMENDED TOWING CAPACITY**  
 For more information log onto [www.curtmfg.com](http://www.curtmfg.com) & for helpful towing tips log onto [www.hitchinfo.com](http://www.hitchinfo.com)

**WEIGHT CARRYING:**  
 TRAILER WEIGHT: 2,000 LBS.  
 TONGUE WEIGHT: 200 LBS.

**WARNING:**  
 WE RECOMMEND THE USE OF 18050 STABILIZING STRAPS FOR ALL NON-TRAILER (WHEEL-LESS) LOADS. PLEASE SEE THE CURT CATALOG OR VISIT US ONLINE AT [WWW.CURTMFG.COM](http://WWW.CURTMFG.COM) FOR FURTHER INFORMATION.

**PRO INSTALL TIME: 30 MIN.**  
**NOVICE INSTALL TIME: 60 MIN.**

IF YOU ARE HESITANT TO UNDERTAKE THIS TASK ON YOUR OWN, CONTACT AN AUTHORIZED CURT INSTALLER FOR ADDITIONAL ASSISTANCE.

**INSTALLATION REQUIRES:**

<b>SAFETY GLASSES</b>	<b>T-15 TORXBIT SOCKET</b>	<b>RATCHET</b>
<b>7mm 10mm 13mm 15mm SOCKET</b>	<b>3/4" SOCKET</b>	<b>PRY BAR</b>
<b>SPRAY LUBRICANT</b>	<b>CUT-OFF WHEEL</b>	<b>TAPE MEASURE</b>
<b>MARKER</b>	<b>AVIATION SHEARS</b>	<b>TORQUE WRENCH</b>

**INSTALLATION TIPS:**

- BEFORE YOU BEGIN INSTALLATION, READ ALL INSTRUCTIONS THOROUGHLY.
- TO EASE INSTALLATION, 2 PEOPLE MAY BE REQUIRED.
- USING PROPER TOOLS WILL GREATLY IMPROVE THE QUALITY OF THE INSTALL AND REDUCE THE TIME REQUIRED.
- NEED HELP OR HAVE SOME QUESTIONS? CALL TECHNICAL SUPPORT AT 800.798.0813

**LEVEL OF DIFFICULTY: MODERATE**

EASY	MODERATE	CHALLENGING
	LOWER EXHAUST TO EASE INSTALLATION	
	FISHWIRING REQUIRED	
	REMOVAL OF EXHAUST SUPPORT STRAP MAY EASE INSTALLATION	
	PLASTIC AND HEAT SHIELD TRIMMING REQUIRED	
	NO DRILLING REQUIRED	

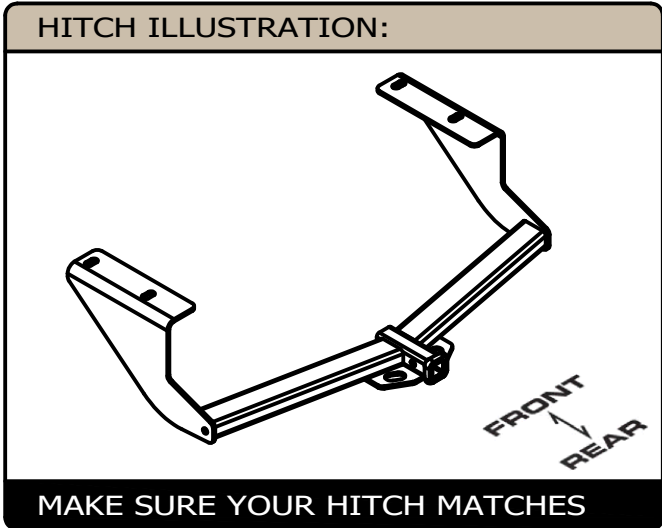

**PERIODICALLY CHECK THIS RECEIVER HITCH TO ENSURE ALL FASTENERS ARE TIGHT AND ALL STRUCTURAL COMPONENTS ARE SOUND**

CURT Manufacturing LLC. warrants this product to be free of defects in material and/or workmanship at the time of retail purchase by the original purchaser. If the product is found to be defective, CURT Manufacturing LLC. may repair or replace the product at their option, when the product is returned, prepaid, with proof of purchase. Alteration to, misuse of, or improper installation of this product voids the warranty. CURT Manufacturing LLC.'s liability is limited to repair or replacement of products found to be defective, and specifically excludes liability for incidental or consequential loss or damage.

For more information log onto [www.curtmfg.com](http://www.curtmfg.com), & for helpful towing tips log onto [www.hitchinfo.com](http://www.hitchinfo.com)

This product complies with safety specifications and requirements for connecting devices and towing systems of the state of New York, V.E.S.C.Regulation V-5 and SAE J684.

SCAN FOR MORE INFO

## INSTALLATION WALKTHROUGH:

Parts List			
ITEM	QTY	PART NUMBER	DESCRIPTION
1	4	1/2-13 x 1 1/2	CARRIAGE BOLT
2	4	HFN 1213	HEX FLANGE NUT
3	4	CM-SP6	.250 x 1.00 x 3.00" SQUARE HOLE SPACER
4	4	1_2 x 30 FISHWIRE	1/2" x 30" FISHWIRE

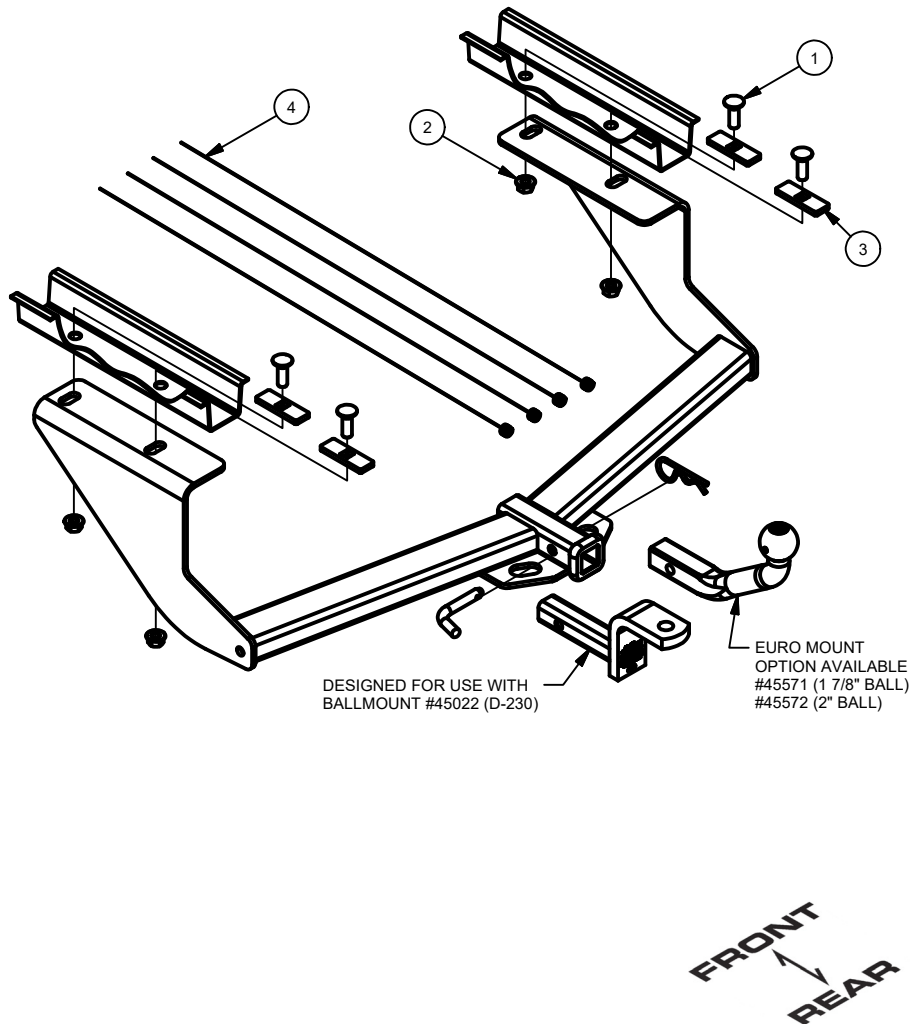

1. Remove (14) screws that secure plastic fascia to bottom of vehicle. This will allow fascia to be pulled away from exhaust, and allow heat shield to be removed. Coupe models: Remove fasteners with a 7mm socket.



2. Lower exhaust by first removing (2) bolts on each side from the end of the vehicle frame rails that secure the exhaust hanger brackets. Remove brackets from hanger pegs on muffler. Then remove the rubber exhaust hangers, (4) places forward of mufflers (3) places on Coupe models.

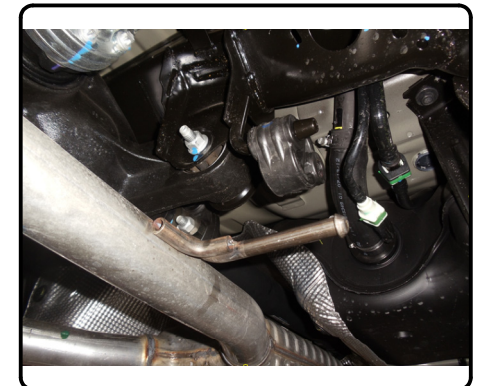
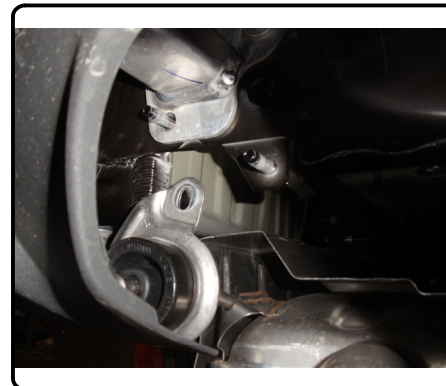



## INSTALLATION WALKTHROUGH:

3. It may be necessary to remove support strap to allow exhaust to hang lower and allow heat shield to be fully removed. It will be necessary to gently pull fascia downward to allow muffler pegs to be below fascia.



4. Remove heat shield by removing (8) nuts which secure it to the vehicle. Retain (6) nuts for reinstallation after heat shield trimming.

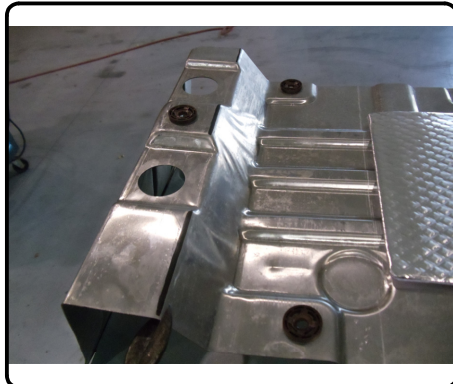

5. Cut off stud from each frame rail that secured the heat shield.

6. Mark heat shield as shown and trim to allow access to both frame rails. Reattach trimmed heat shield using (6) nuts removed in Step 4.

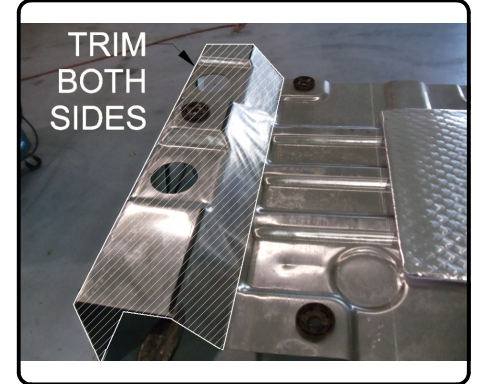
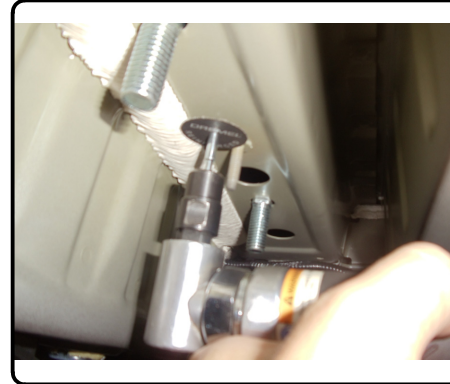

7. Trim vehicle fascia as shown on each side of the vehicle to allow for hitch side plate reinstallation, approximately 1-3/8" each side.

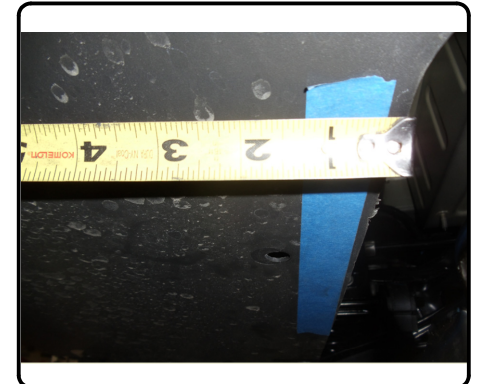

## INSTALLATION WALKTHROUGH:

8. Fishwire 1/2" carriage bolts and spacer blocks up through slots in vehicle frame and down through attaching holes in hitch side plates, 2 places, each side.



9. Raise hitch and exhaust into position simultaneously, being careful not to push bolts back into frame. Secure with 1/2" flange hex nuts. Torque all 1/2" hardware to 110 lb-ft. Follow Step 1 in reverse order to raise hitch back into position. Reattach exhaust support strap if removed in Step 3.

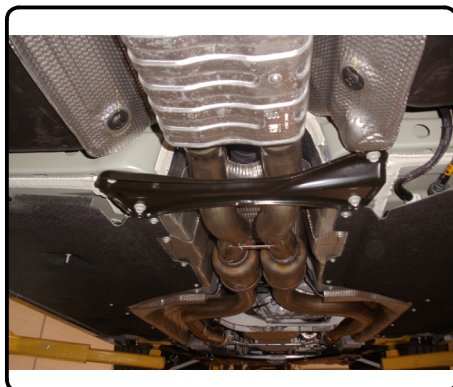
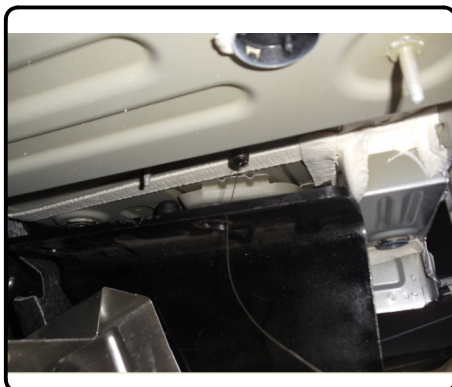

10. Install complete.





## TOWING SAFETY INFORMATION

### Gross Trailer Weight / GTW

The Gross Trailer Weight is the weight of the trailer & cargo. Measure this by putting the fully loaded trailer on a vehicle scale.

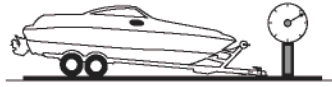

### Tongue Weight / TW

The downward force that is exerted on the hitch ball by the coupler. The tongue weight will vary depending on where the load is positioned in relationship to the trailer axle(s). To measure the tongue weight, use either a commercial scale or a bathroom scale with the coupler at towing height. When using a bathroom scale with heavier tongue weights, use the method shown and multiply the scale reading by 3.

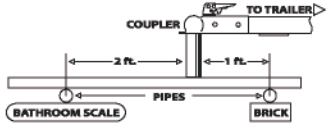

### Weight Carrying / WC

The total weight of both the trailer and the cargo inside. Never exceed the weight capacity of your trailer hitch.

### Weight Distribution / WD

Used to balance the weight of the cargo between the front and rear wheels throughout the trailer, allowing for better steering, braking, and level riding.



### Sway Control

A device used to reduce the lateral movements of the trailer that are caused by the wind. This works in conjunction with a weight distribution hitch. Do not use this on a class 1 or 2 hitch, or with surge brakes.

### How Much Can You Safely Tow?

TONGUE WEIGHT lbs	1000	2000	3000	4000	5000	6000	7000	8000	10,000	12,000
Tongue weight should be about 10 to 15 percent of the gross trailer weight.										
CLASS 1										
CLASS 2										
CLASS 3										
CLASS 4										
CLASS 5										
<b>Camper</b>	11'	12'	13'	14'	15'	16'				
lbs	1100	1200	1300	1400	1500	1600				
<b>Vacation</b>	14'	16'	18'	20'	22'	24'	26'	28'	30'	32'
lbs	2100	2400	2700	3000	3300	3600	3900	4200	4500	4800
<b>Vacation</b>	14'	16'	18'	20'	22'	24'	26'	28'	30'	32'
lbs	2800	3200	3600	4000	4400	4800	5200	5600	6000	6400
<b>5th Wheel</b>										

Refer to owner's manual for towing capabilities and limitations.

### Ball Mount

The ball mount is placed inside the opening of the receiver hitch which is mounted to the vehicle. Make sure a hitch pin and clip is properly securing the ball mount to the receiver hitch before you begin towing.

- A: Rise. B: Drop. C: Hole Size. D: Length.

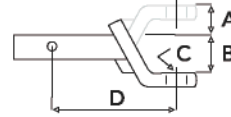

### Trailer Ball

The connection from the hitch to the trailer. There are many factors that determine the correct hitch ball:

- Number one is the hitch ball's gross trailer weight rating.
- The mounting platform must be at least 3/8" thick.
- The hole diameter must not be more than 1/16" larger than the threaded shank.
- Every time you tow, check the nut and lock washer to make sure they are fastened securely.
- A: Ball Dia. B: Shank Dia. C: Shank Length. D: Shank Rise.

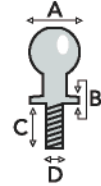

### Coupler

The component that is placed over the trailer ball to connect the vehicle to the trailer. Be sure that the coupler size matches the size of the hitch ball and that the coupler handle is securely fastened. To determine what size hitch ball you need for your application you will need to know the size of coupler that is on the trailer. Be sure your coupler is properly adjusted to the ball you are using.

NOTE: For added security the use of safety devices such as Coupler Safety Pins and Locks is strongly recommended.

### Safety Chains

Safety chains are a requirement and should be crossed under the tongue of the trailer so that the tongue will not drop to the road if it becomes separated from the hitch. Always leave enough slack so you can turn. Never allow the safety chains to drag on the ground and never attach the chains to the bumper.

Trailer Classification: Safety Chain Breaking Force - Minimum

Class 1: 2,000 lbs. (8.9 kN)

Class 2: 3,500 lbs. (15.6 kN)

Class 3: 5,000 lbs. (22.2 kN)

The strength rating of each length of safety chain or its equivalent and its attachments shall be equal to or exceed in minimum breaking force the GVWR (Gross Vehicle Weight Rating) of the trailer.

### Electrical

Trailer lights, Electric Brakes, Break-away systems - Every time you tow, be sure to check that all components are working properly.

Wiring identification by color:

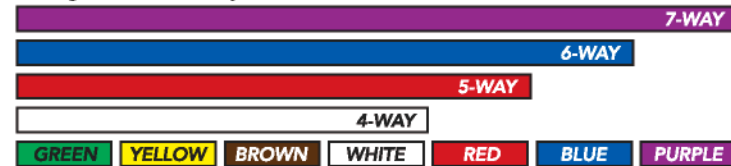

GROSS LOAD CAPACITY WHEN USED AS A WEIGHT CARRYING HITCH: 2,000 LBS. TRAILER WEIGHT & 200 LBS. TONGUE WEIGHT.

\*\*\*DO NOT EXCEED VEHICLE MANUFACTURER'S RECOMMENDED TOWING CAPACITY.\*\*\*

WARNING: ALL NON-TRAILER LOADS APPLIED TO THIS PRODUCT MUST BE SUPPORTED BY 18050 STABILIZING STRAPS.

\*\* FAILURE TO PROPERLY SUPPORT NON-TRAILER LOADS WILL VOID PRODUCT WARRANTY\*\*

HAVING INSTALLATION QUESTIONS? CALL TECHNICAL SUPPORT AT 1-800-798-0813

Parts List			
ITEM	QTY	PART NUMBER	DESCRIPTION
1	4	1/2-13 x 1 1/2	CARRIAGE BOLT
2	4	HFN 1213	HEX FLANGE NUT
3	4	CM-SP6	.250 x 1.00 x 3.00" SQUARE HOLE SPACER
4	4	1_2 x 30 FISHWIRE	1/2" x 30" FISHWIRE

TOOLS REQUIRED
T-15 TORXBIT SOCKET
RATCHET
SOCKET SET
PRY BAR
SPRAY LUBRICANT
CUT-OFF WHEEL
TAPE MEASURE
AVIATION SHEARS
TORQUE WRENCH

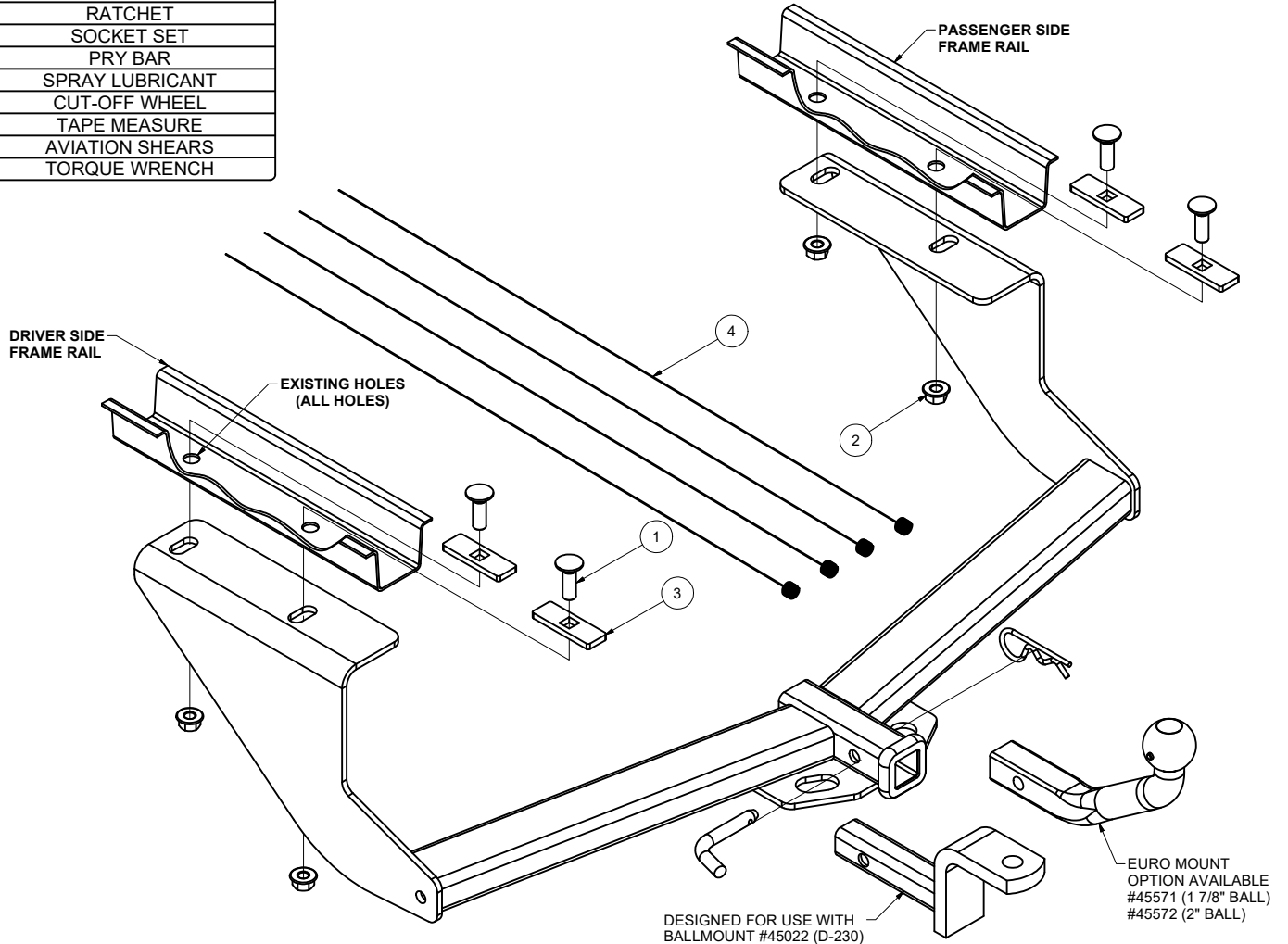

HITCH WEIGHT: 39 LBS.

**INSTALL TIME**

PROFESSIONAL: 30 MINUTES

NOVICE (DIY): 60 MINUTES

**INSTALL NOTES:**

- FISHWIRE HARDWARE
- MAY REQUIRE PANEL/ HEAT SHIELD TRIMMING

**FISHWIRE TECHNIQUE**

INSERT COILED END OF FISHWIRE TOOL THROUGH HITCH MOUNTING HOLE IN VEHICLE FRAME RAIL AND OUT THE ACCESS HOLE. PASS COILED END OF FISHWIRE THROUGH SPACER AND THREAD BOLT INTO COIL. KINK WIRE TO KEEP SPACER SEPARATE FROM BOLT AS SHOWN. PULL FISHWIRE, SPACER, AND BOLT THROUGH FRAME AND OUT MOUNTING HOLE. USE FISHWIRE TO GUIDE HITCH DURING MOUNTING AND PREVENT LOSS OF BOLT / SPACER INSIDE FRAME RAIL.

\*\*NOTE: SOME VEHICLES MAY FISHWIRE THROUGH END OF FRAME\*\*

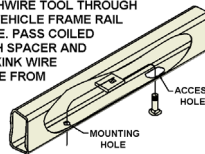

**PERIODICALLY CHECK THIS RECEIVER HITCH TO ENSURE THAT ALL FASTENERS ARE TIGHT AND THAT ALL STRUCTURAL COMPONENTS ARE SOUND.**

Curt Manufacturing LLC., warrants this product to be free of defects in material and/or workmanship at the time of retail purchase by the original purchaser. If the product is found to be defective, Curt Manufacturing LLC., may repair or replace the product, at their option, when the product is returned, prepaid, with proof of purchase. Alteration to, misuse of, or improper installation of this product voids the warranty. Curt Manufacturing LLC.'s liability is limited to repair or replacement of products found to be defective, and specifically excludes liability for incidental or consequential loss or damage.

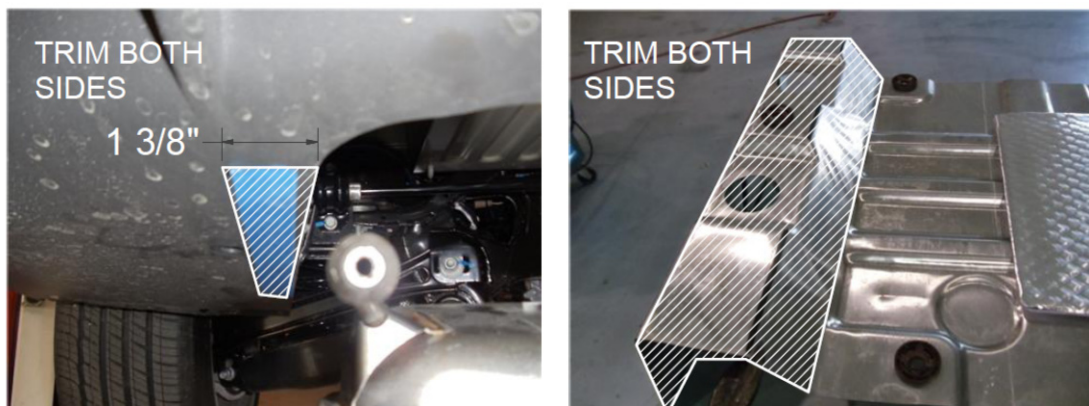

TRIM DIAGRAM

### **INSTALLATION STEPS**

1. Remove (14) screws that secure plastic fascia to bottom of vehicle. This will allow fascia to be pulled away from exhaust, and allow heat shield to be removed. Coupe models: remove fasteners with a 7mm socket.
2. Lower exhaust by first removing (2) bolts on each side from the end of the vehicle frame rails that secure the exhaust hanger brackets. Remove brackets from hanger pegs on muffler. Then remove the rubber exhaust hangers, (4) places forward of mufflers, (3) places on Coupe models.
3. It may be necessary to remove support strap to allow exhaust to hang lower and allow heat shield to be fully removed. It will be necessary to gently pull fascia downward to allow muffler pegs to be below fascia.
4. Remove heat shield by removing (8) nuts which secure it to the vehicle. Retain (6) nuts for reinstallation after heat shield trimming.
5. Cut off stud from each frame rail that secured the heat shield.
6. Mark heat shield as shown and trim to allow access to both frame rails. Reattach trimmed heat shield using (6) nuts removed in Step 4.
7. Trim vehicle fascia as shown on each side of the vehicle to allow for hitch side plate reinstallation, approximately 1-3/8" each side.
8. Fishwire 1/2" carriage bolts and spacer blocks up through slots in vehicle frame and down through attaching holes in hitch side plates, 2 places, each side.
9. Raise hitch and hitch into position simultaneously, being careful not to push bolts back into frame. Secure with 1/2" flange hex nuts. Torque all 1/2" hardware to 110 lb-ft. Reattach exhaust support strap if removed in Step 3.
10. Install complete.

**PERIODICALLY CHECK THIS RECEIVER HITCH TO ENSURE THAT ALL FASTENERS ARE TIGHT AND THAT ALL STRUCTURAL COMPONENTS ARE SOUND.**