

YEARS: 2016-PRESENT

MAKE: FORD

MODEL: FOCUS RS

STYLE: HB

**WARNING: NEVER EXCEED YOUR VEHICLE MANUFACTURER'S RECOMMENDED TOWING CAPACITY**  
 For more information log onto [www.curtmfg.com](http://www.curtmfg.com) & for helpful towing tips log onto [www.hitchinfo.com](http://www.hitchinfo.com)

**WEIGHT CARRYING:**  
 TRAILER WEIGHT: 2,000 LBS.  
 TONGUE WEIGHT: 200 LBS.

**WARNING:**  
 WE RECOMMEND THE USE OF 18050 STABILIZING STRAPS FOR ALL NON-TRAILER (WHEEL-LESS) LOADS. PLEASE SEE THE CURT CATALOG OR VISIT US ONLINE AT [WWW.CURTMFG.COM](http://WWW.CURTMFG.COM) FOR FURTHER INFORMATION.

**PRO INSTALL TIME: 45 MIN.**  
**NOVICE INSTALL TIME: 90 MIN.**

IF YOU ARE HESITANT TO UNDERTAKE THIS TASK ON YOUR OWN, CONTACT AN AUTHORIZED CURT INSTALLER FOR ADDITIONAL ASSISTANCE.

**INSTALLATION REQUIRES:**

<b>RATCHET</b>	<b>TORQUE WRENCH</b>	<b>8" SOCKET EXTENSION</b>
<b>SOCKETS</b>	<b>T-30 TORXBIT SOCKET</b>	<b>PRY BAR</b>
<b>AVIATION SHEARS</b>	<b>MASKING TAPE</b>	<b>SAFETY GLASSES</b>

**INSTALLATION TIPS:**

- BEFORE YOU BEGIN INSTALLATION, READ ALL INSTRUCTIONS THOROUGHLY.
- TO EASE INSTALLATION, 2 PEOPLE MAY BE REQUIRED.
- USING PROPER TOOLS WILL GREATLY IMPROVE THE QUALITY OF THE INSTALL AND REDUCE THE TIME REQUIRED.
- NEED HELP OR HAVE SOME QUESTIONS? CALL TECHNICAL SUPPORT AT 800.798.0813

**LEVEL OF DIFFICULTY: MODERATE**

EASY	MODERATE	CHALLENGING
NO DRILLING REQUIRED		
PART REMOVAL	TEMPORARILY REMOVE BUMPER AND REAR FASCIA	
TRIM	TRIM REAR FASCIA TRIM HEAT SHIELD	

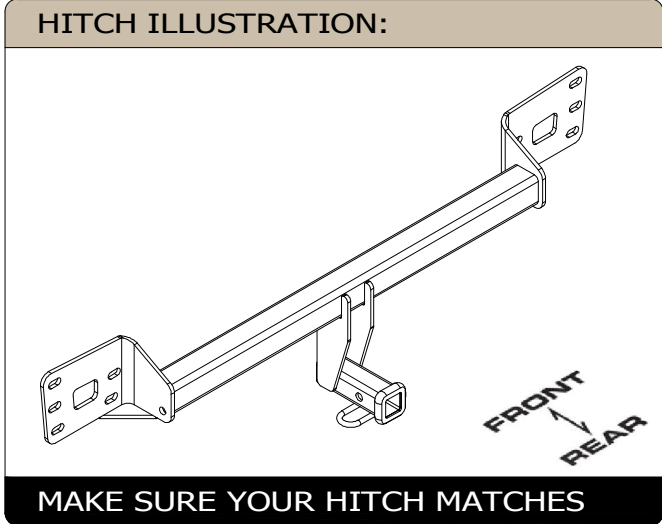

**PERIODICALLY CHECK THIS RECEIVER HITCH TO ENSURE ALL FASTENERS ARE TIGHT AND ALL STRUCTURAL COMPONENTS ARE SOUND**  
 CURT Manufacturing LLC. warrants this product to be free of defects in material and/or workmanship at the time of retail purchase by the original purchaser. If the product is found to be defective, CURT Manufacturing LLC. may repair or replace the product at their option, when the product is returned, prepaid, with proof of purchase. Alteration to, misuse of, or improper installation of this product voids the warranty. CURT Manufacturing LLC.'s liability is limited to repair or replacement of products found to be defective, and specifically excludes liability for incidental or consequential loss or damage.  
 For more information log onto [www.curtmfg.com](http://www.curtmfg.com) , & for helpful towing tips log onto [www.hitchinfo.com](http://www.hitchinfo.com)  
 This product complies with safety specifications and requirements for connecting devices and towing systems of the state of New York, V.E.S.C.Regulation V-5 and SAE J684.

## INSTALLATION WALKTHROUGH:

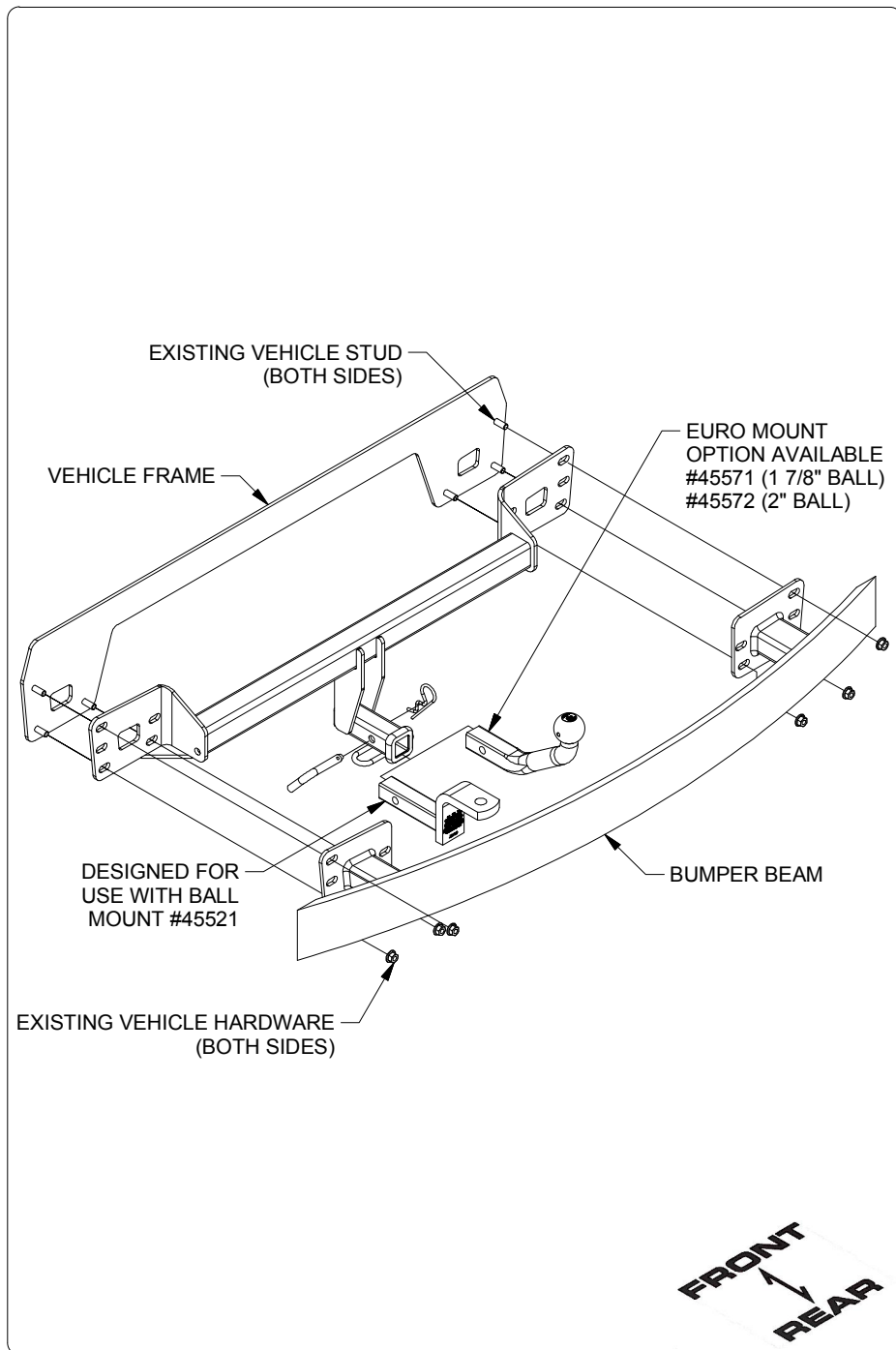

1. Located on bottom of rear fascia remove (2) screws using an 8mm socket. Along wheel well remove (6) screws, (3) on each side, using T-30 torxbit socket. Open liftgate to reveal (2) screws and remove using 7mm socket to unsecure rear fascia. Gently unclip rear fascia, unclip electrical harness and set aside for reinstallation.

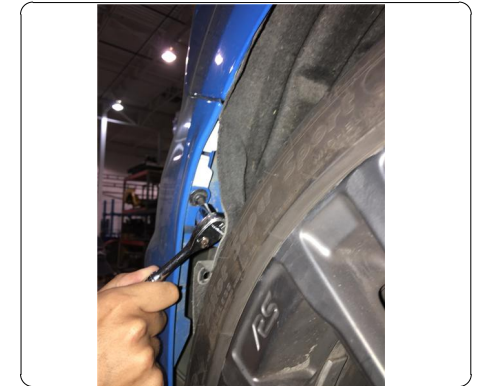

2. Remove bumper beam by removing (6) nuts using 13mm socket, (3) on each side. Set bumper beam aside for reinstallation.



## INSTALLATION WALKTHROUGH:

3. Install hitch on rear of vehicle frame using existing studs. Reinstall bumper beam over hitch. Loosely secure using existing vehicle hardware.



4. Torque all M8 hardware to 23 ft-lbs.



5. Mark out 2.25" x 2.00" section using masking tape. Trim rear fascia and trim heat shield as shown in the trim diagram using aviation shears.  
**NOTE:** All dimensions are approximate, confirm fit prior to trimming.

TRIM DIAGRAM

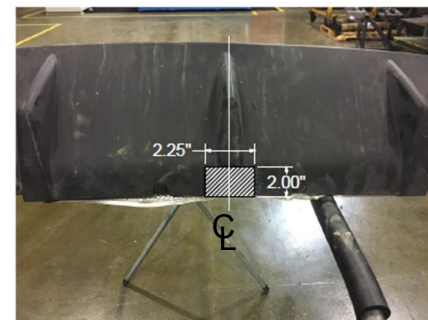

6. Reinstall rear fascia and plug in electrical removed in step 1.  
**INSTALL COMPLETE**

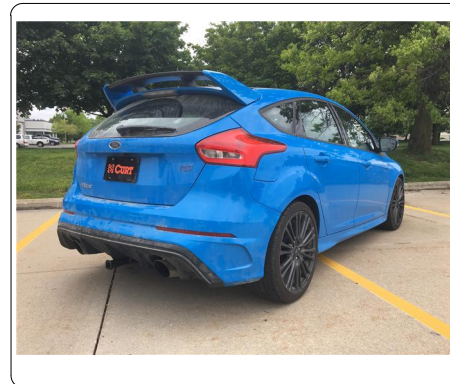

## TOWING SAFETY INFORMATION

### Gross Trailer Weight / GTW

The Gross Trailer Weight is the weight of the trailer & cargo. Measure this by putting the fully loaded trailer on a vehicle scale.



### Tongue Weight / TW

The downward force that is exerted on the hitch ball by the coupler. The tongue weight will vary depending on where the load is positioned in relationship to the trailer axle(s). To measure the tongue weight, use either a commercial scale or a bathroom scale with the coupler at towing height. When using a bathroom scale with heavier tongue weights, use the method shown and multiply the scale reading by 3.

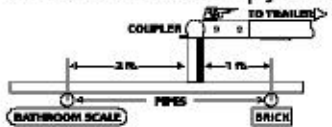

### Weight Carrying / WC

The total weight of both the trailer and the cargo inside. Never exceed the weight capacity of your trailer hitch.

### Weight Distribution / WD

Used to balance the weight of the cargo between the front and rear wheels throughout the trailer, allowing for better steering, braking, and level riding.



### Sway Control

A device used to reduce the lateral movements of the trailer that are caused by the wind. This works in conjunction with a weight distribution hitch. Do not use this on a class 1 or 2 hitch, or with surge brakes.

### How Much Can You Safely Tow?

TONGUE WEIGHT (lb.)	1500	2000	3000	4000	5000	6000	7000	8000	10,000	12,000	
CLASS 1	CLASS 1										
CLASS 2	CLASS 2										
CLASS 3	CLASS 3										
CLASS 4	CLASS 4										
CLASS 5	CLASS 5										
<b>Coupler</b>	11	12	13	14	15	16					
Inc.	1100	1200	1300	1400	1500	1600					
<b>Weight</b>	17	18	19	20	22	24	26	28	30	32	
Inc.	2100	2400	2700	3000	3300	3600	3900	4200	4500	4800	
<b>Weight</b>	14	15	16	17	18	19	20	21	22	23	
Inc.	2800	3200	3600	4000	4400	4800	5200	5600	6000	6400	
5th Wheel											

*Refer to owner's manual for towing capabilities and limitations.*

### Ball Mount

The ball mount is placed inside the opening of the receiver hitch which is mounted to the vehicle. Make sure a hitch pin and clip is properly securing the ball mount to the receiver hitch before you begin towing.

- A: Rise. B: Drop. C: Hole Size. D: Length.

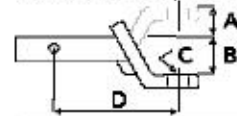

### Trailer Ball

The connection from the hitch to the trailer. There are many factors that determine the correct hitch ball:

- Number one is the hitch ball's gross trailer weight rating.
- The mounting platform must be at least 3/8" thick.
- The hole diameter must not be more than 1/16" larger than the threaded shank.
- Every time you tow, check the nut and lock washer to make sure they are fastened securely.
- A: Ball Dia. B: Shank Length. C: Shank Dia. D: Shank Rise.

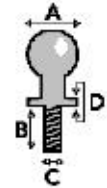

### Coupler

The component that is placed over the trailer ball to connect the vehicle to the trailer. Be sure that the coupler size matches the size of the hitch ball and that the coupler handle is securely fastened. To determine what size hitch ball you need for your application you will need to know the size of coupler that is on the trailer. Be sure your coupler is properly adjusted to the ball you are using.

NOTE: For added security the use of safety devices such as Coupler Safety Pins and Locks is strongly recommended.

### Safety Chains

Safety chains are a requirement and should be crossed under the tongue of the trailer so that the tongue will not drop to the road if it becomes separated from the hitch. Always leave enough slack so you can turn. Never allow the safety chains to drag on the ground and never attach the chains to the bumper.

Trailer Classification: Safety Chain Breaking Force - Minimum

Class 1: 2,000 lbs. (8.9 kN)

Class 2: 3,500 lbs. (15.6 kN)

Class 3: 5,000 lbs. (22.2 kN)

The strength rating of each length of safety chain or its equivalent and its attachments shall be equal to or exceed in minimum breaking force the GVWR (Gross Vehicle Weight Rating) of the trailer.

### Electrical

Trailer lights, Electric Brakes, Break-away systems - Every time you tow, be sure to check that all components are working properly.

Wiring identification by color:

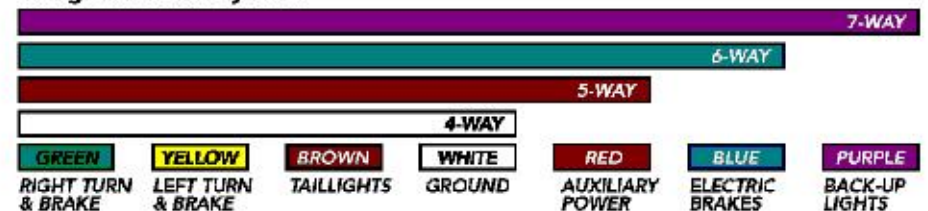

CURT DISCLAIMER: WIRING COLOR SHOWN WORK IN CONJUNCTION WITH CURT MANUFACTURING PRODUCTS.

11489

# FORD FOCUS RS

6/15/2017

GROSS LOAD CAPACITY WHEN USED AS A WEIGHT CARRYING HITCH: 2,000 LBS. TRAILER WEIGHT & 200 LBS. TONGUE WEIGHT.



**WARNING: \*\*\* DO NOT EXCEED VEHICLE MANUFACTURER'S RECOMMENDED TOWING CAPACITY. \*\*\***

FOR MORE INFORMATION LOG ONTO [WWW.CURTMFG.COM](http://WWW.CURTMFG.COM) & FOR HELPFUL TOWING TIPS LOG ONTO [WWW.HITCHINFO.COM](http://WWW.HITCHINFO.COM)  
HAVING INSTALLATION QUESTIONS? CALL TECHNICAL SUPPORT AT 1-800-798-0813

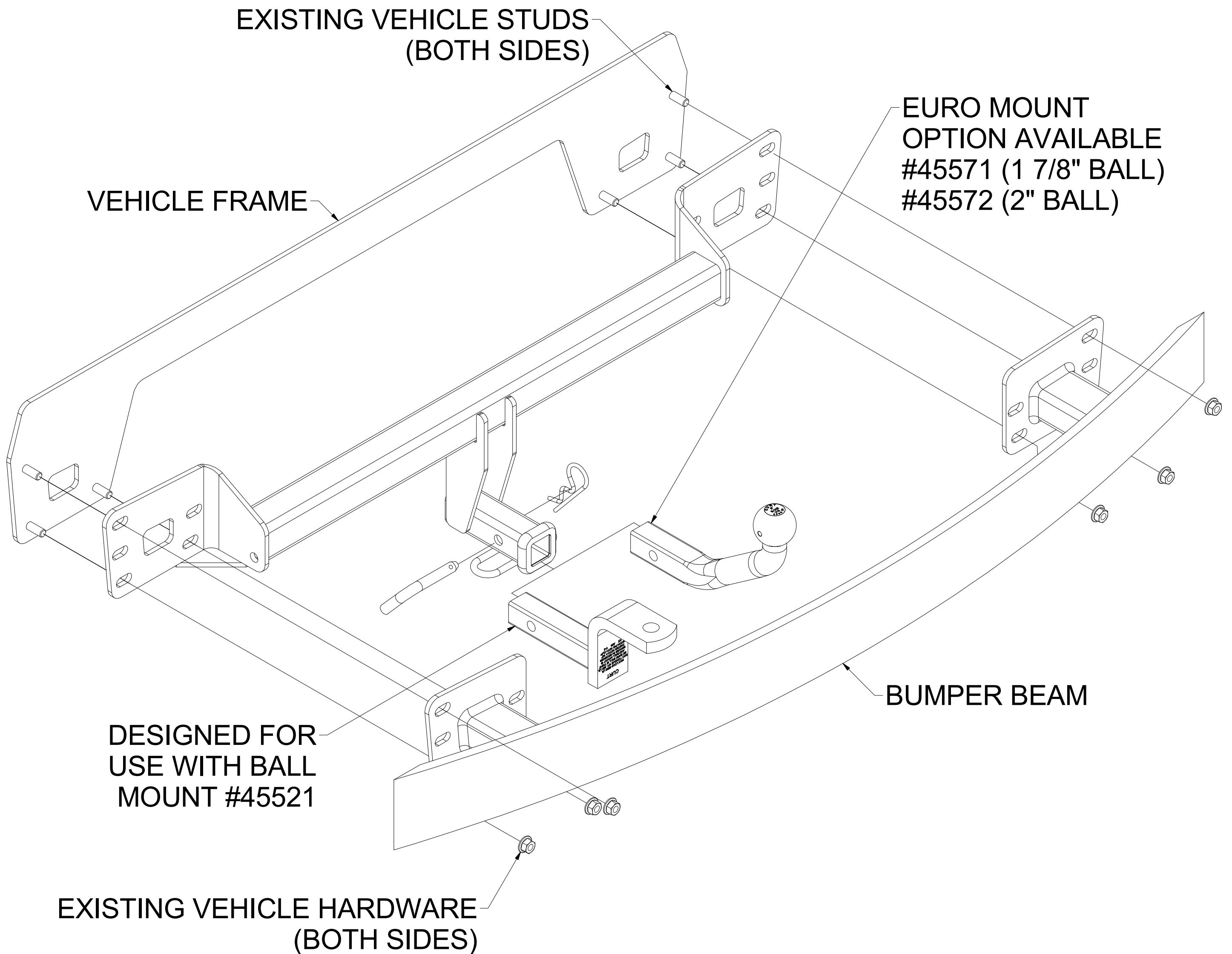

HITCH WEIGHT: 28 LBS.

**INSTALL TIME**

PROFESSIONAL: 45 MINUTES

NOVICE (DIY): 90 MINUTES

**INSTALL NOTES:**

- NO DRILLING REQUIRED
- TEMPORARILY REMOVE BUMPER AND REAR FASCIA
- TRIM REAR FASCIA AND HEAT SHIELD

**TOOLS REQUIRED**

RATCHET
TORQUE WRENCH
SOCKET EXTENSION
7mm, 8mm, 13mm SOCKETS
T-30 TOXBIT SOCKET
PRY BAR
AVIATION SHEARS
MASKING TAPE
SAFETY GLASSES



Scan for more information

**PERIODICALLY CHECK THIS RECEIVER HITCH TO ENSURE THAT ALL FASTENERS ARE TIGHT AND THAT ALL STRUCTURAL COMPONENTS ARE SOUND.**

CURT Manufacturing LLC., warrants this product to be free of defects in material and/or workmanship at the time of retail purchase by the original purchaser. If the product is found to be defective, CURT Manufacturing LLC., may repair or replace the product, at their option, when the product is returned, prepaid, with proof of purchase. Alteration to, misuse of, or improper installation of this product voids the warranty. CURT Manufacturing LLC.'s liability is limited to repair or replacement of products found to be defective, and specifically excludes liability for incidental or consequential loss or damage.

This product complies with safety specifications and requirements for connecting devices and towing systems of the state of New York, V.E.S.C.Regulation V-5 and SAE J684.

## TRIM DIAGRAM

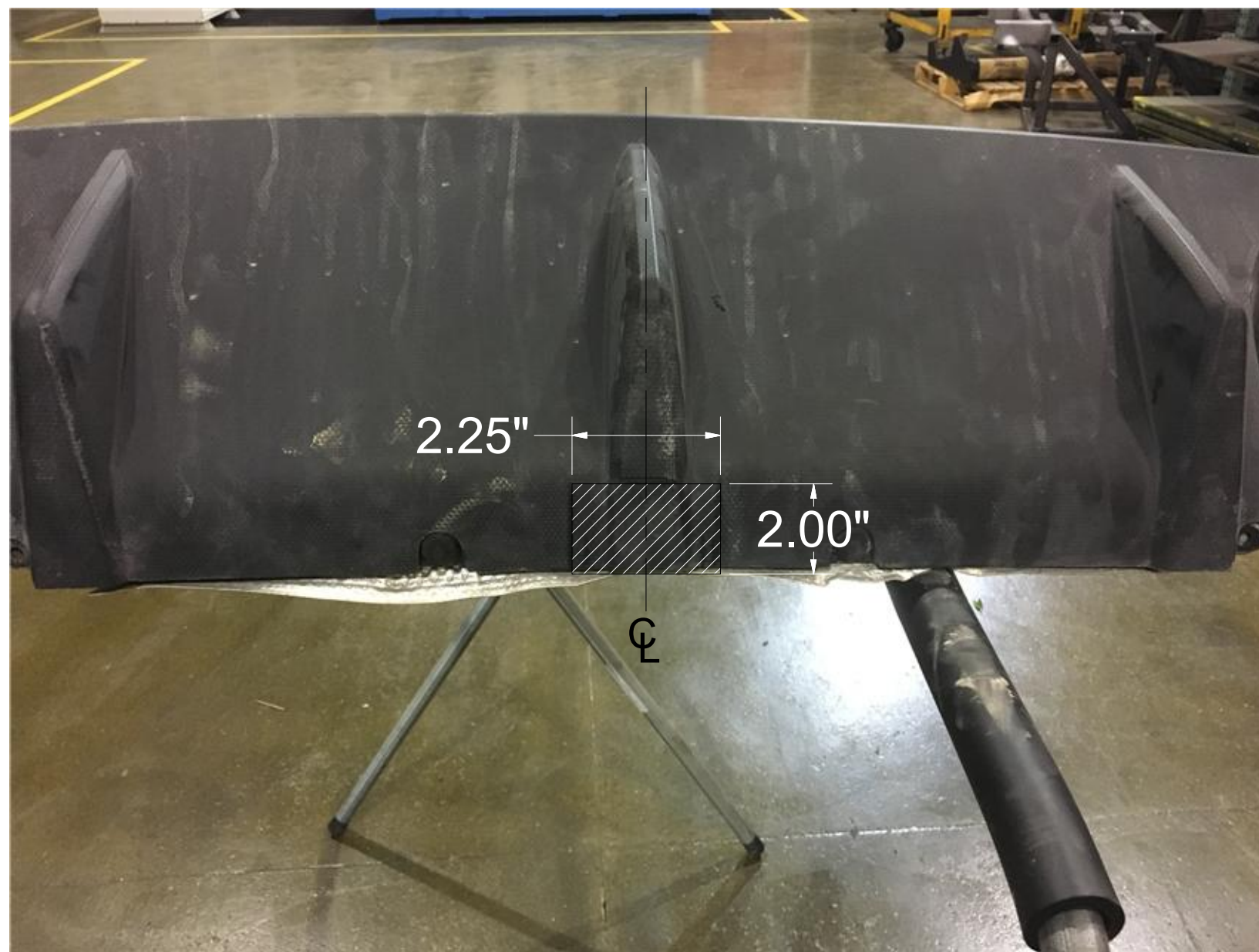

### **INSTALLATION STEPS**

1. Located on bottom of rear fascia remove (2) screws using an 8mm socket. Along wheel well remove (6) screws, (3) on each side, using T-30 torxbit socket. Open liftgate to reveal (2) screws and remove using 7mm socket to unsecure rear fascia. Gently unclip rear fascia, unclip electrical harness and set aside for reinstallation.
2. Remove bumper beam by removing (6) nuts using 13mm socket, (3) on each side. Set bumper beam aside for reinstallation.
3. Install hitch on rear of vehicle frame using existing studs. Reinstall bumper beam over hitch. Loosely secure using existing vehicle hardware.
4. Torque all M8 hardware to 23 ft-lbs.
5. Mark out 2.25" x 2.00" section using masking tape. Trim rear fascia and trim heat shield as shown in the trim diagram using aviation shears.  
**NOTE:** All dimensions are approximate, confirm fit prior to trimming.
6. Reinstall rear fascia removed and plug in electrical removed in step 1.

INSTALL COMPLETE

**PERIODICALLY CHECK THIS RECEIVER HITCH TO ENSURE THAT ALL FASTENERS ARE TIGHT AND THAT ALL STRUCTURAL COMPONENTS ARE SOUND.**