

11558**84-86 NISSAN 300ZX**

12/10/2012

GROSS LOAD CAPACITY WHEN USED AS A WEIGHT CARRYING HITCH: 1,500 LBS. TRAILER WEIGHT & 150 LBS. TONGUE WEIGHT.

*****DO NOT EXCEED VEHICLE MANUFACTURER'S RECOMMENDED TOWING CAPACITY.*****

WARNING: ALL NON-TRAILER LOADS APPLIED TO THIS PRODUCT MUST BE SUPPORTED BY 18050 STABILIZING STRAPS.

**** FAILURE TO PROPERLY SUPPORT NON-TRAILER LOADS WILL VOID PRODUCT WARRANTY****

HAVING INSTALLATION QUESTIONS? CALL TECHNICAL SUPPORT AT 1-877-287-8634

Parts List			
ITEM	QTY	PART NUMBER	DESCRIPTION
1	2	3/8"	LOCK WASHER
2	2	3/8 - 16	HEX NUT
3	2	3/8"	WASHER
4	6	3/8 - 16 x 1 1/4	HEX BOLT
5	4	3/8"	FENDER WASHER
6	4	3/8-16	NYLOCK HEX NUT

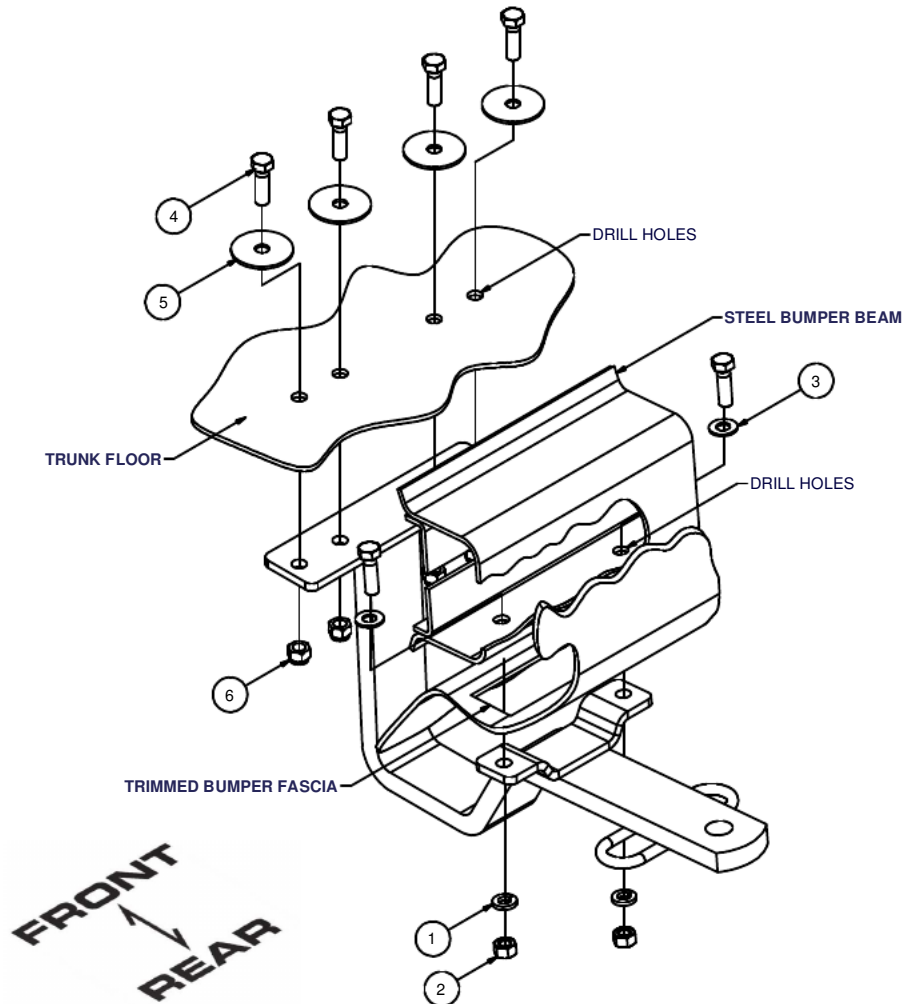

HITCH WEIGHT: 11 LBS.

INSTALL TIME

PROFESSIONAL: 45 MINUTES

NOVICE (DIY): 90 MINUTES

INSTALL NOTES:

- DRILLING REQUIRED
- TRIM BUMPER FASCIA
- SILICONE SEAL HARDWARE

INSTALLATION STEPS

1. Locate and mark the vehicle's centerline at the rear bumper. Cut away the bumper covering at the bottom of bumper enough to fit the hitch against the steel inner bumper. Inside the vehicle's trunk, lift any floor covering away where the hitch will fasten to the trunk floor.
2. Hold the hitch in position on the bumper and trunk floor, and mark (6) places for hitch bolts. Centerpunch and drill the vehicle for 3/8" diameter bolts.
3. Mount the hitch using the fasteners called out in the diagram. Note that all washers are positioned on the opposite side of mounting points from the hitch. Do not overtighten lock nuts at the floor.
4. Torque all 3/8" fasteners to 45 lb-ft.
5. Use silicone sealant to seal hardware installed through trunk floor.
6. Reinstall trunk floor covering.

PERIODICALLY CHECK THIS RECEIVER HITCH TO ENSURE THAT ALL FASTENERS ARE TIGHT AND THAT ALL STRUCTURAL COMPONENTS ARE SOUND.

Curt Manufacturing Inc., warrants this product to be free of defects in material and/or workmanship at the time of retail purchase by the original purchaser. If the product is found to be defective, Curt Manufacturing Inc., may repair or replace the product, at their option, when the product is returned, prepaid, with proof of purchase. Alteration to, misuse of, or improper installation of this product voids the warranty. Curt Manufacturing Inc.'s liability is limited to repair or replacement of products found to be defective, and specifically excludes liability for incidental or consequential loss or damage.