

11716**90-94 VOLKSWAGEN CORRADO**

12/17/2012

GROSS LOAD CAPACITY WHEN USED AS A WEIGHT CARRYING HITCH: 2,000 LBS. TRAILER WEIGHT & 200 LBS. TONGUE WEIGHT.

*****DO NOT EXCEED VEHICLE MANUFACTURER'S RECOMMENDED TOWING CAPACITY.*******WARNING: ALL NON-TRAILER LOADS APPLIED TO THIS PRODUCT MUST BE SUPPORTED BY 18050 STABILIZING STRAPS.****** FAILURE TO PROPERLY SUPPORT NON-TRAILER LOADS WILL VOID PRODUCT WARRANTY****

HAVING INSTALLATION QUESTIONS? CALL TECHNICAL SUPPORT AT 1-877-287-8634

Parts List			
ITEM	QTY	PART NUMBER	DESCRIPTION
1	4	M10 - 1.5 x 100 HEX	HEX BOLT
2	4	3/8"	WASHER
3	4	7/16 LOCK WASHER	HELICAL LOCK WASHER

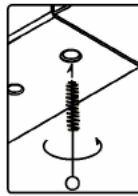
**WELDNUT CLEANING**

To remove debris from weldnuts in frame, spray lubricant or compressed air into hole. For heavy debris, use a small wire brush. (Be careful not to damage threads).

RUBBER ISOLATOR REMOVAL DIAGRAM

This technique can be used if and Exhaust Hanger Removal Pliers is not available.

Using a 5/8" open end wrench, slide the wrench up to the rubber isolator, cradling the hanger rod as shown. Next place the flat edge of a pry bar between the wrench and the hanger stop or hanger rod. Then simply rotate the pry bar toward the wrench to remove the rubber isolator.

Note: Using a spray lubricant or soapy water on the hanger rod and the rubber isolator helps removal.

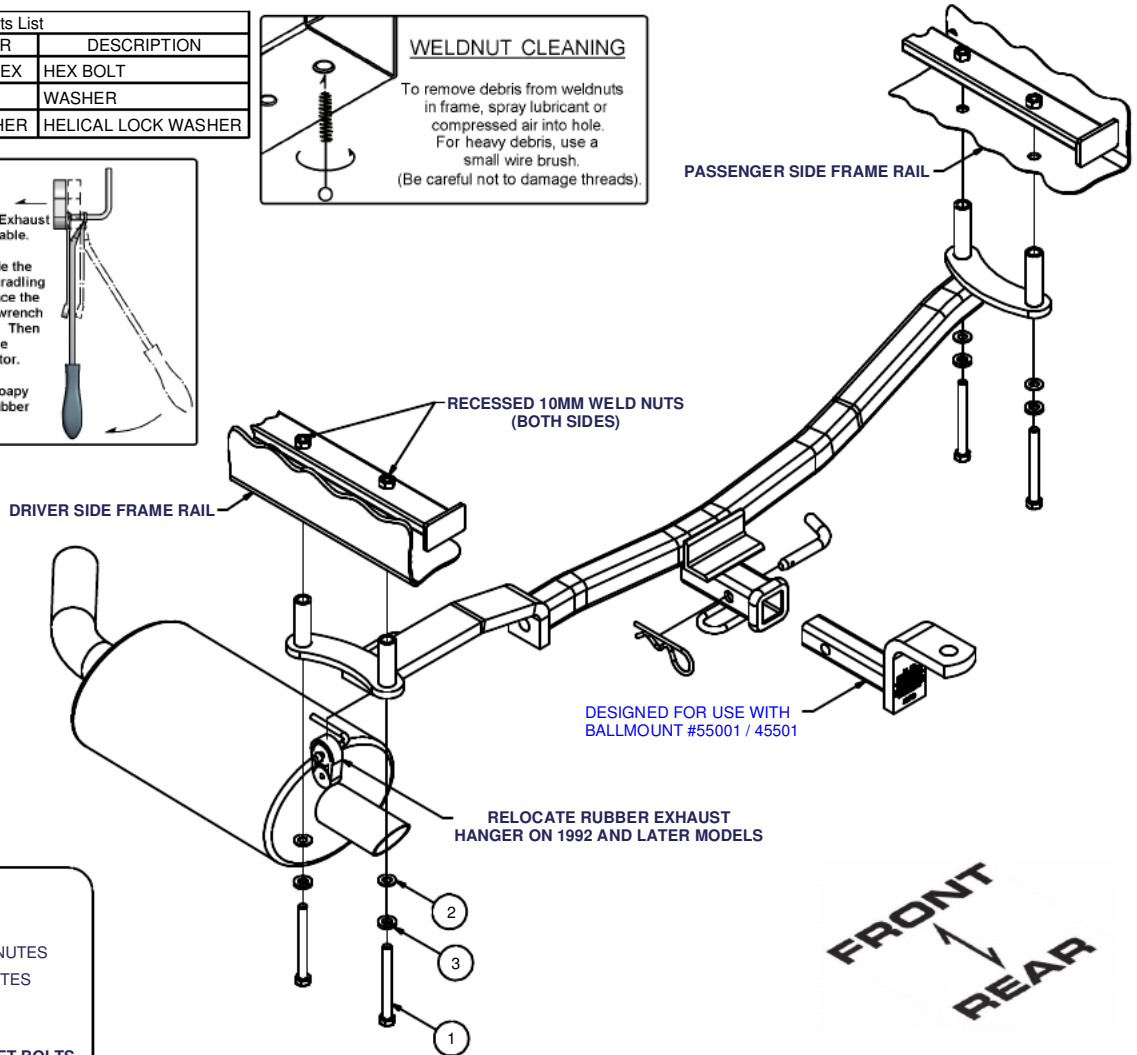

HITCH WEIGHT: 22 LBS.

INSTALL TIME

PROFESSIONAL: 20 MINUTES

NOVICE (DIY): 40 MINUTES

INSTALL NOTES:

- NO DRILLING REQUIRED
- REMOVE BUMPER BRACKET BOLTS
- LOWER EXHAUST

INSTALLATION STEPS

1. Under the rear of the vehicle on both sides, there are (2) circular cut-outs with a recessed 10mm bumper bracket bolts.
2. Remove both bumper bracket bolts on each side. Position the hitch on the vehicle as shown. Work the hitch above the exhaust pipe on the driver side. Using fasteners provided, mount the hitch at the rear bumper bracket holes so that the hitch and bumper brackets are tight to the chassis. Be certain to use washers as shown. Be careful not to cross thread the mounting bolts in the bumper bracket. Lubricating the threads may help.
3. ON 1992 AND LATER MODELS: Rear exhaust hanger rubber loop will mount to a 7/16" diameter hanger welded to the hitch. Removal of the metal bracket at the top of the loop is necessary. This can be removed by grinding away the head of the retaining pin and removing it. Install the new hanger on the hitch.
4. Torque all 10mm fasteners to 45 lb-ft.

PERIODICALLY CHECK THIS RECEIVER HITCH TO ENSURE THAT ALL FASTENERS ARE TIGHT AND THAT ALL STRUCTURAL COMPONENTS ARE SOUND.

Curt Manufacturing Inc., warrants this product to be free of defects in material and/or workmanship at the time of retail purchase by the original purchaser. If the product is found to be defective, Curt Manufacturing Inc., may repair or replace the product, at their option, when the product is returned, prepaid, with proof of purchase. Alteration to, misuse of, or improper installation of this product voids the warranty. Curt Manufacturing Inc.'s liability is limited to repair or replacement of products found to be defective, and specifically excludes liability for incidental or consequential loss or damage.