

1601-0335, 1601-0335B

5" OVAL BAR CURVED

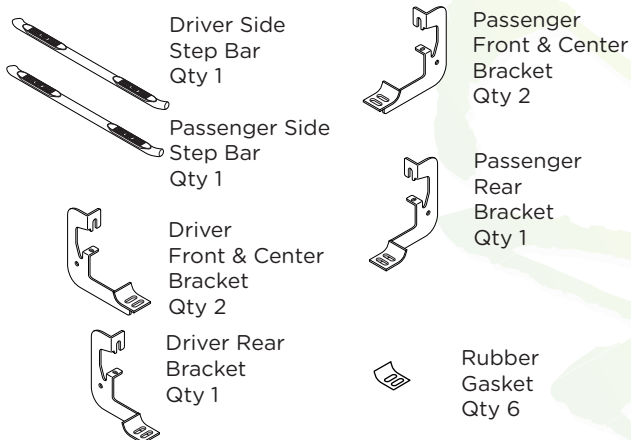

Components:



Hardware:



Tools Required:

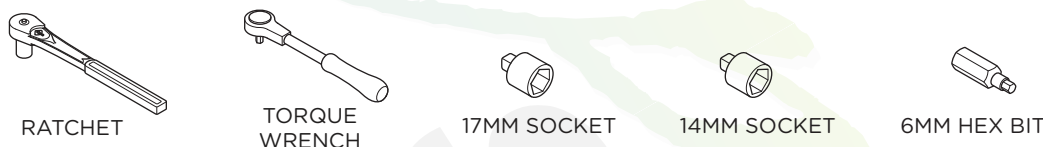

Torque Specifications:

For Rocker Panel Mount Installations
M8 through M12 bolts and nuts are set to 15-20 ft lbs.

Note: When installing the brackets and bars, all hardware must be left loose until all the items are attached.

1. Remove all contents from the package and check stainless steel tubes for any damage. Also, verify that all components and hardware listed above are included before you begin installation.
2. Read installation manual and installation drawing completely. Understand all brackets and bolts before installation.
3. Begin installation on the drivers's side. Front and Center Bracket Cradle face to the rear of truck and Rear Bracket Cradle faces to front of truck.

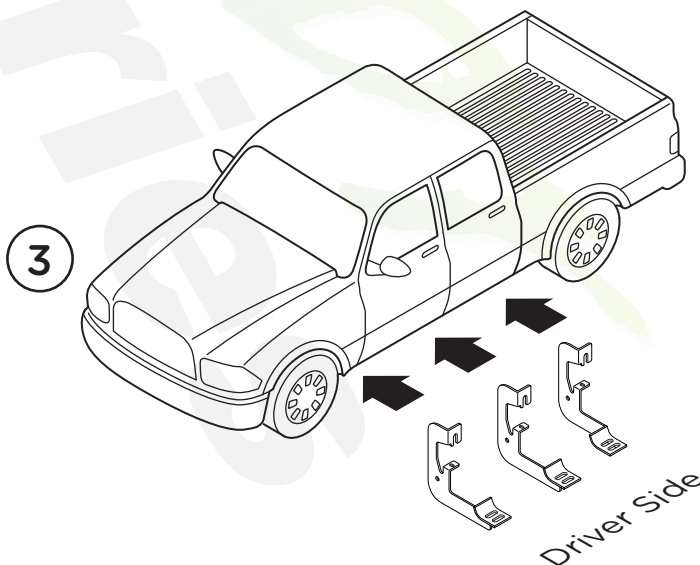

4. Existing mounting holes are located on the interior wall of the rocker panel. These mounting holes will be used per the following instruction.

Front

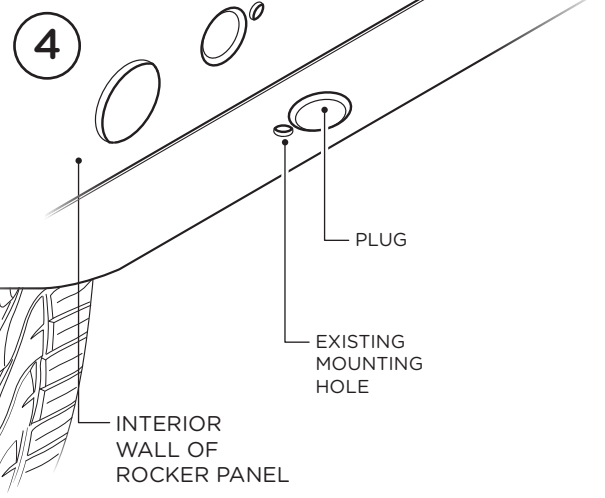

5. Remove the (2) plastic plugs from all (3) mounting locations in the rocker panel. Front Center and Rear. Insert M8 U Nut Clips so that the threads are on the inside of the rocker panel.

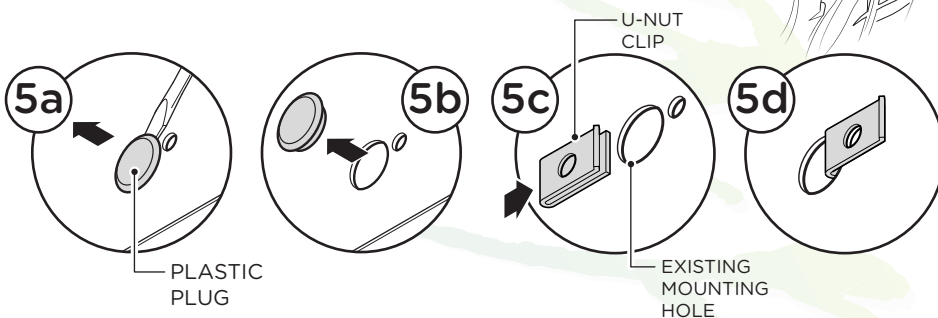

6. Fasten each bracket using two (2) M8 x 30MM Hex Head Bolts, two (2) M8 Flat Washers, two (2) M8 Lock Washers.

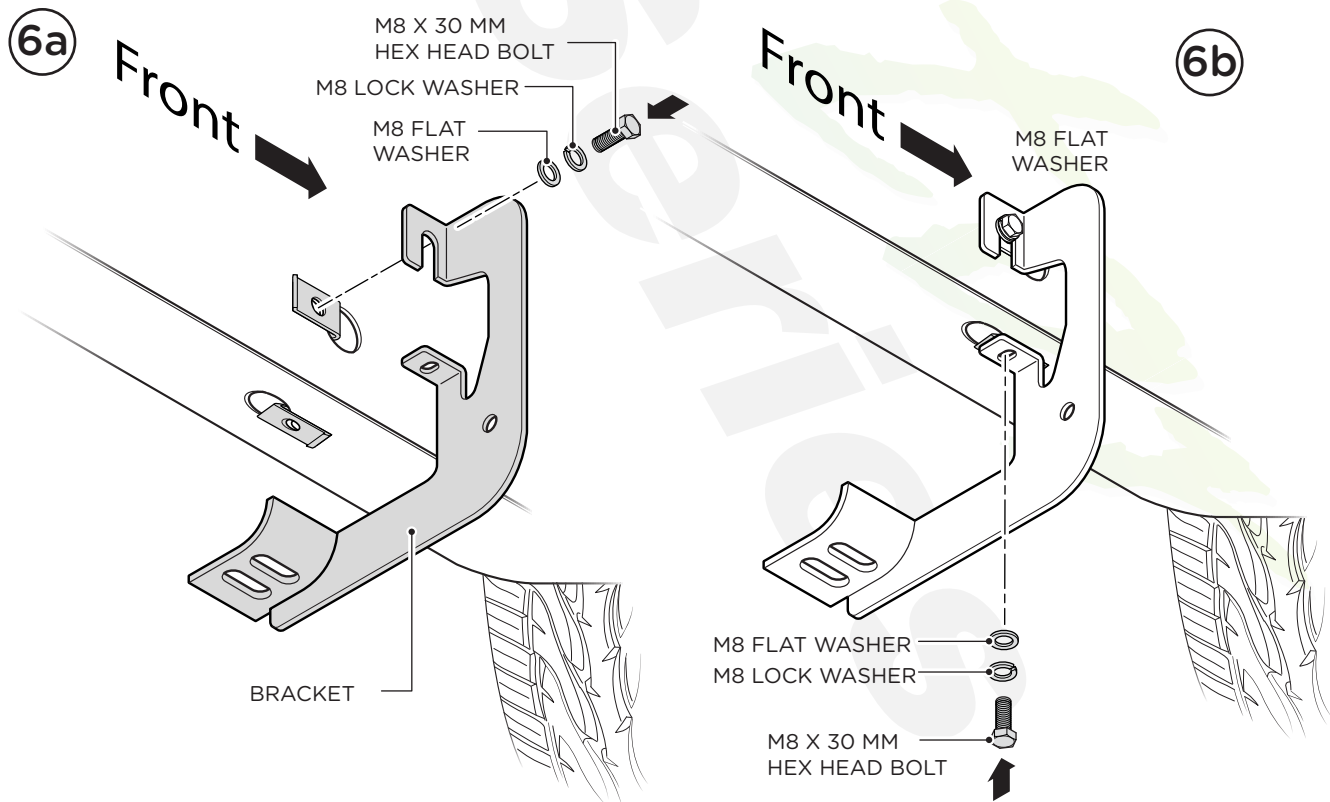

7. Place the Rubber Gaskets onto each bracket. Then, place the Step Bar onto the Brackets. Each Step Bar is marked Driver and Passenger.

8. Secure the Step Bar to each Bracket using two (2) M10 x 30MM Hex Head Bolts and two (2) M10 Lock Washer and two (2) M10 Flat Washers per bracket.

Tighten until the split lock washer is flat against bracket and snug. DO NOT over tighten and strip the threaded insert in the tube.

Repeat these steps for passenger side installation. When all hardware is in place, everything must be tightened. See Page 1 for Torque Specifications.

