

1602-0482, 1602-0482B

5" OVAL CURVED BAR



Components:



Driver Side Step Bar Qty 1

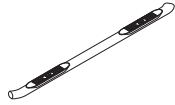

Passenger Side Step Bar Qty 1



Rubber Gaskets Qty 6

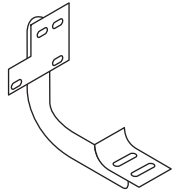

Driver Side Brackets Qty 3

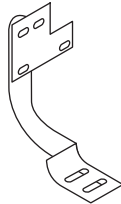

Passenger Side Front/Center Brackets Qty 2

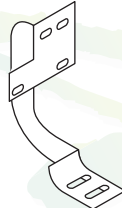

Passenger Side Rear Bracket Qty 1

Hardware:



M10 x 30mm Button Head Bolts Qty 12



M8 Flat Washers Qty 18



M10 Flat Washers Qty 12



M8 Lock Washers Qty 18



M10 Lock Washers Qty 12



M8 Hex Head Nuts Qty 18

Tools Required:

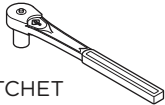

RATCHET



TORQUE WRENCH



13MM SOCKET



6MM HEX BIT

Torque Specifications:

For Rocker Panel Mount Installations
M8 through M12 bolts and nuts are set to 15-20 ft lbs.

Note: When installing the brackets and bars, all hardware must be left loose until all the items are attached.

1. Remove all contents from the package and check running boards for any damage. Also, verify that all components and hardware listed above are included before you begin installation.

Begin on driver side of vehicle.

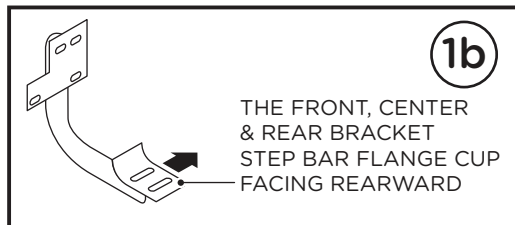
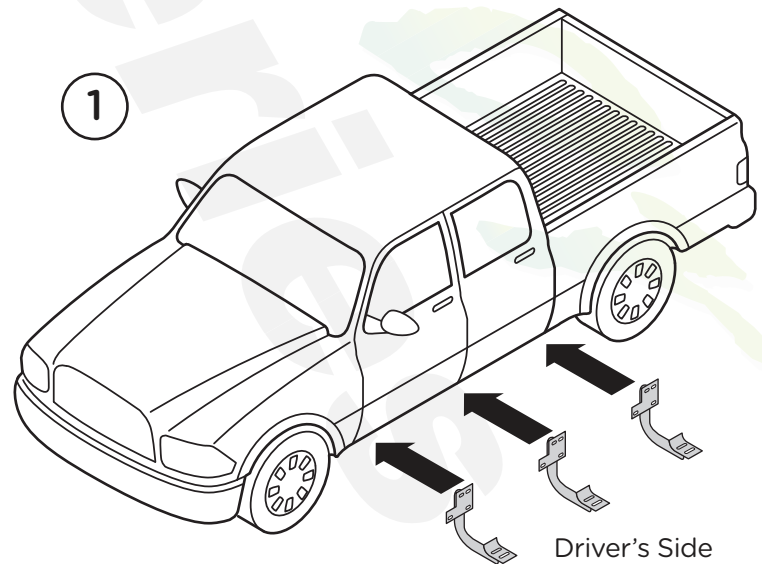

2. Existing mounting studs are located on the interior wall of the rocker panel. These mounting studs will be used for the following instruction

3. On the driver side of the vehicle, align the Front, Center and Rear brackets as shown.

Place each bracket onto the existing mounting studs on the rocker panel.

Fasten by using three (3) M8 Flat Washers, three (3) M8 Lock Washers and three (3) M8 Hex Head Nuts per bracket.

When all hardware is in place, everything must be tightened. See page 1 for torque specifications.

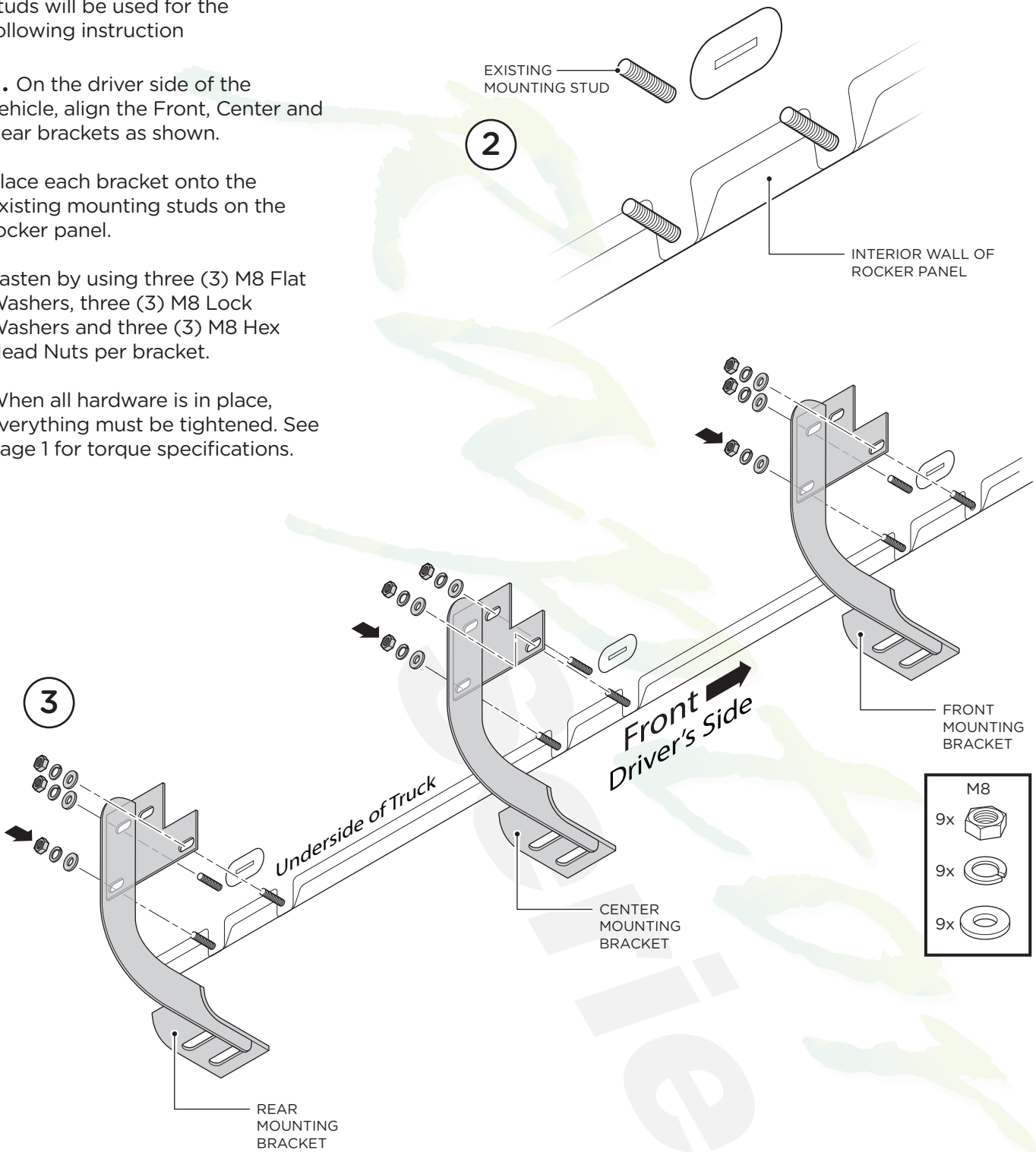

4. On the passenger side of the vehicle, align the Front, Center and Rear brackets as shown.

Place each bracket onto the existing mounting studs on the rocker panel.

Fasten by using three (3) M8 Flat Washers, three (3) M8 Lock Washers and three (3) M8 Hex Head Nuts per bracket.

5. When all hardware is in place, everything must be tightened. See page 1 for torque specifications.

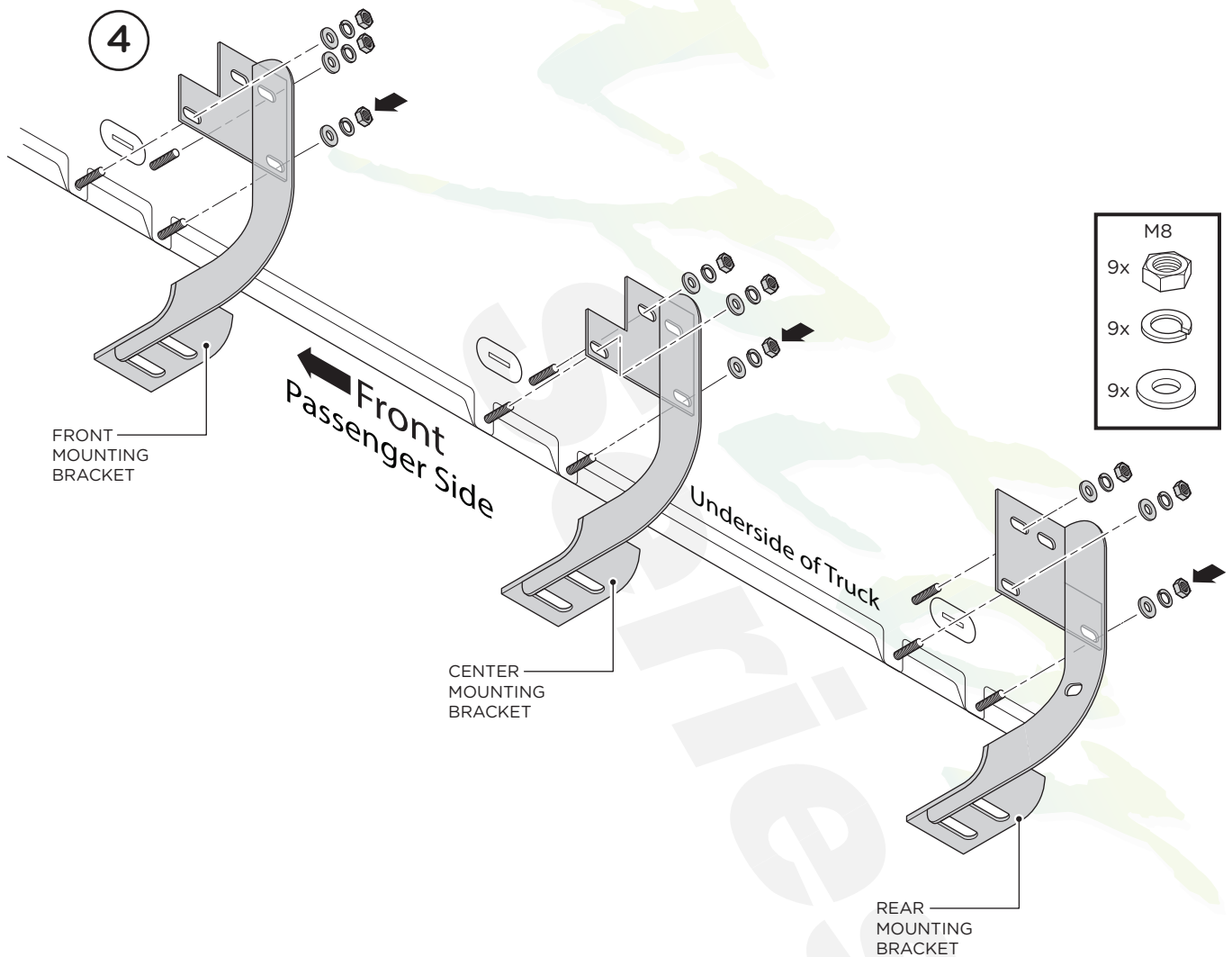

6. Place the Step Bar and Rubber Gaskets onto the Brackets. Each Step Bar is marked Driver and Passenger.

7. Install the Step Bar onto each Bracket using two (2) M10 X 30MM Button Head Bolts, two (2) M10 Lock Washers and two (2) M10 Flat Washers.

Tighten until the split lock washer is flat against bracket and snug. DO NOT over tighten and strip the threaded insert in the tube.

Repeat these steps for passenger side installation. When all hardware is in place, everything must be tightened. See Page 1 for Torque Specifications.

