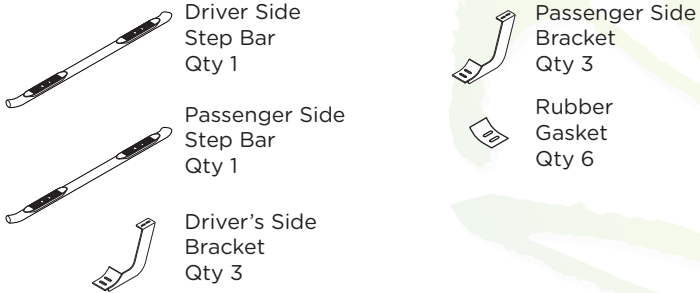
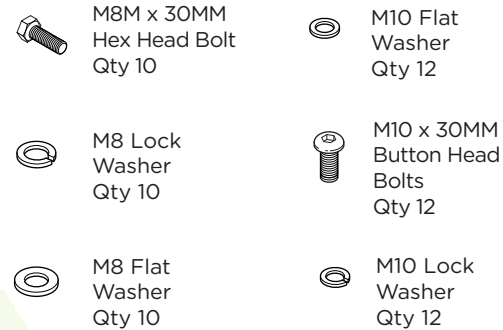
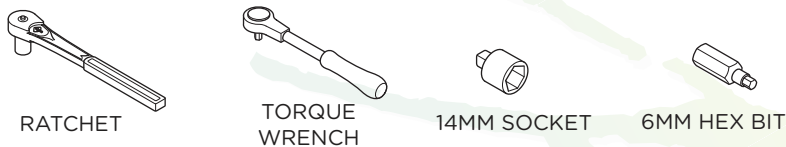

1604-0068, 1604-0068B

5" OVAL BAR CURVED*Raptor*
Series**Components:****Hardware:****Tools Required:****Torque Specifications:**

For Rocker Panel Mount Installations
M8 through M12 bolts and nuts are set to 15-20 ft lbs.

Note: When installing the brackets and bars, all hardware must be left loose until all the items are attached.

1. Remove all contents from the package and check stainless steel tubes for any damage. Also, verify that all components and hardware listed above are included before you begin installation.

2. Read installation manual and installation drawing completely. Understand all brackets and bolts before installation.

3. Begin installation on the passenger side. Align **Brackets** as shown.

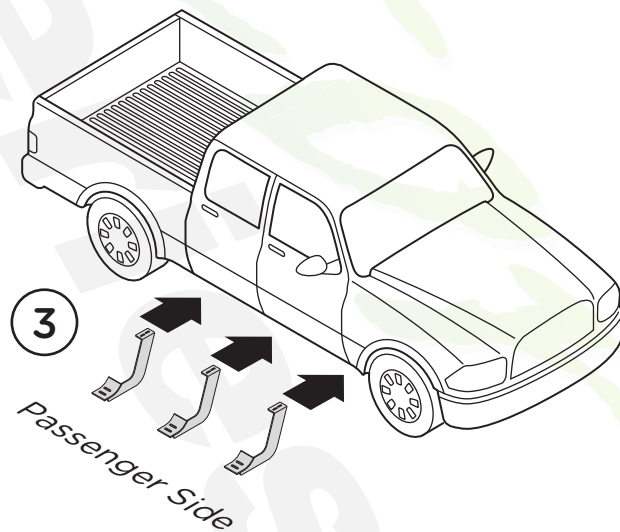

4. All passenger side Brackets are identical with the bracket cradle facing toward the rear of the vehicle. Install the first passenger side Bracket closest to the front wheel. Align with existing factory holes in the rocker panel as shown (4a), Secure the first Bracket using one (1) M8 x 30mm Hex Bolt, one (1) M8 Lock Washer and one (1) M8 Flat Washer (4b).

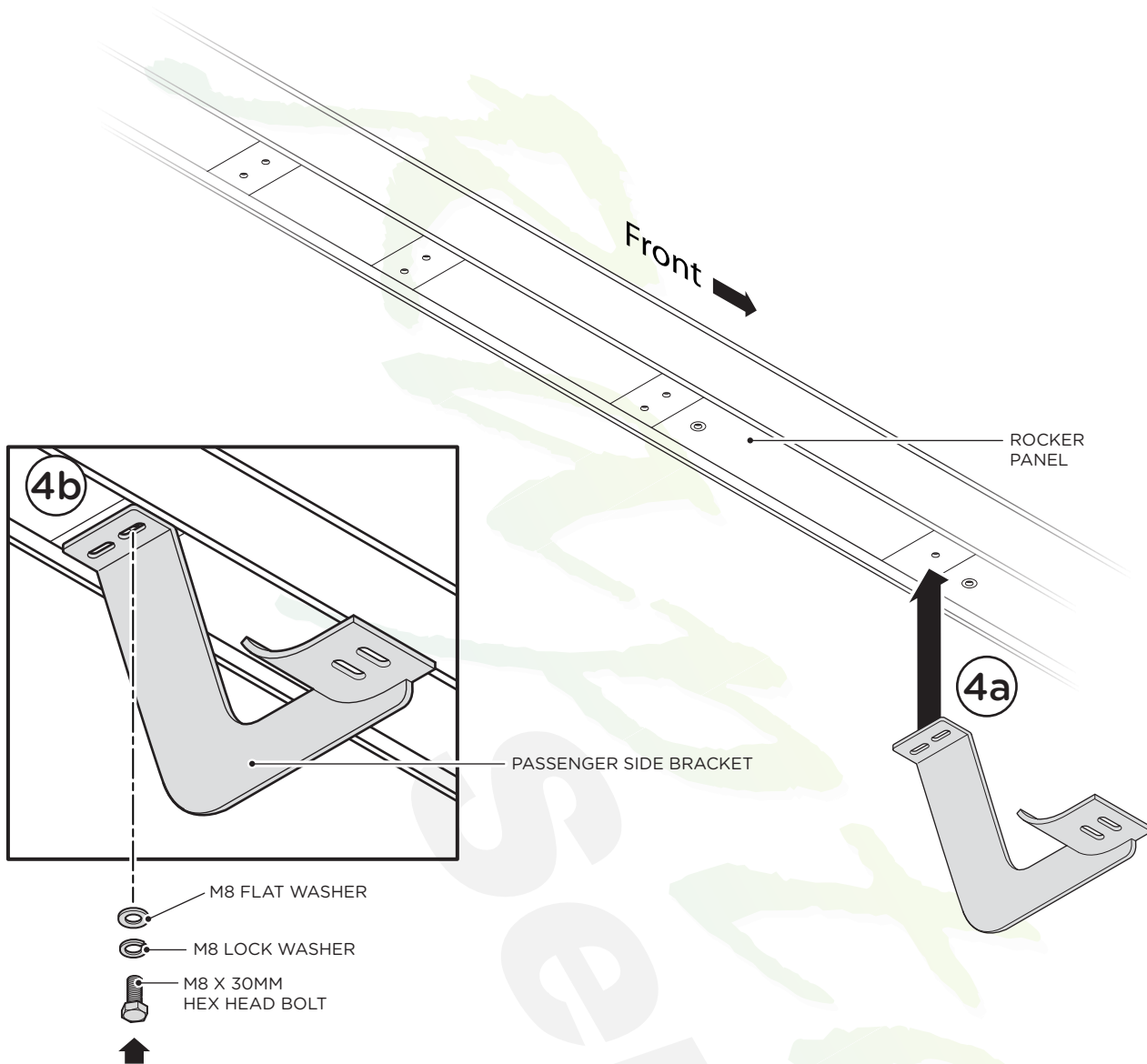

5. Position the remaining two (2) passenger side Brackets as shown (5a) and secure using two (2) M8 x 30mm Hex Bolts, two (2) M8 Lock Washers and two (2) M8 Flat Washers per Bracket (5b).

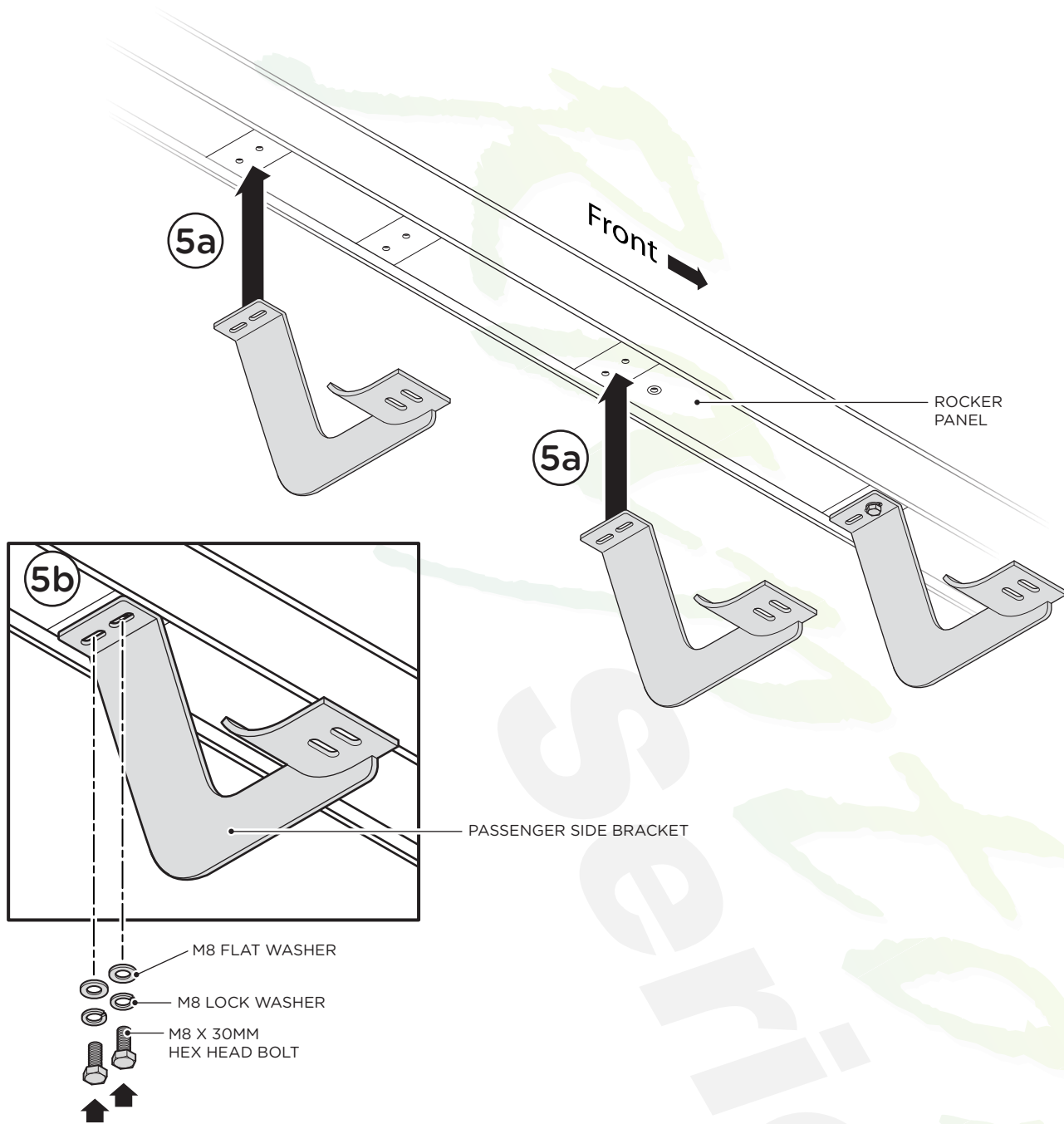

6. Place the Rubber Gaskets onto the Brackets. Then, place the Step Bar onto the Brackets. Each Step Bar is marked Driver and Passenger.

7. Secure the Step Bar to each Bracket using two (2) M10 x 30MM Button Head Bolts and two (2) M10 Lock Washers and two (2) M10 Flat Washers per bracket.

Tighten until the split lock washer is flat against bracket and snug. DO NOT over tighten and strip the threaded insert in the tube.

Repeat these steps for passenger side installation. When all hardware is in place, everything must be tightened. See Page 1 for Torque Specifications.

