

1604-0260, 1604-0260B

5" OVAL BAR CURVED

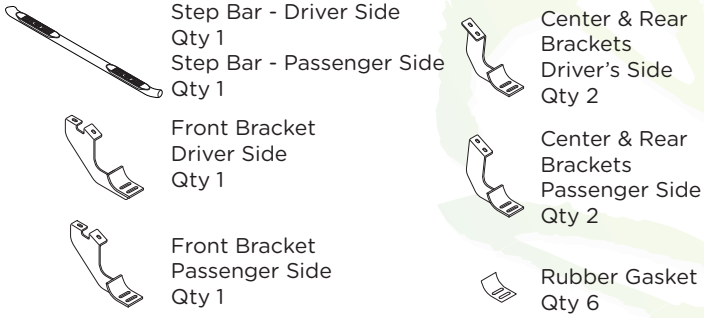

Components:



Hardware:

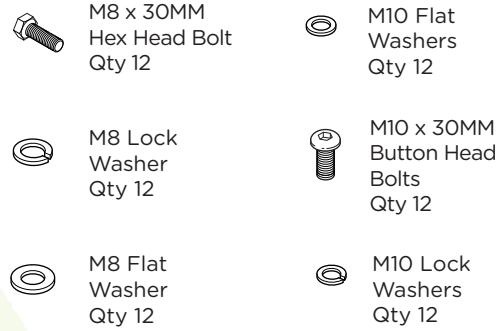

Tools Required:

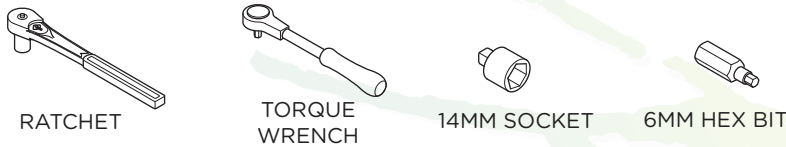

Torque Specifications:

For Rocker Panel Mount Installations
M8 through M12 bolts and nuts are set to 15-20 ft lbs.

Note: When installing the brackets and bars, all hardware must be left loose until all the items are attached.

1. Remove all contents from the package and check stainless steel tubes for any damage. Also, verify that all components and hardware listed above are included before you begin installation.

2. Read installation manual and installation drawing completely. Understand all brackets and bolts before installation.

3. Begin installation on the driver's side. Align Brackets as shown.

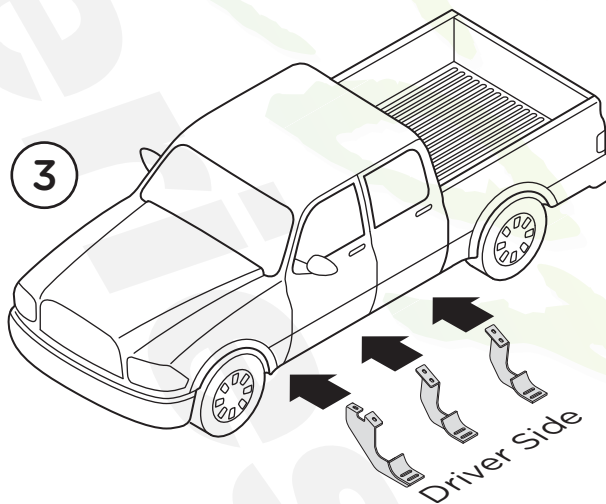

4. Align the Front, Center and Rear Driver's Side Brackets with the indicated holes located on the Rocker Panel of the vehicle.

5. Fasten the Front, Center and Rear Brackets to the Rocker Panel using two (2) M8 x 30MM Hex Head Bolts, two (2) M8 Flat Washers and two (2) M8 Lock Washers per bracket as shown.

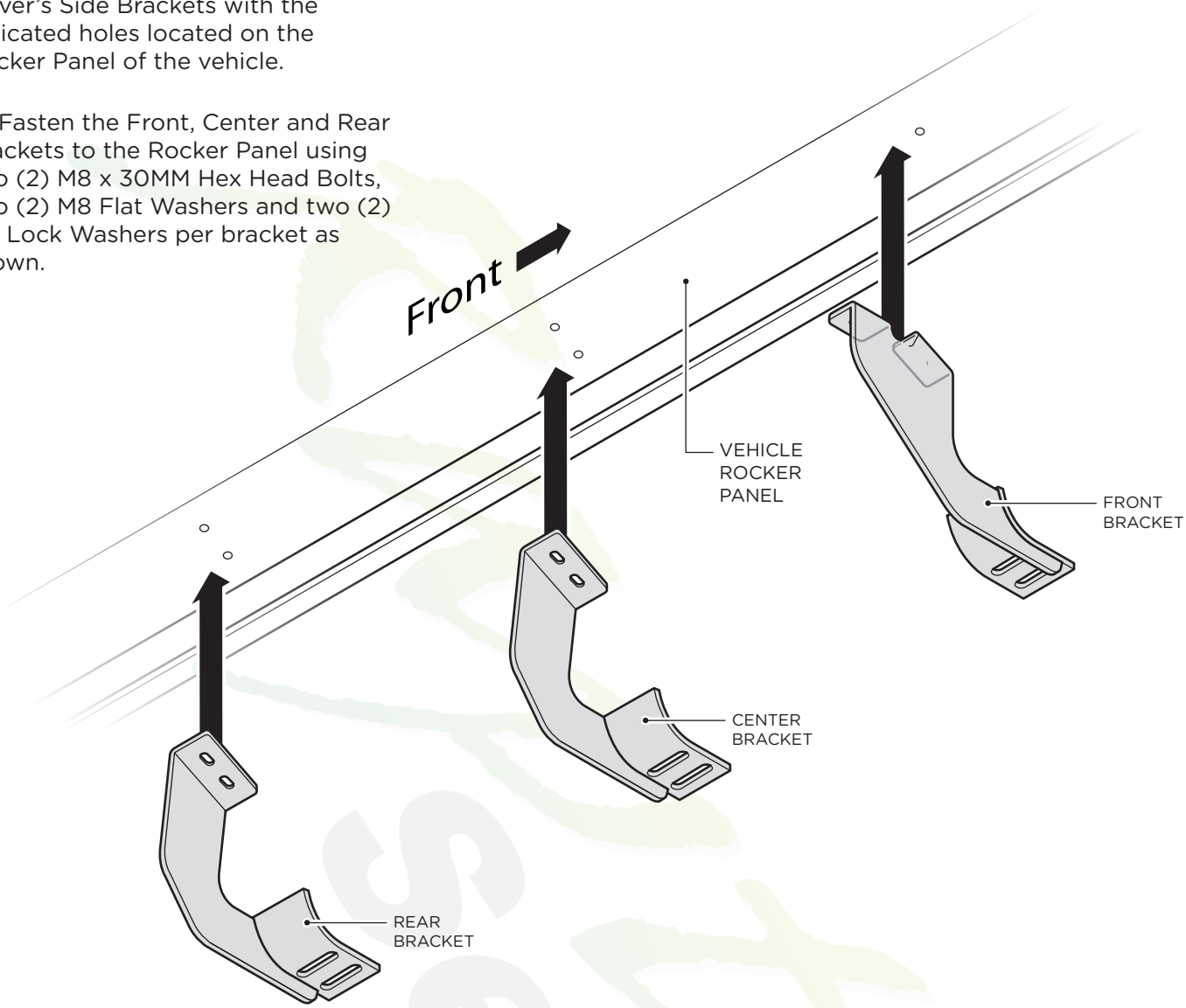

Center & Rear Bracket

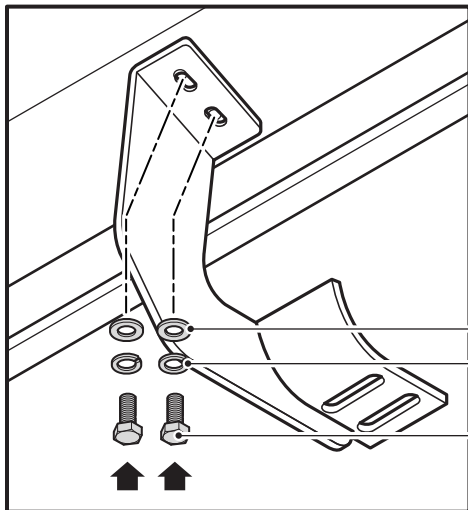

Front Bracket

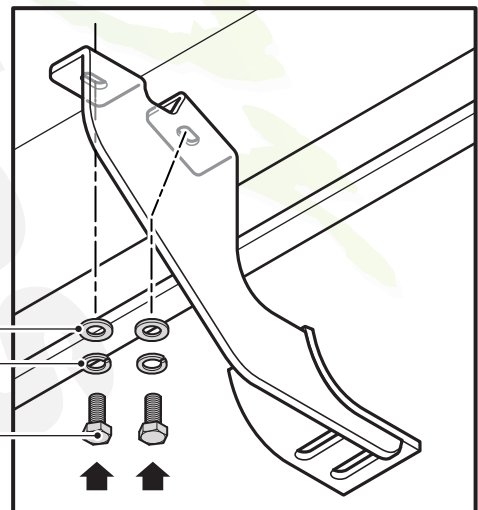

- M8 FLAT WASHER
- M8 LOCK WASHER
- M8 x 30MM HEX HEAD BOLT

6. Place the Rubber Gaskets onto the Brackets and then place the Step Bar on the brackets as well.

7. Secure the Step Bar to each bracket using two (2) M10 x 30MM Button Head Bolts, two (2) M10 Lock Washers and two (2) M10 Flat Washers per bracket.

Tighten until the split lock washer is flat against bracket and snug. **DO NOT** over tighten and strip the threaded insert in the tube.

Repeat these steps for passenger side installation. When all hardware is in place, everything must be tightened. See Page 1 for Torque Specifications.

