



1607-0195, 1607-0195B

5" OVAL BAR CURVED*Raptor*
Series**Components:**
 Driver Side Step Bar - Qty 1

 Passenger Side Step Bar - Qty 1

 Mount Bracket - Passenger Side Qty 3

 Mount Bracket - Driver Side Qty 3

 Rubber Gasket Qty 6
Hardware:
 M8 x 30MM Hex Head Bolt Qty 12

 M8 Lock Washer Qty 12

 M10 Lock Washers Qty 12

 M8 Flange Nut Qty 6

 M10 Flat Washers Qty 12

 M8 Flat Washer Qty 12

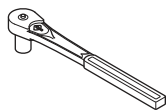
 M10 x 30 mm Button Head Bolts Qty 12
Tools Required:

RATCHET



TORQUE WRENCH



14MM SOCKET



6MM HEX BIT

Torque Specifications:

For Rocker Panel Mount Installations
M8 through M12 bolts and nuts are set to 15-20 ft lbs.

Note: When installing the brackets and bars, all hardware must be left loose until all the items are attached.

1. Remove all contents from the package and check stainless steel tubes for any damage. Also, verify that all components and hardware listed above are included before you begin installation.

2. Read installation manual and installation drawing completely. Understand all brackets and bolts before installation.

3. Begin installation on the passenger side. Align **Brackets** as shown.

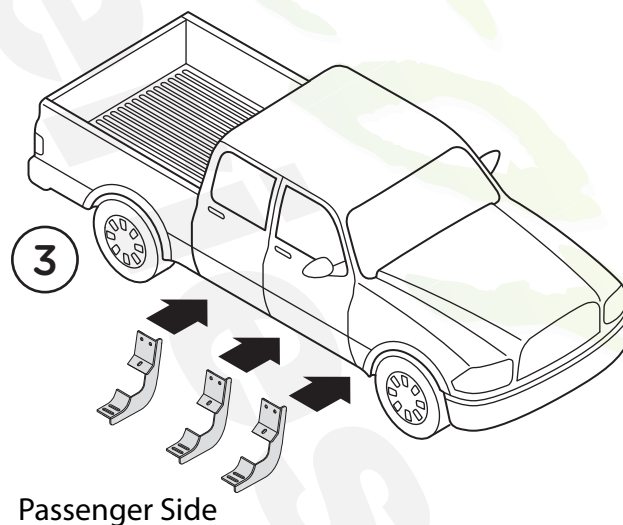

For 2004-2015 body style only

4. Align the Front, Center and Rear Passenger Side Brackets with the existing bolt and existing hole located on the Rocker Panel.

5. Secure the Front, Center and Rear Passenger Side Brackets to the existing Bolt on the Rocker Panel using one (1) M8 Flange Nut. Then fasten using one (1) M8 x 30MM Hex Head Bolt, one (1) M8 Lock Washer and one (1) M8 Flat Washer.

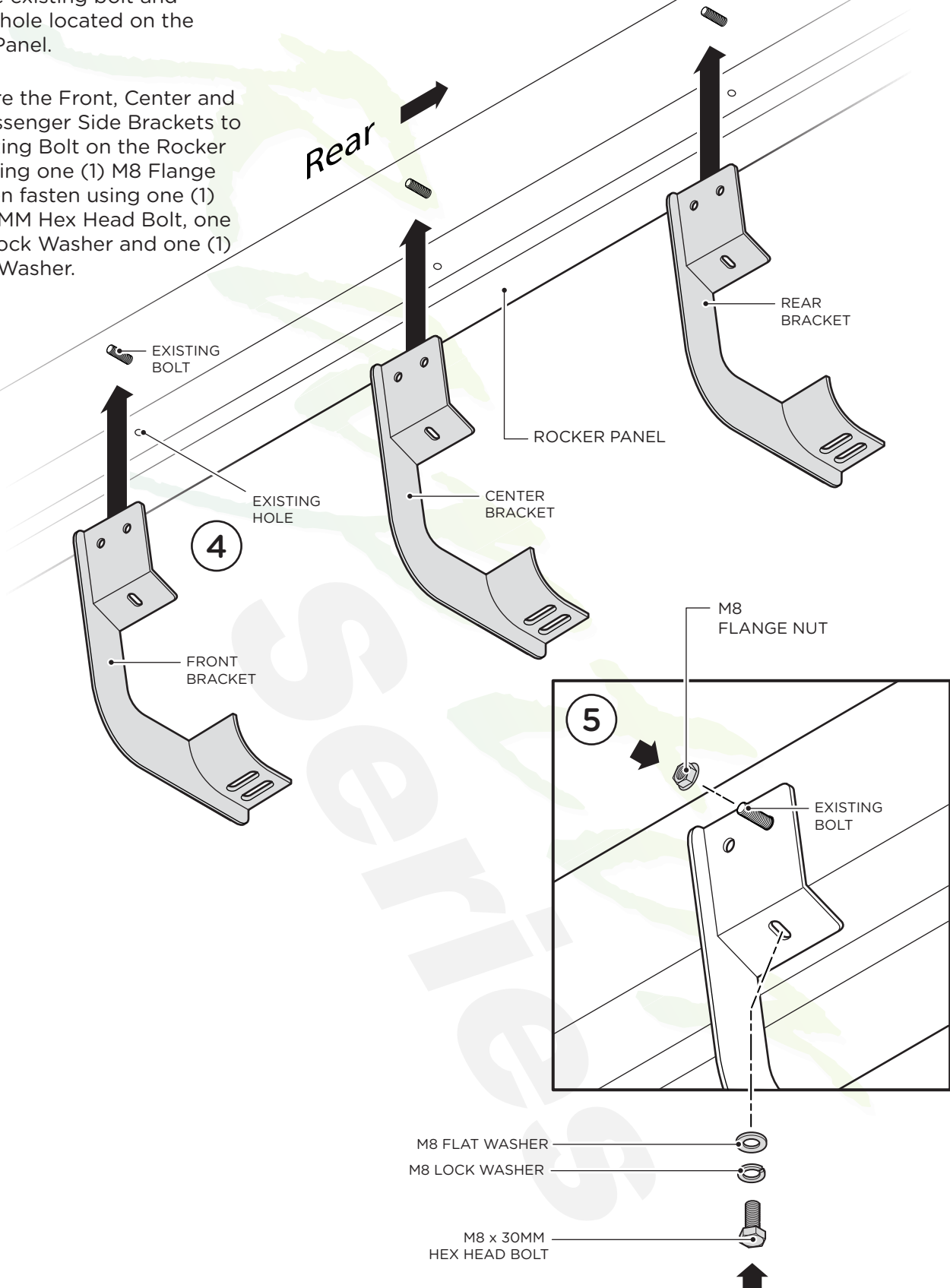

For 2016-Current body style only

6. Align the Front, Center and Rear Passenger Side Brackets with the two (2) existing holes located on the Rocker Panel (6a).

Fasten using two (2) M8 x 30MM Hex Head Bolts, two (2) M8 Lock Washers and two (2) M8 Flat Washers (6b).

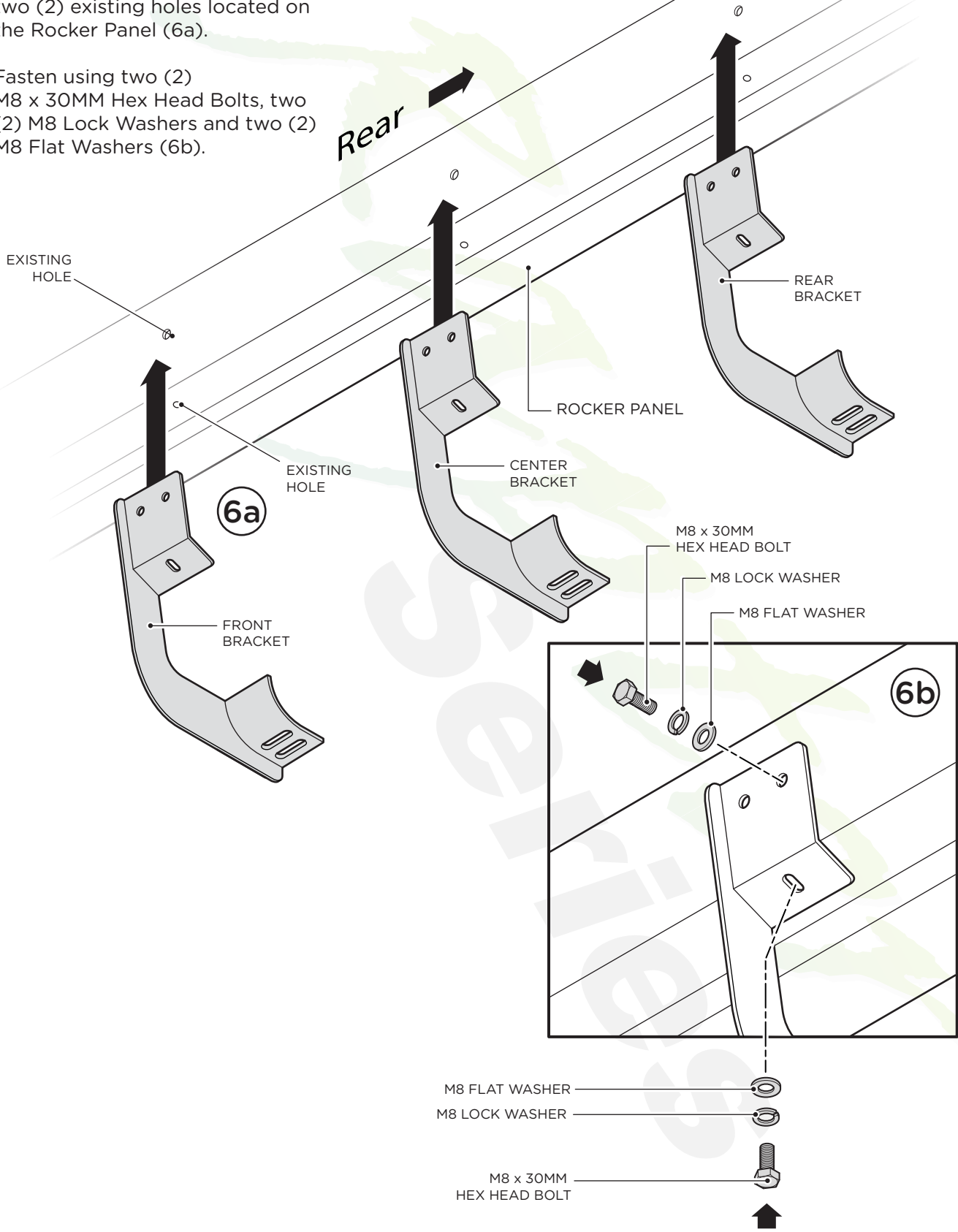

7. Place the Rubber Gaskets onto the Brackets. Then, place the Step Bar onto the Brackets. Each Step Bar is marked Driver and Passenger.

8. Secure the Step Bar to each Bracket using two (2) M10 x 30MM Button Head Bolts, two (2) M10 Lock Washers and two (2) M10 Flat Washers per bracket.

Tighten until the split lock washer is flat against bracket and snug. DO NOT over tighten and strip the threaded insert in the tube.

Repeat these steps for driver side installation. When all hardware is in place, everything must be tightened. See Page 1 for Torque Specifications.

