

INSTALLATION MANUAL

214053

Level of Difficulty

Easy

Parts List

1	Driver / left 3" oval bent side bar
1	Passenger / right 3" oval bent side bar
1	Driver / left front mounting bracket
1	Passenger / right front mounting bracket
2	Center support bracket
1	Driver / left rear mounting bracket
1	Passenger / right rear mounting bracket
4	Hex bolt, 1/2" x 2"
4	Lock washer, 1/2"
4	Larger flat washer, 1/2" x 1-1/2" OD x 1/8"
2	Combo bolts, 8-1.25mm x 25mm

Tools Required

Socket set	Ratchet
Level	--

Torque Specifications

	Metric	SAE
M6 bolt	3 ft.-lbs.	
M8 bolt	7 ft.-lbs.	
M10 bolt	16 ft.-lbs.	
M12 bolt	28 ft.-lbs.	
1/4" bolt	3 ft.-lbs.	
5/16" bolt	7 ft.-lbs.	
3/8" bolt	16 ft.-lbs.	
7/16" bolt	20 ft.-lbs.	
1/2" bolt	28 ft.-lbs.	

Use above torque setting unless otherwise noted

Product Photo



Brackets and Hardware

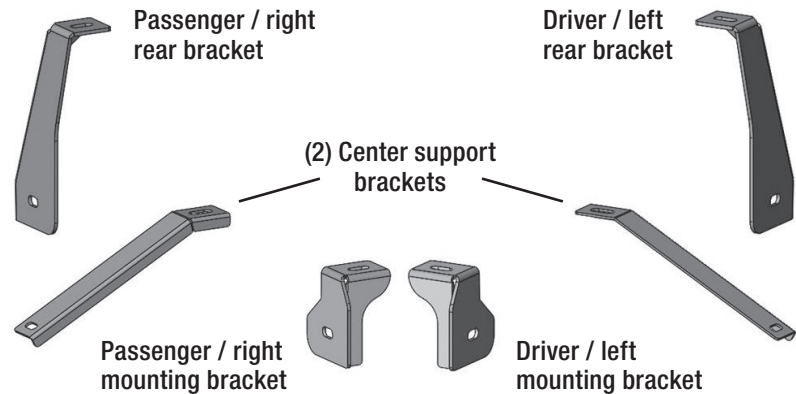

Notes and Maintenance

Before you begin installation, read all instructions thoroughly.

Proper tools will improve the quality of installation and reduce the time required.

To protect the product, wax after installing. Regular waxing is recommended to add a protective layer over the finish. Do not use any type of polish or wax that may contain abrasives that could damage the finish.

For polished, gloss and other smooth finishes, polish may be used to clear small scratches and scuffs on the finish.

Mild automotive detergent may be used to clean the product. Do not use dish detergent, abrasive cleaners, abrasive pads, wire brushes or other similar products that may damage the finish.

Refer to the last page of this manual for warranty and product registration information.

Refer to the table to the left when securing hardware during the installation process to help prevent damage to the product or vehicle.

PROCEDURE:

REMOVE CONTENTS FROM BOX. VERIFY ALL PARTS ARE PRESENT. READ INSTRUCTIONS CAREFULLY BEFORE STARTING INSTALLATION. ASSISTANCE IS RECOMMENDED.

1. Start the installation under the driver/left side of the vehicle. Locate the front body mount, **(Figure 1)**. Remove the front body bolt.
2. Select the Driver/left side Front Bracket, **(Figure 2)**. Line up the upper slot on the Bracket with the body bolt hole. Reuse the factory body bolt to attach the Bracket to the top of the body mount, **(Figure 2)**.
3. Move to the center mounting location, **(Figure 3)**. Repeat **Steps 1 & 2** to install (1) Center Support Bracket to the center body mount, **(Figure 4)**.
4. Move to the rear mounting location, **(Figure 5)**. Repeat **Steps 1 & 2** to install the Rear Mounting Bracket to the rear body mount, **(Figure 6)**.
5. Carefully unwrap and select the Driver/left Sidebar. Use the illustration above to help identify the correct Sidebar. With assistance, line up the front end of the tube with the front Bracket slot, **(Figure 7)**. Use (1) 1/2" Hex Bolt, (1) 1/2" Lock Washer and (1) 1/2" Flat Washer to attach the front end of the Sidebar tube to the Front Bracket, **(Figure 8)**. Snug but do not tighten hardware at this time.
6. Attach the Sidebar to the Center Support Bracket using (1) 8mm Combo Bolt, **(Figures 9 & 10)**. Do not tighten hardware at this time.
7. Repeat **Step 5** to attach the rear end of the Sidebar to the Rear Bracket, **(Figures 11 & 12)**.
8. Level and adjust the Sidebar as necessary and fully tighten all hardware.
9. Repeat **Steps 1—8** for Passenger/right Sidebar installation.
10. Do periodic inspections to the installation to make sure that all hardware is secure and tight.

To protect your investment, wax this product after installing. Regular waxing is recommended to add a protective layer over the finish. Do not use any type of polish or wax that may contain abrasives that could damage the finish. Mild soap may be used also to clean the Sidebar.

Driver/left Side Installation Pictured

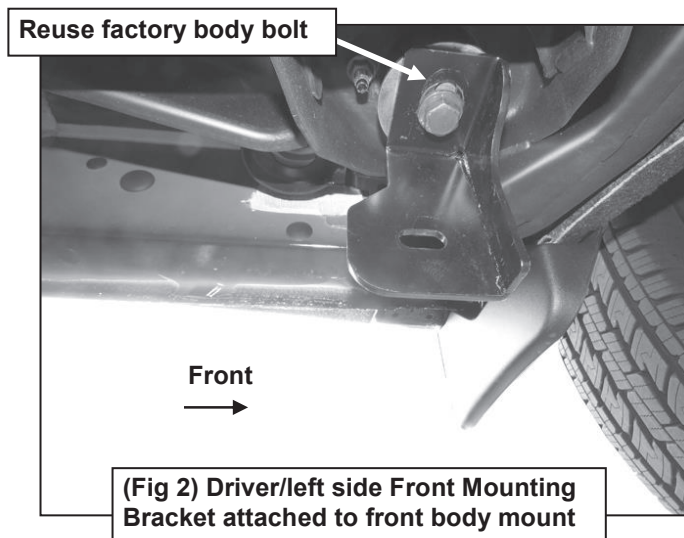
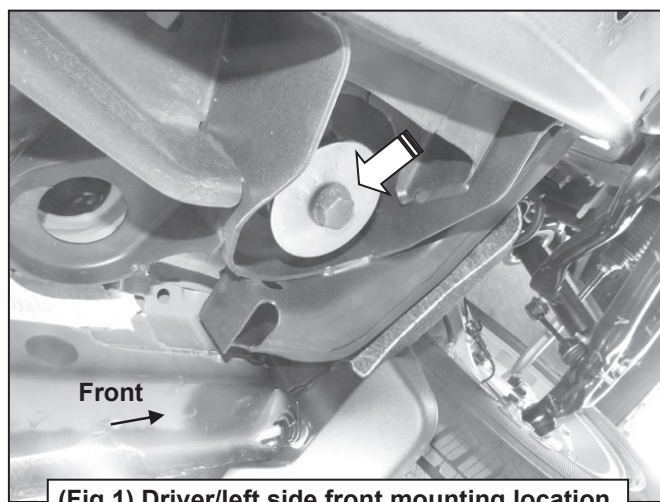

Driver/left Side Installation Pictured

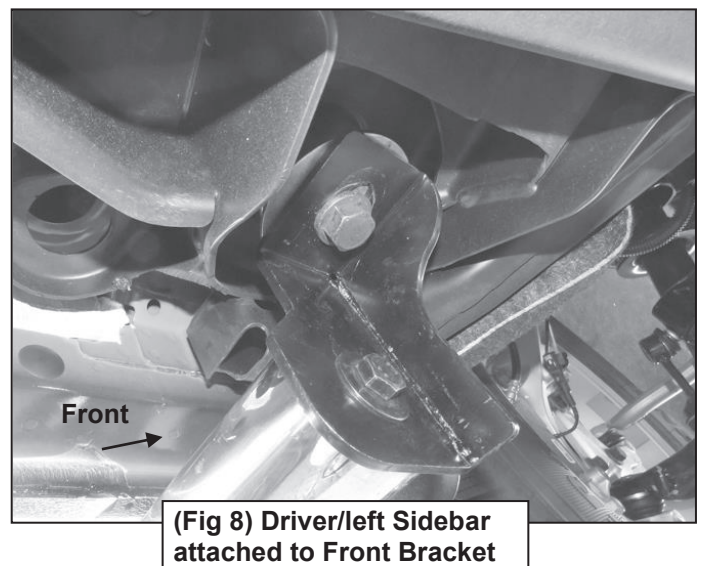
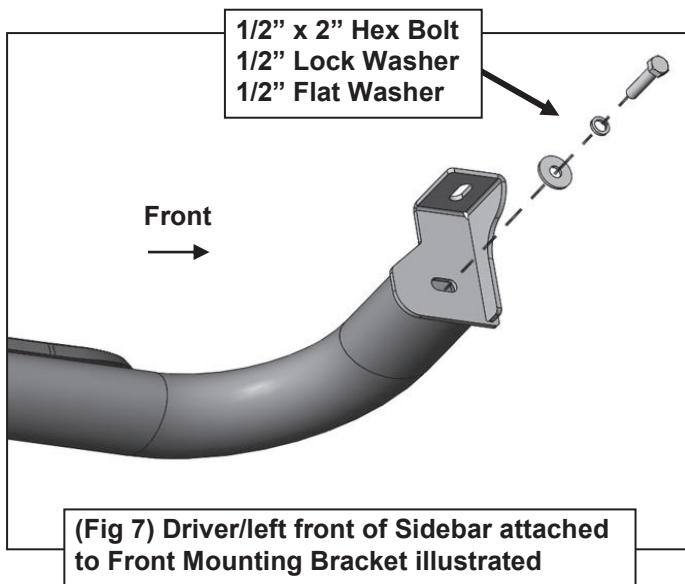
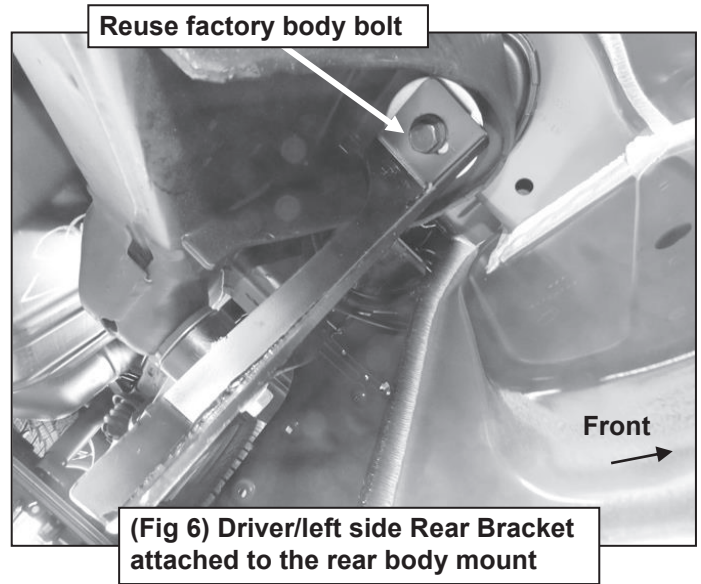
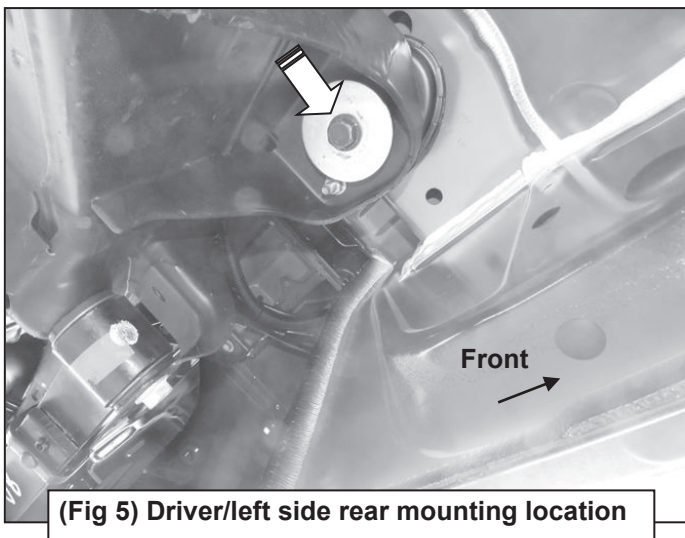
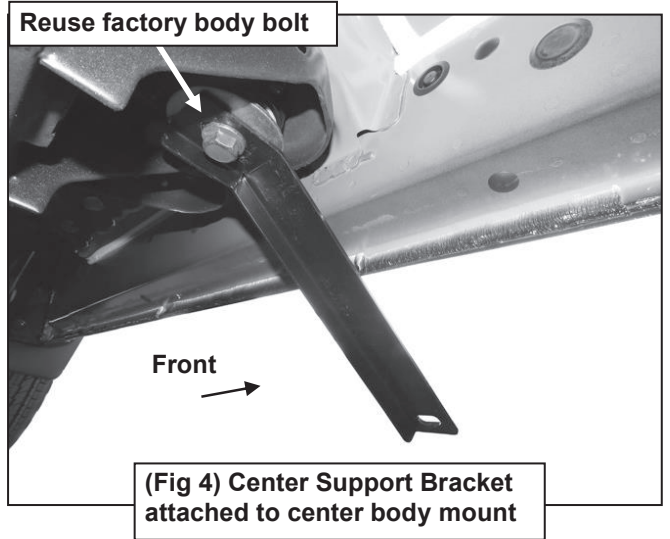
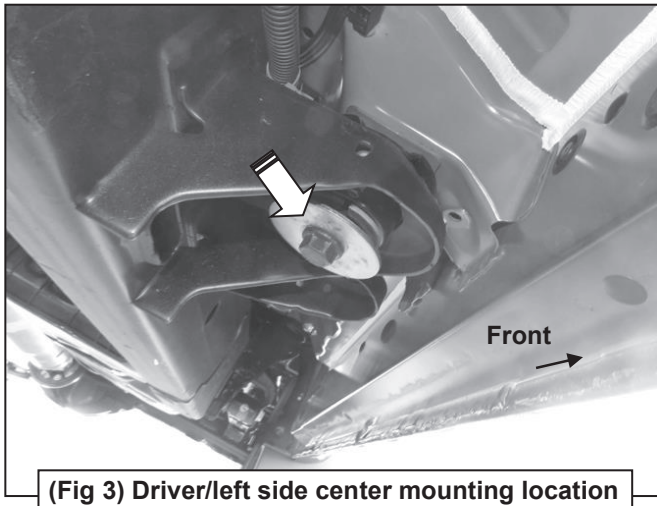

Driver/left Side Installation Pictured

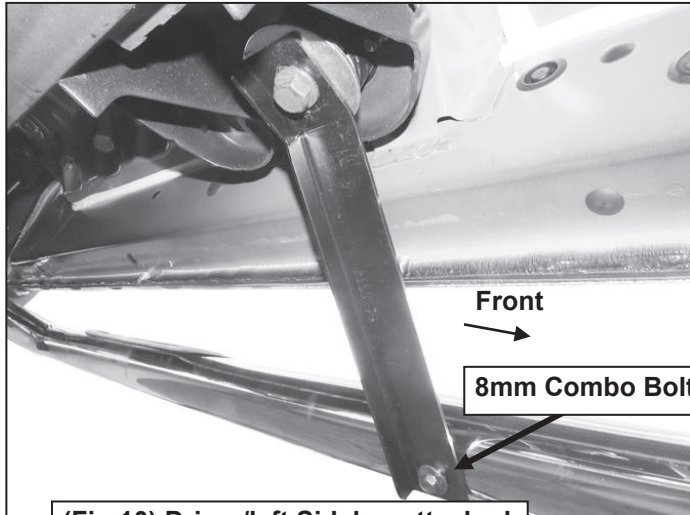

(Fig 10) Driver/left Sidebar attached to Center Support Bracket

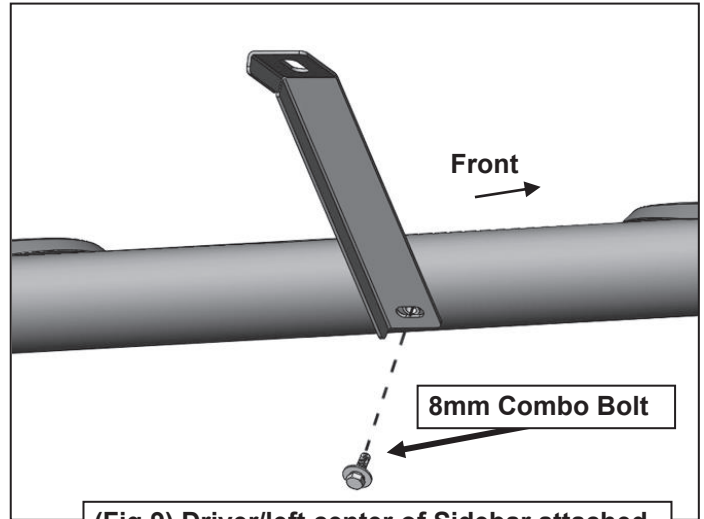

(Fig 9) Driver/left center of Sidebar attached to Center Support Bracket illustrated

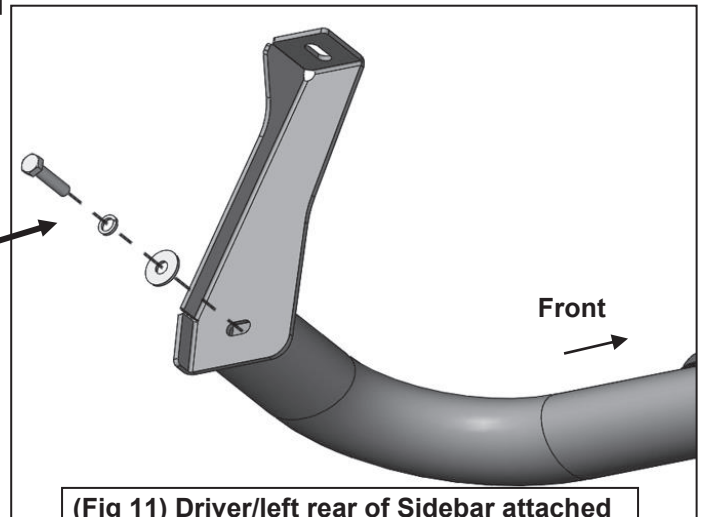

(Fig 11) Driver/left rear of Sidebar attached to the Rear Mounting Bracket illustrated

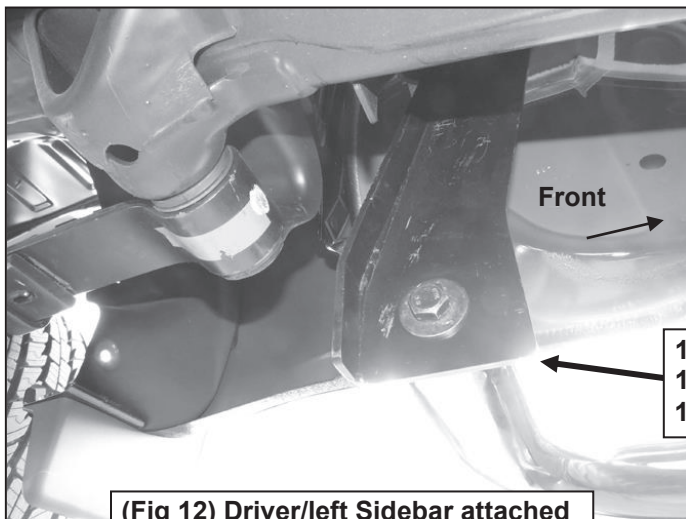

(Fig 12) Driver/left Sidebar attached to the Rear Mounting Bracket

Product Registration

CURT Group stands behind our products with industry leading warranties. You can help us continue to improve our product line and help us understand your needs by registering your purchase by visiting:

warranty.curtgroup.com/surveys

At CURT Group, customer is king. We value your feedback and we use that information to make improvements on our products. Please, take a minute and let us know how we are doing.