



Installation Instructions

BR20 Rear Bumper Replacement Part # 28178T

Toyota Tundra 2/4WD

Excludes Models with Blind Spot Monitoring & Cross Traffic Alert

Parts List

Item	Qty.	Part #	Description	Item	Qty.	Description	Torque
1	1	28178T0AC	Bumper Replacement Shell	12	6	Plastic Hole Plug	
2	1	28178T0BB-D	Driver Side Frame Bracket	13	10	10-32 x 3/4" Button Head Bolt	30 In. Lbs.
3	1	28178T0AB-D	Driver Side D-Ring Bracket	14	10	10-32 Nylon-Insert Lock Nut	
4	1	28178T0BB-P	Passenger Side Frame Bracket	15	2	License Plate Light	
5	1	28178T0AB-P	Passenger Side D-Ring Bracket	16	4	1/2" x 1 1/2" Carriage Bolt	65 Ft. Lbs.
6	1	28178T5GB	Sensor Plate (driver inner)	17	4	1/2" Flat Washer	
7	1	28178T5GB	Sensor Plate (passenger inner)	18	4	1/2" Lock Washer	
8	1	28178T5FB	Sensor Plate (driver outer)	19	4	1/2" Hex Nut	
9	1	28178T5FB	Sensor Plate (passenger outer)	20	2	M14-1.5 x 50mm Hex Bolt	88 Ft. Lbs.
10	4	28178T3GA	Round Spacer	21	2	M14 Flat Washer	
11	2	28173T5AB	Blank Plate	22	2	M14 Lock Washer	

ILLUSTRATION #1

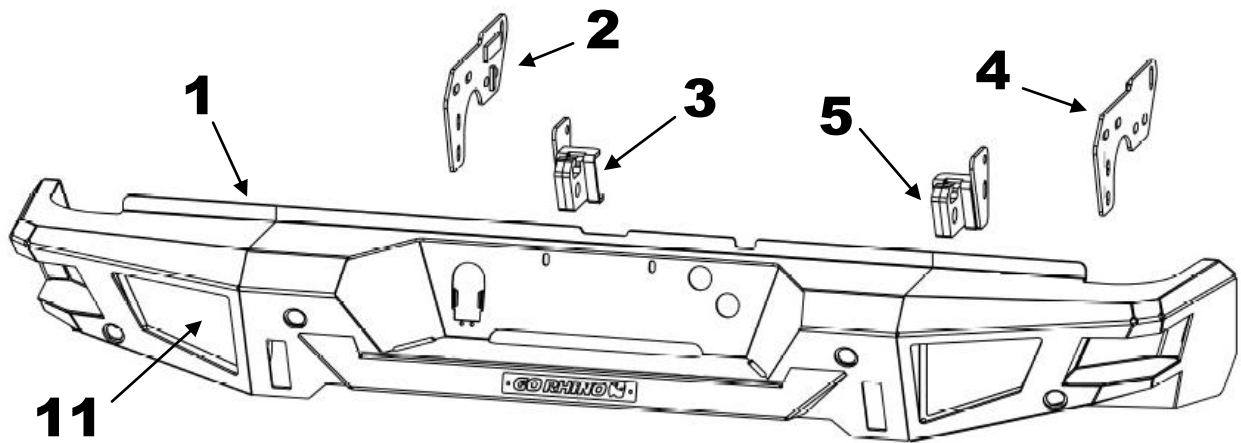

Tool Required:

12mm, 17mm, 19mm, 22mm, 3/8" & 3/4" Sockets
10mm, 12mm, 17mm, 19mm, 22mm, 3/8" & 3/4" Wrenches
Phillips Head & Slotted Blade Screw Driver
1/8" Hex Key
Ratchet, Ratchet Extensions & Swivel Joint Adapter
12V Circuit Tester
Rotary tool & Bit

Approximate installation time: 2 Hrs.

IMPORTANT INSTALLATION NOTES AND SUGGESTIONS

Read the installation instructions completely and verify that all of the parts listed are accounted for. If you have defective, missing, or damaged parts or need assistance, please contact Go Rhino Products for fast, friendly customer service at: (888) 427-4466 or email: sales@gorhino.com

Verify that the tailgate does not come in contact with the bumper replacement when opening and in the lowered position, before final tightening all nuts and bolts. If necessary, loosen the nuts and bolts to adjust the bumper replacement.

If the vehicle is equipped with a factory receiver hitch, (2) of the attachment holes on each side of the receiver hitch will require modification.

If you are replacing a bumper with rear Park Assist, the sensor detection zone will be altered with use of this bumper replacement.

To maintain and care for this product keep it clean and do not use abrasive cleaners or polish waxes. Texture Painted Finish: Mild liquid detergent may be used. Polished Stainless & Semi-Gloss Painted Finishes: We recommend using only non-abrasive automotive wax such as pure carnauba to avoid scratches and rust.

Factory Bumper Removal

Step-1 Disconnect the vehicle battery or batteries.

Step-2 Disconnect the bumper wiring harness from the vehicle wiring harness, (Photo 1).

Step-3 Disconnect the wiring harness from the trailer plug (Photo 2) and remove the trailer plug from the factory bumper.

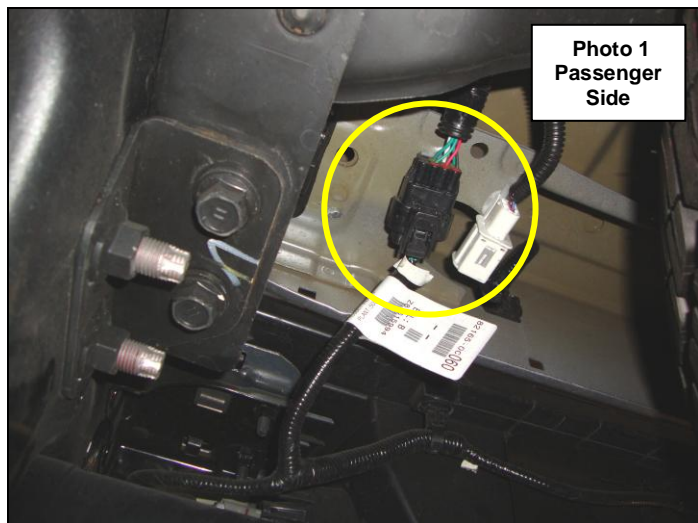

Step-4 If your vehicle is not equipped with a factory receiver hitch, remove the (4) bolts on each side of the vehicle securing the factory bumper brackets to the frame (Photo 3) and remove the bumper from the vehicle then proceed to the bumper replacement installation steps.

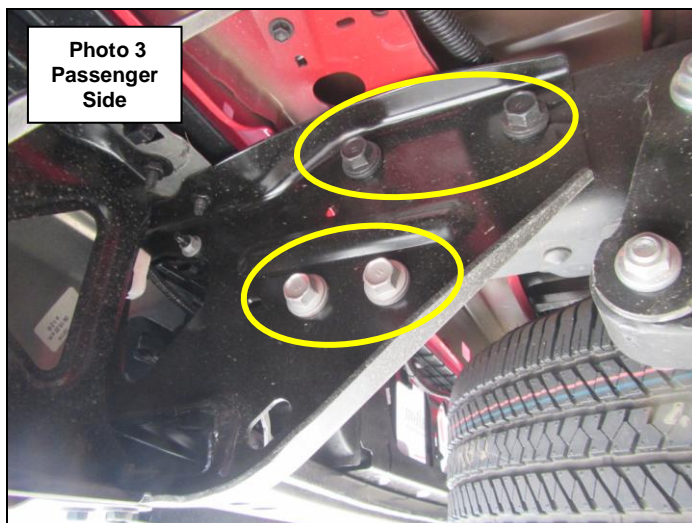

Factory Bumper Removal

Step-4.1 If your vehicle is equipped with a factory receiver hitch, remove license plate from the bumper, and the Phillips head screw securing bumper cover center section to the receiver hitch, (Photo 4).

Step-5 Remove the plastic rivets (1) per side securing the bottom of the bumper cover center section, (Photo 5).

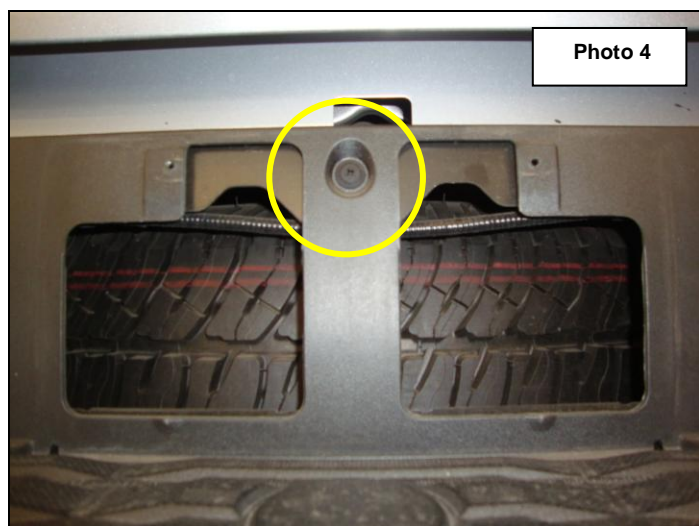

Step-6 Remove the bumper cover center section and end caps from the bumper by pulling up from the outside edge, (Photo 6). To ease removal, the clips securing the center section and end caps can be popped loose from the underside of the bumper ends.

Step-7 Remove the (4) bolts from the top and (2) bolts from the bottom securing each bumper end to the receiver hitch, (Photo 7 & 8). Remove the bumper ends from the receiver hitch.

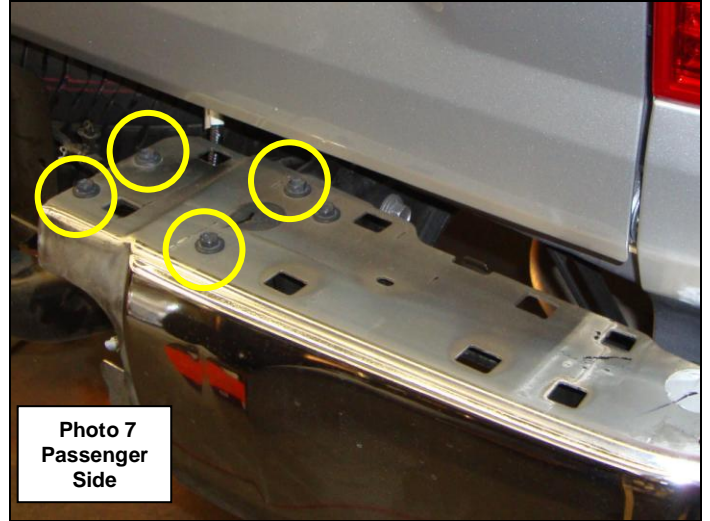
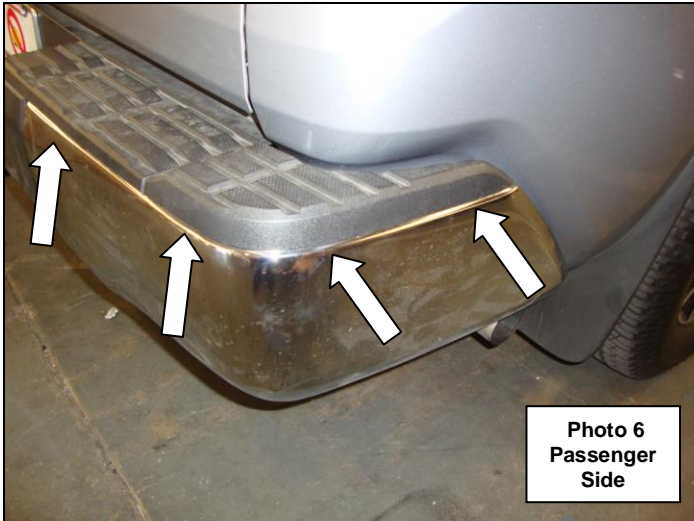

Factory Bumper Removal

Step-8 Remove the (2) nuts and bumper end brackets from the receiver hitch, (Photo 9).

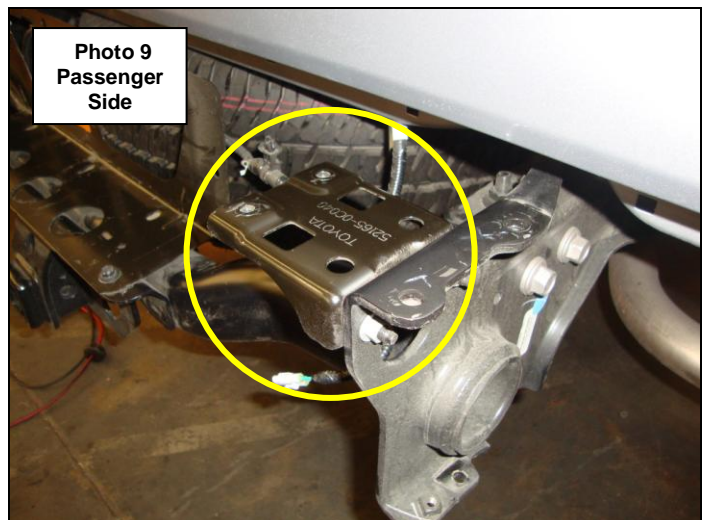
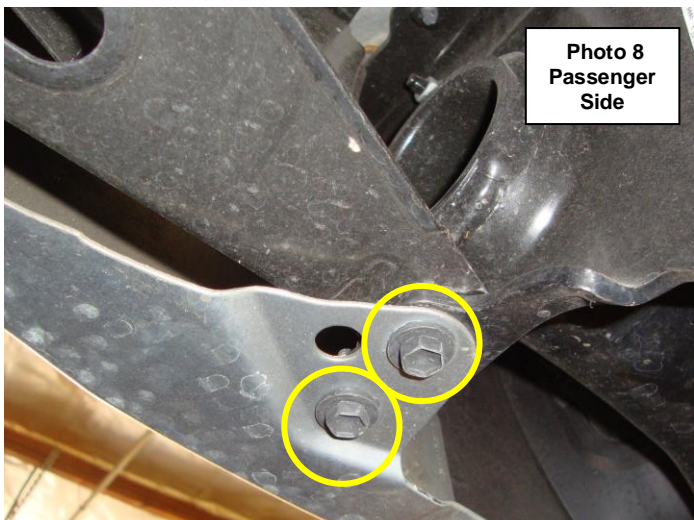

Bumper Replacement Installation

Step-1 If the vehicle is equipped with rear parking assist sonar, remove the retaining clip securing each sensor to the factory bumper, push the sensor out through the hole in the factory bumper, then lift the tab on the plug connector to release the sensor. Note: Do not push on the front of the sensor as this may damage the sensor.

Note: The (4) sensors have to be positioned in the rear bumper replacement in the same location (inner and outer), (driver and passenger) as removed from the factory bumper

Step-2 Install the sensors in the sensor plates (inner sensor and plate shown) using the factory retaining clips, (Photo 1 & 2). Note: The 4 notches in the sensor plates designate the top.

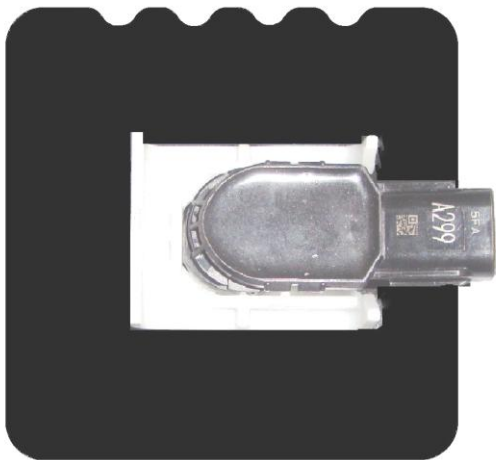

Photo 1

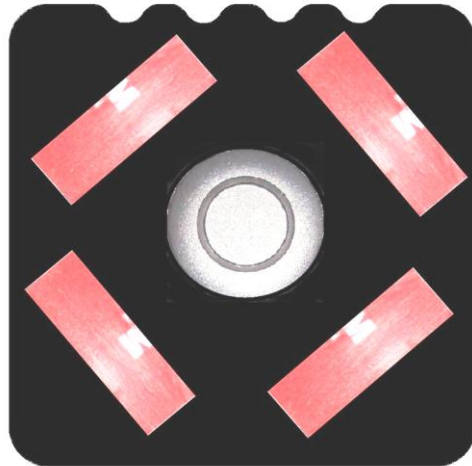

Photo 2

Step-3 Prepare the inside surface of the bumper shell where the bezel plates will be mounted with Isopropyl alcohol. A clean, dry surface is required in order for tape to stick properly.

Step-4 Peel the backing off from the double-sided tape to uncover the adhesive. From inside the bumper shell position each bezel, sensor and bezel plate assembly, making sure the sensor bezel is centered in the hole provided in the bumper shell, (Photo 3 & 4).

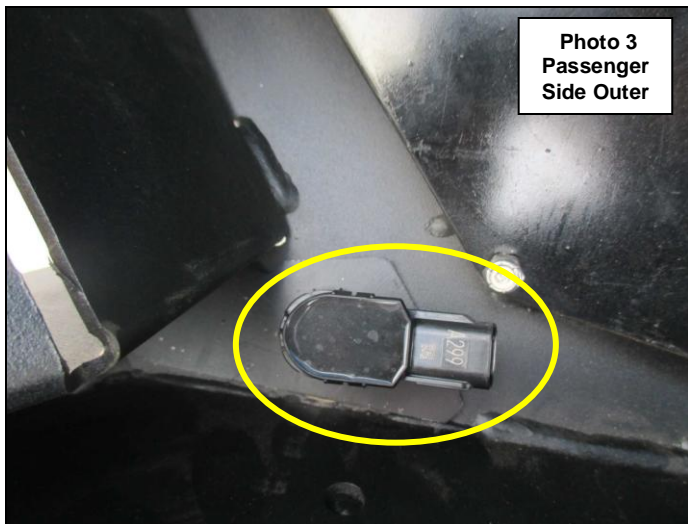

Photo 3
Passenger
Side Outer

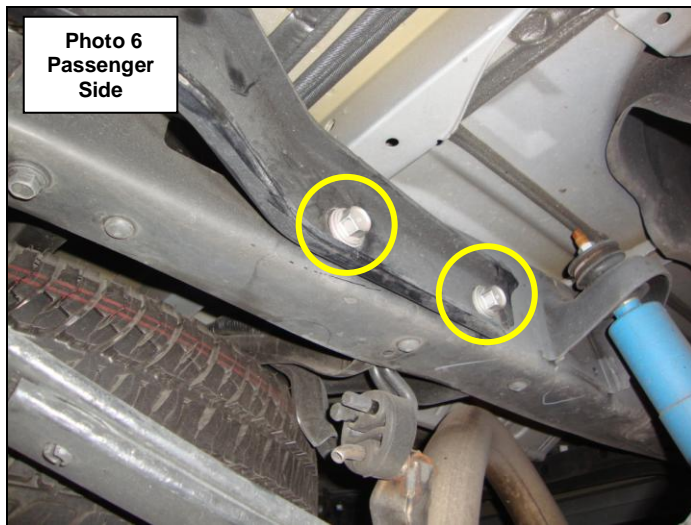
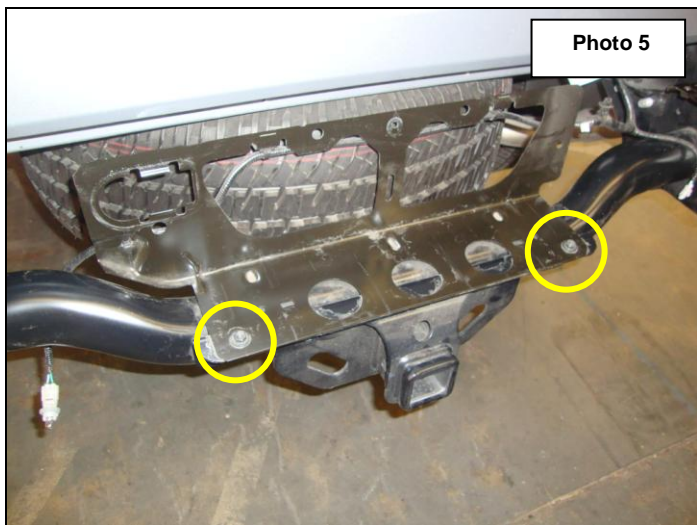

Photo 4
Passenger
Side Outer

Step-5 Stick the assembly in place and apply firm pressure for about 30 seconds. The tape needs to bond with the mounting surface, and it needs pressure to do this. The bezel mounting plate will seem like it is stuck on, but continue pressing for at least 30 seconds. Note: At room temperature approximately 50% of ultimate bond strength will be achieved after 20 minutes, 90% after 24 hours, and 100% after 72 hours.

Step-6 Remove the (2) bolts securing the bumper cover / trailer plug bracket to the center of the receiver hitch, (Photo 5).

Step-7 Locate the (2) bolts on each side of the vehicle securing the front of the factory receiver hitch to the frame, (Photo 6). Remove the front bolt and only loosen the rear. **Note:** Do not remove the rear bolts, as the receiver hitch needs to pivot on these bolts to make the modification.



Step-8 With assistance support the receiver hitch and remove the (4) bolts on each side of the vehicle securing the rear of the receiver hitch to the side of the frame, (Photo 7). Let the receiver hitch pivot on the front bolts and hang down.

Step-9 On each side of the vehicle, remove the (2) bolts securing the frame extension brackets to the bottom of the frame, (Photo 8).

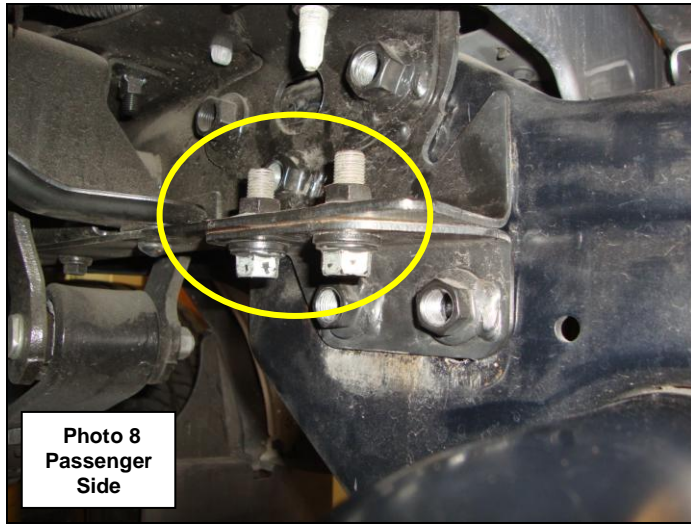
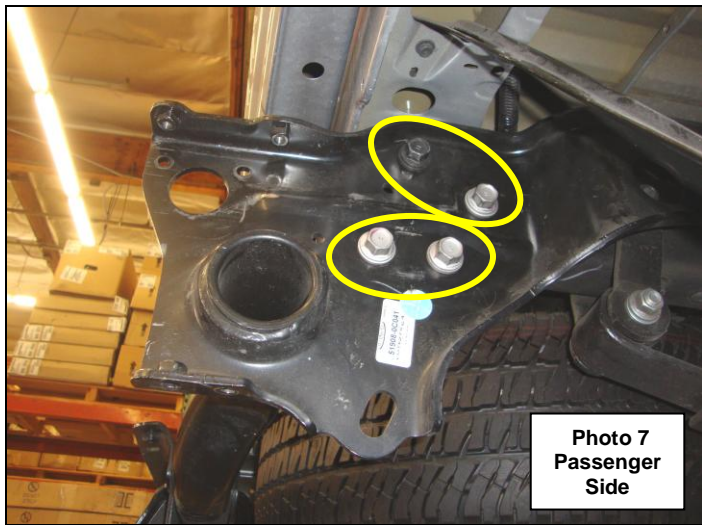

Step-10 Position (2) of the round spacers between the extension bracket and frame, align the holes and reinstall the (2) factory bolts, (Photo 9 & 10). Snug but do not tighten the bolts. Repeat for the driver side.

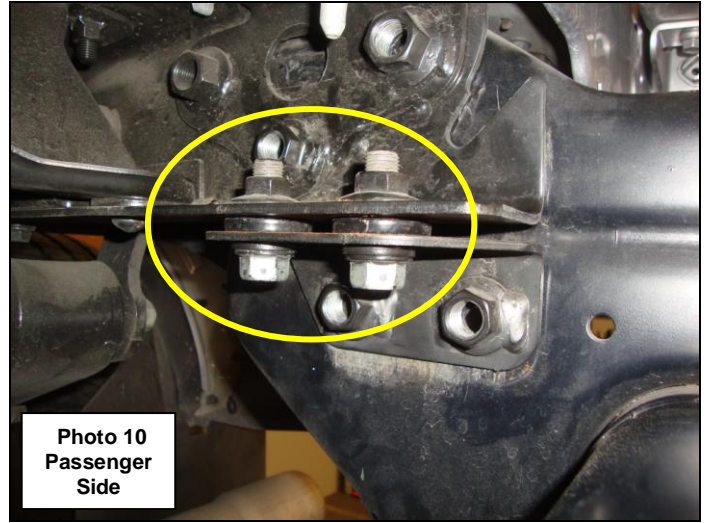
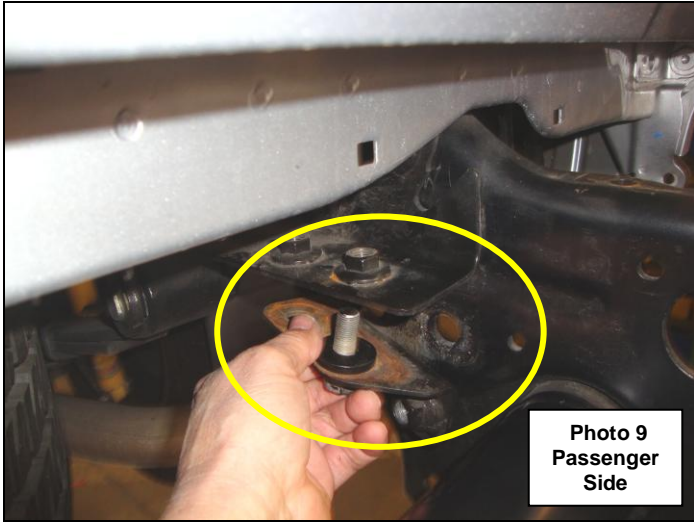

Step-11 With assistance lift and reattach the receiver hitch to each frame extension bracket using (2) of the factory bolts, (Photo 11). Note: Only start a few threads on each bolt, do not tighten.

Step-12 The (2) upper attachment holes in each side of the receiver hitch will require modification to align with the nuts welded in the frame, (Photo 12). On each side of the receiver hitch, mark the area above the holes to be elongated. Note: The (2) holes need to be elongated upward 3/8" and on a slight angle so the factory bolts can be reinstated with the receiver hitch in the new position.

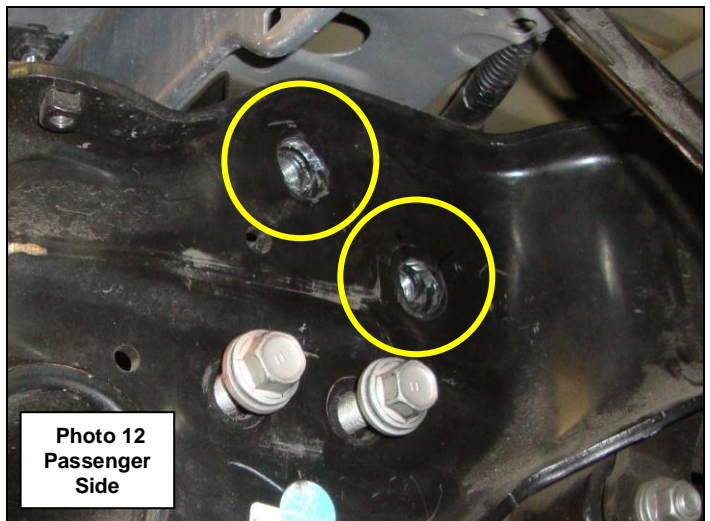
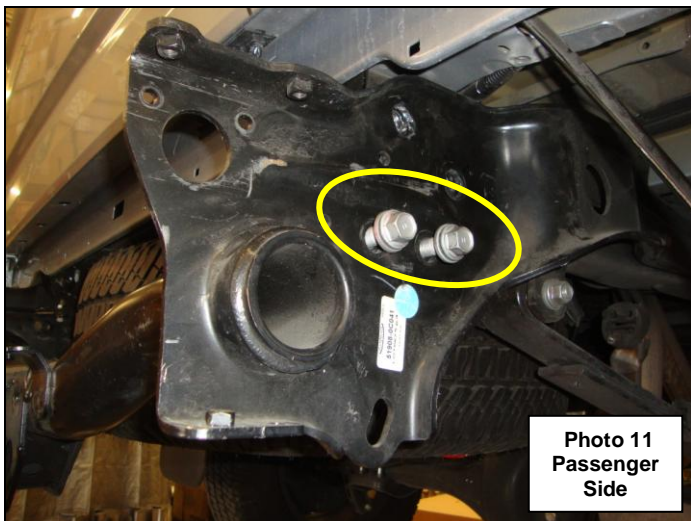

Step-13 Remove the factory bolts and let the receiver hitch pivot and hang down. Using a rotary tool and bit to elongate the holes in each side of the receiver hitch, (Photo 13).

Step-14 With assistance lift the receiver hitch into position and attach the passenger side frame bracket and receiver hitch to the frame using the M14 bolt and washers supplied and to the frame extension bracket using (2) of the factory bolts, (Photo 14). Leave the bolts loose for final adjustment. Repeat for the driver side bracket then reinstall the remaining factory bolts to secure the receiver hitch to the frame.

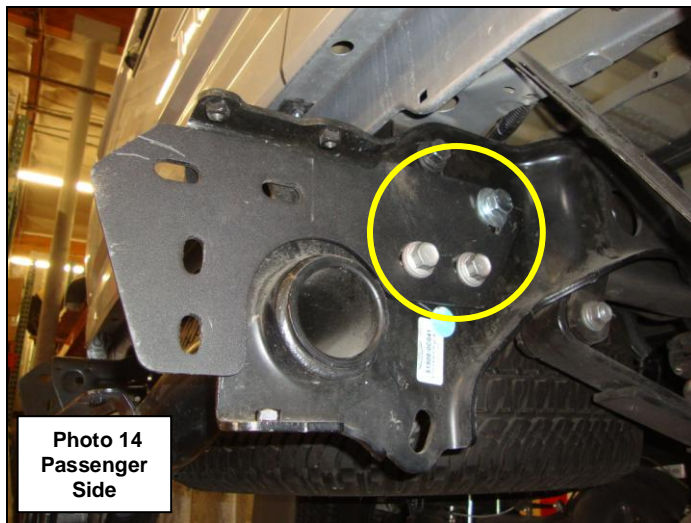
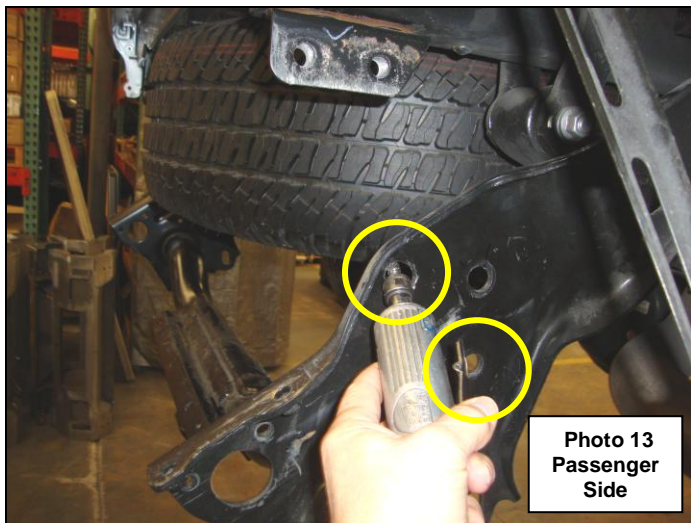

Step-14.1 If your vehicle is not equipped with a factory receiver hitch, attach the passenger side frame bracket to the frame using the M14 bolt and washers supplied and to the frame extension bracket using (2) of the factory bolts. Leave the bolts loose for final adjustment. Repeat for the driver side bracket.

Step-15 With assistance, lift the bumper replacement up to the vehicle. From behind the bumper, position the passenger side D-Ring bracket on the inside of the bumper bracket with the D-Ring extending out through the opening in the bumper. Align the holes and attach the D-Ring bracket and bumper bracket to the frame bracket using (2) 1/2" x 1 1/2" carriage bolts, (2) 1/2" flat washers, (2) 1/2" lock washers and (2) 1/2" hex nuts, (Photo 15 & 16). Leave the nuts and bolts loose for final adjustment. Repeat for the driver side.

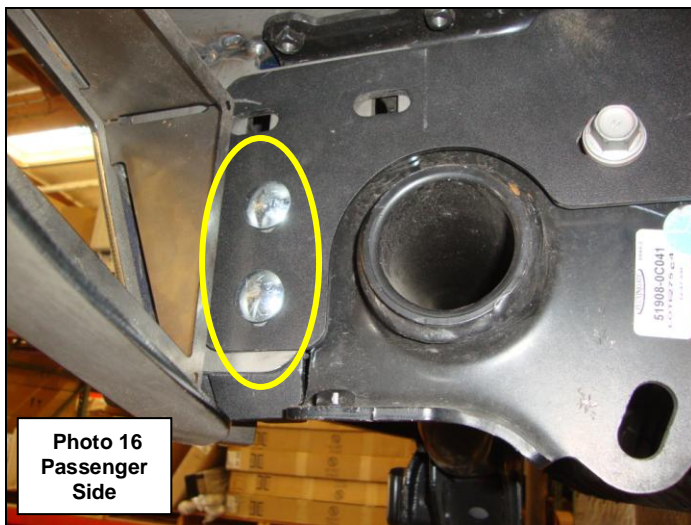

Step-16 Align the replacement bumper with the vehicle, verify that the tailgate clears when lowered, and tighten all factory and supplied nuts and bolts.

Step-17 Remove the trailer plug from the factory bumper and install it in the bumper shell, and reconnect the wiring harness, (Photo 18).



Step-18 Reconnect the factory bumper wiring harness to the sensors and to the vehicle wiring harness.

Step-19 Install the license plate using the supplied LED lights and fasteners to the bumper shell. Use a circuit tester to find the hot and ground from the factory license plate light wiring, and then splice the wires from the supplied lights.

Step-20 Install the supplied plastic plugs to fill the unused spare tire winch access tube holes in the bumper shell.

Step-21 Install the supplied blank plates or optional light mounts to the rear bumper replacement using (4) 10-32 x $\frac{3}{4}$ " button head bolts and (4) 10-32 lock nuts.

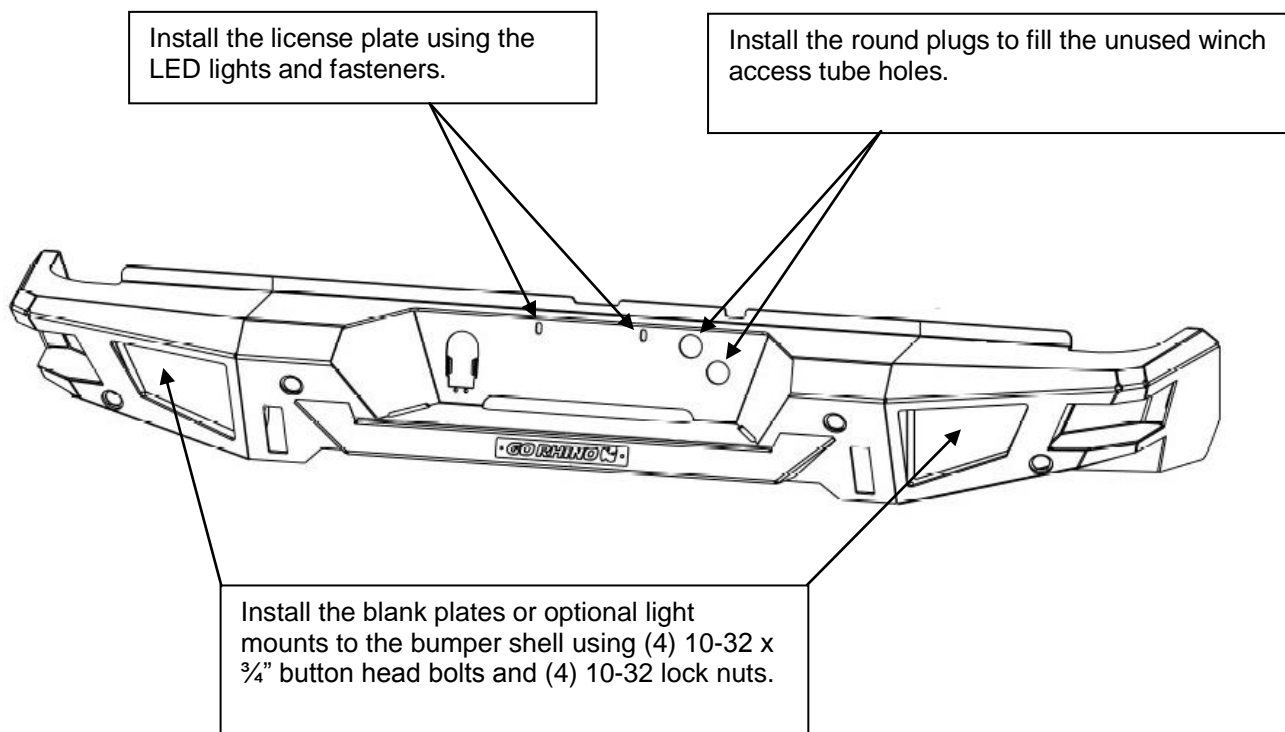

Step-22 Remember to check and retighten all factory and supplied nuts and bolts periodically.