

EGR

INSTALLATION INSTRUCTIONS

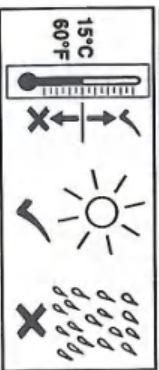

Tools Required

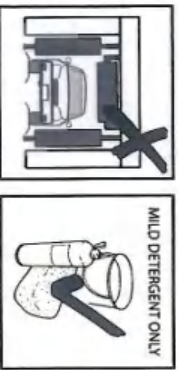
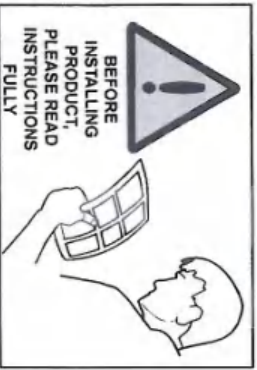

1

Read instructions thoroughly before commencing fitment.

Wash and dry the vehicle.

Thoroughly clean the top of the hood and surrounding areas.

Open the hood and clean the underside and surrounding areas.

Wipe away any residue and allow to completely dry.

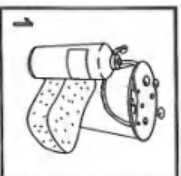
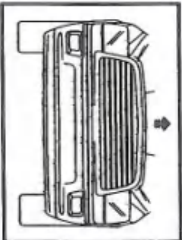
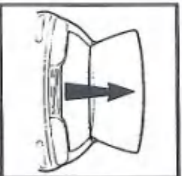

EGR

INSTALLATION INSTRUCTIONS

2

Trial fit the Hood Deflector (A) centrally onto the hood, align the front edge of the Hood Deflector with the hood lip.

Note & mark with a non-permanent marker

- where the two outer holes align with the lip of the hood.
- where the two inner slots align with the lip of the hood.
- where the central hole aligns with the lip of the hood.

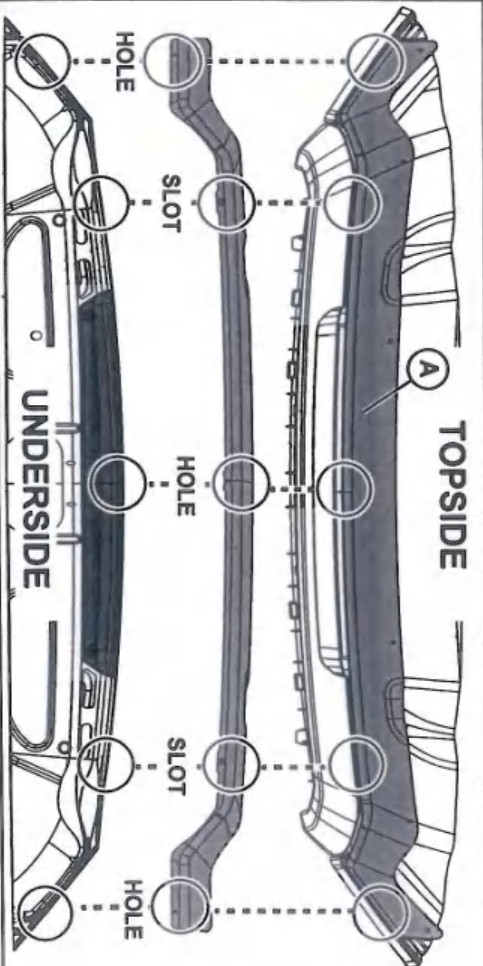

3

Clean the previously marked hole and slot positions with the alcohol wipe (L) provided. Allow to dry.

At these five locations adhere the abrasion resistant tapes (E) over the hood lip.

At the centre clip location ensure the seal is under the centre seal.

Apply the tape so that approximately two thirds of each strip is on the top surface of the hood & one third folds over the underside.

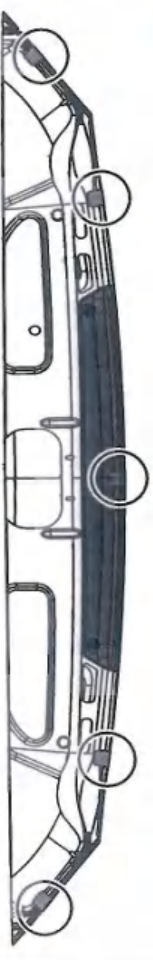

4

Peel back the adhesive backing from the foam pads (G) and adhere to each clip (C).

Peel back the adhesive backing from the foam pads (H) and adhere to each clip (B).



EGR

INSTALLATION INSTRUCTIONS

5

Remove the white backing from the four small protective strips (D) and adhere them over the abrasive resistant tapes at the four outer clip locations underneath the hood.
Visually confirm with clip (B) that the screw hole on the outer clip aligns with the small protective strip.

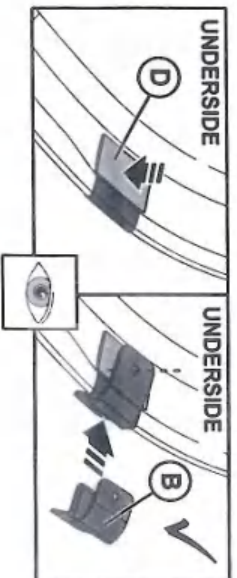
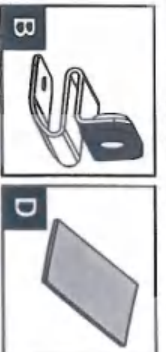

6

Slide the push-on clip (C) over the abrasive resistant tape on the hood lip at correct position.

IMPORTANT: Ensure that the clip is positioned over abrasive resistant tape and do not come in contact with any of the hood's paint work. Failure to do this may result in permanent paint damage.
Ensure clip (C) sits underneath the rubber seal.

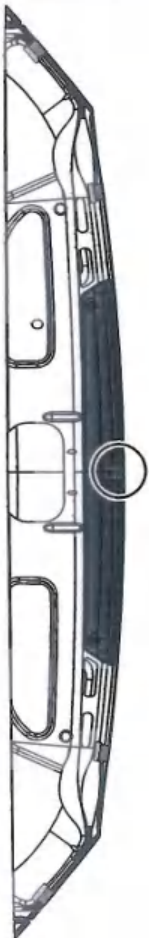

7

Engage a few threads of the self-tapping screw (K) into the clip (B) and slide the clip onto the hood lip. Align the clip over the abrasive resistant tape and small protective strip and finger tighten the screw.

IMPORTANT: Ensure that the clips are positioned over abrasive resistant tape and do not come in contact with any of the hood's paint work. Failure to do this may result in permanent paint damage.

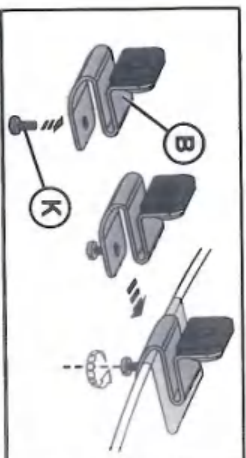
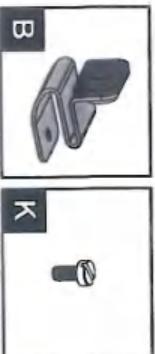

EGR

INSTALLATION INSTRUCTIONS

8

Re-fit the Hood Deflector, ensure it is central and fasten with the screws (J) and washers (I) provided.

Tighten the bottom self-tapping screws (K) on the outer clips.

IMPORTANT: Ensure that the clips are positioned over abrasive resistant tape and do not come in contact with any of the hood's paint work.

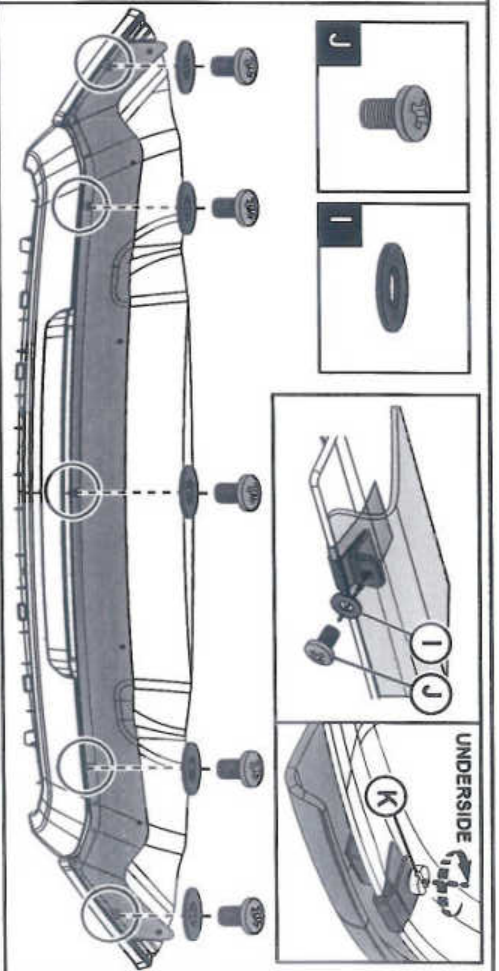

9

At the six bumpson positions which are indicated by the bumpson location stickers on the Hood Deflector, clean the top of the hood with the alcohol wipe(L), allow to dry and adhere a bumpson (F) directly to the hood underneath each sticker.

Peel off and discard the bumpson location stickers when complete.

