

INSTALLATION INSTRUCTIONS AND PARTS LIST
MODEL 477078, 477088, 477098 REGAL 7 OVAL STEPS (BOARDS ONLY)
277078, 277088 REGAL 7 OVAL STEPS BLACK



1. Read instructions completely and check to make sure that all required parts (listed on the service parts list) are on hand before starting the installation.
2. Follow the instructions included with the specific bracket package that you are using to mount the brackets to your vehicle.
3. The step is pre-assembled from the factory. The serial number label is located on the front inside drivers side step assembly.
4. Attaching the step to the mounting bracket:
 - 4.1 Set the step on the mounting brackets, and slide each support mounting plate (item #9) inside the oval step and above each bracket.
 - 4.2 Using the supplied 5/16-18 x 1" black stainless steel hex bolt, washer, and serrated flange nut (items # 10,11&12) attach the step assembly, support mounting plate and mounting bracket.
 - 4.3 Set the step plate in the correct position and tighten all fasteners.
Torque all 5/16" fasteners to 19 LB FT.

SERVICE PARTS LIST

ITEM	PART NO.	QTY	DESCRIPTION
1&2	552059	2	REGAL 7 OVAL STEP, LH,RH,76",477078
1&2	552060	2	REGAL 7 OVAL STEP, LH,RH,86",477088
1	552061	1	REGAL 7 OVAL STEP, LH,96",477098
2	552062	1	REGAL 7 OVAL STEP, RH,96",477098
1&2	552089	2	REGAL 7 OVAL STEP,LH,RH, 277088,BLK
1&2	552090	2	REGAL 7 OVAL STEP,LH,RH, 277078,BLK
3	109233	2	END CAP LH REAR, RH FRONT,BLK PLASTIC
4	109232	2	END CAP RH REAR, LH FRONT,BLK PLASTIC
5	107863	8	BOLT-CARRAIGE, 10-24 X 0.50,SST, BLACK
6	108909	4	STEP PAD, 25" X 6.5", PLASTIC, BLACK
7	108908	24	BOLT-CARRAIGE, 10-24 X 1.0,SST, BLACK
8	107864	24	NUT-NYLOCK, 10-24, SST
9	552052	8	SUPPORT MTG PLT, 11 GA, GALV
10	106997	16	SCREW-HEX HD, 5/16-18X1.0,SST,BLACK
11	106998	16	WSHR-FLAT, 5/16, SST, BLACK
12	102680	16	NUT-SER FLG, 5/16-18, SST



(A LIVERNE Company)

1200 E. Birch St.

Brandon, SD 57005

REV B 30DEC15

REV A 31JUL12

552065 SHEET 1 OF 2 24FEB12

SERVICE PARTS LIST

MODEL NO. - 477078
 - 477088
 - 477098

LH 1
 RH 2

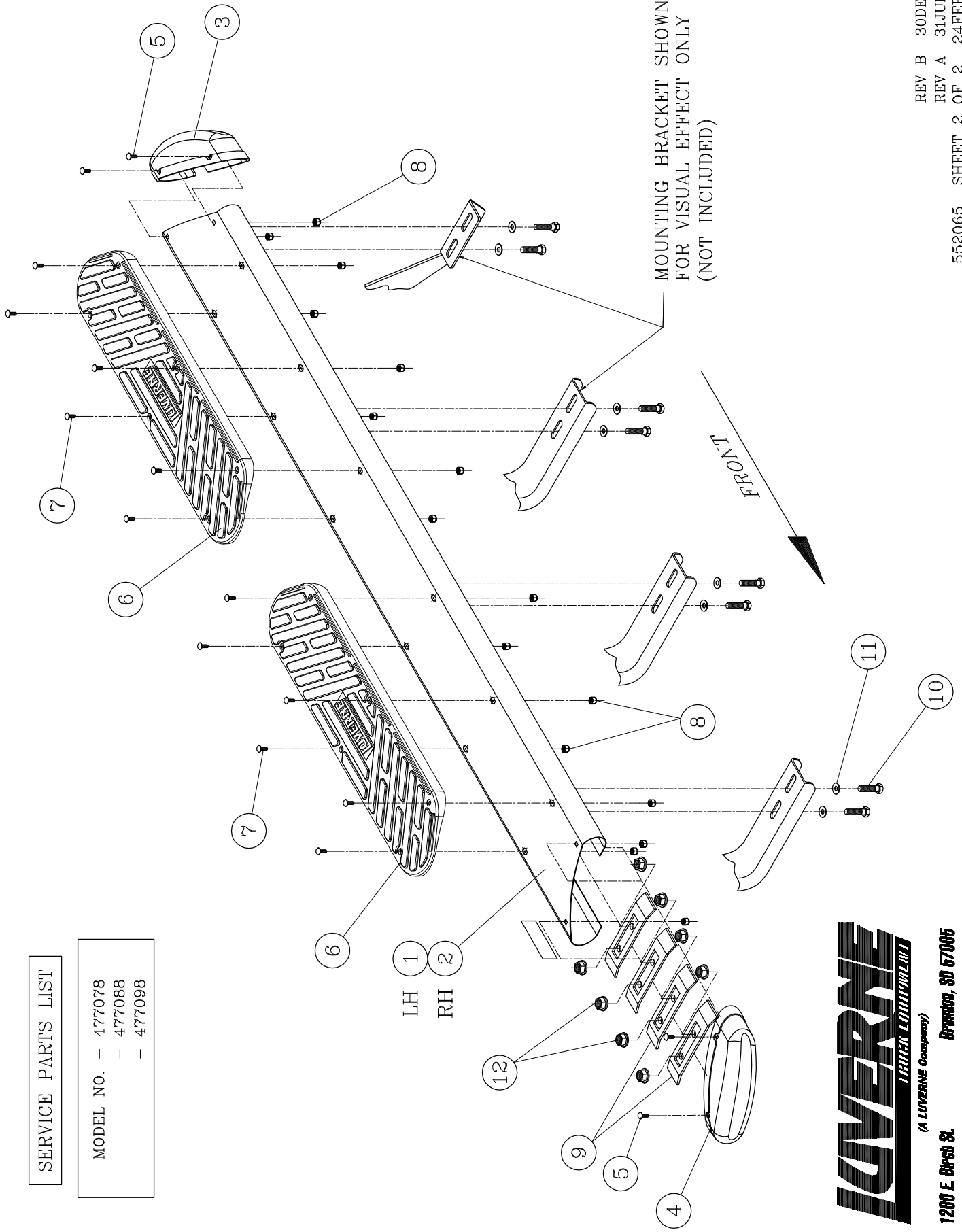

LOVERNE
 TRUCK EQUIPMENT
 (A LOVERNE Company)

1200 E. Birch St.
 Brandon, SD 57006

552065 SHEET 2 OF 2 24FEB12
 REV A 31JUL12
 REV B 30DEC15



INSTALLATION INSTRUCTIONS AND PARTS LIST
APPLICATION: MODEL **401743** GRIP-STEP/REGAL 7 BRACKETS ON:
2015+ GM 2500/3500HD DOUBLE & CREW CAB PICKUPS, GAS/DIESEL
BODY MOUNT APPLICATION



NO DRILL APPLICATION

1. READ INSTRUCTIONS COMPLETELY AND CHECK TO MAKE SURE THAT ALL REQUIRED PARTS (LISTED ON SERVICE PARTS LIST) ARE ON HAND BEFORE STARTING THE INSTALLATION.
2. ON THE LEFT SIDE OF THE VEHICLE PREASSEMBLE THE FRONT BRACKET (ITEMS #1, 3, 14) AS SHOWN IN **FIG. 1** USING THREE 3/8"-16 X 1.0" SCREWS, 3/8" FLAT WASHER AND 3/8" FLANGE NUTS (ITEMS #10, 11, 13). TORQUE TO 19 LB. FT.
3. ASSEMBLE THE LOAD REACTION STUDS AND HARDWARE (ITEM #9 THRU #12) AS FOLLOWS.
 - 3.1. ON THE SHORT THREADED END OF THE LOAD REACTION STUD (ITEM #12), INSTALL A 3/8" SERRATED FLANGE NUT (ITEM #11) BACKWARDS TO THE BOTTOM OF THE THREAD. THEN INSTALL A 3/8" FLAT WASHER (ITEM #10) AND RUBBER "CUSHION" WASHER (ITEM #9) TIGHT UP AGAINST THE SERRATED FLANGE NUT. (THE END OF THE STUD MUST BE RECESSED IN THE RUBBER WASHER APPROX. 3/16").
 - 3.2. ON THE LONG THREADED END OF THE STUD, INSTALL A 3/8" SERRATED FLANGE NUT (ITEM #12) BACKWARDS TO NEAR TO THE BOTTOM OF THE THREADS
4. ATTACH THE LOAD REACTION STUD ASSEMBLIES TO THE MOUNTING BRACKETS AS SHOWN IN **FIG. 4**. INSERT THE STUD, FROM WHAT WILL BE THE INBOARD OR FRAME SIDE THRU THE LOWEST HOLE IN THE BENT FLANGE OF THE BRACKET THAT WILL ALLOW THE RUBBER WASHER TO SEAT FIRM AGAINST THE SIDE WALL OF THE FRAME. INSTALL A 3/8" SERRATED FLANGE NUT (ITEM #11) ON THE OUTBOARD END OF THE STUD (FINGER TIGHT ONLY).

NOTE:

DUE TO EXCESSIVE THREAD LOCKER IN THE BODY MOUNT BOLT AREA ON THE 2010+ GM SILVERADO/SIERRA, USE CAUTION WHEN REMOVING THE BODY MOUNT BOLTS.

5. REMOVE THE FACTORY FRONT, CENTER, AND REAR BODY MOUNT BOLTS AND INSTALL THE MOUNTING BRACKETS PER THE FOLLOWING INSTRUCTIONS:
 - 5.1. INSTALL THE FRONT MOUNTING BRACKET (ITEMS #1, 3) TO THE FRONT BODY MOUNT AS SHOWN (LEAVE THESE FASTENERS FINGER TIGHT).
 - 5.2. INSTALL THE CENTER MOUNTING BRACKET (ITEM #4) TO THE CENTER BODY MOUNT AS SHOWN (LEAVE THESE FASTENERS FINGER TIGHT).
 - 5.3. INSTALL THE REAR MOUNTING BRACKET (ITEM #8) & WASHER (ITEM #15) TO THE REAR BODY MOUNT AS SHOWN (LEAVE THESE FASTENERS FINGER TIGHT).
 - 5.4. ATTACH THE REAR OUTBOARD MTG BRKT (ITEM #6) TO THE REAR INBOARD MTG BRKT (ITEM #8), USING THREE 3/8"-16 X 1.0" SCREWS, 3/8" FLAT WASHERS AND 3/8" FLANGE NUTS. (ITEMS #13, 10, 11). THE REAR OUTBOARD MOUNTING BRACKET MUST BE MOUNTED TO THE BACK SIDE OF THE REAR INBOARD MOUNTING BRACKET (TOWARDS THE REAR OF THE VEHICLE) AS SHOWN IN FIG 2 AND 3. BE SURE TO USE THE CORRECT HOLES AS SHOWN IN FIG. 2 & 3. NOTE THAT THERE IS A DIFFERENCE BETWEEN THE DOUBLE CAB AND CREW CAB APPLICATIONS. TORQUE THE BOLTS TO 19 LB. FT.

6. INSTALL THE STEP BOARDS AS DESCRIBED BY THE INSTRUCTIONS INCLUDED WITH YOUR STEP BOARDS. **(NOTE: INSURE THAT THE MOUNTING BRACKETS DO NOT TOUCH THE INSIDE WALL OF THE BODY MOUNT HOUSING AND TORQUE THE BODY MOUNT FASTENERS TO MANUFACTURES SPECS).**
7. POSITION THE LOAD REACTION BOLT ASSEMBLY SO THAT THE RUBBER CUSHION IS SNUG UP AGAINST THE SIDE OF THE FRAME. TIGHTEN THE 3/8" FLANGE NUTS ON EITHER SIDE OF THE BRKT TO 19LB. FT.
8. REPEAT STEPS 1-8 FOR THE RIGHT SIDE OF THE VEHICLE.

SERVICE PARTS LIST

ITEM	PART NO.	QTY	DESCRIPTION
1	552729	1	BRACKET-MTG, FRONT, LH, 401743
2	553124	1	BRACKET-MTG, FRONT, RH, 401743
3	552718	2	BRACKET-MTG, FRONT, INBOARD, 401743
4	552731	1	BRACKET-MTG, CENTER, LH, 401743
5	552730	1	BRACKET-MTG, CENTER, RH, 401743
6	552733	1	BRACKET-MTG, REAR, LH, 401743
7	552732	1	BRACKET-MTG, REAR, RH, 401743
8	551826	2	BRACKET-MTG, REAR, INBOARD, LH/RH, 581543
9	102592	6	WSHR, RUBBER, .354 ID X 1.00 OD X .75 THK
10	100062	20	WSHR, FL, 3/8", .438 ID X 1.00 OD X .083" THK
11	100181	30	NUT, SERR FLG, HEX, 3/8-16 UNC, ZP
12	104686	6	STUD, -DBL ENDED, STL, 3/8-16 X 4.00", ZP
13	100040	12	SCR-HEX HD, 3/8-16 UNC, ZP
14	551571	2	BRACKET-90 DEGREE, 3 HOLE
15	108882	2	WSHR, FL, .59 ID X 1.06 OD X .19 THK, ZP

SERVICE PARTS LIST

MODEL NO. 401743

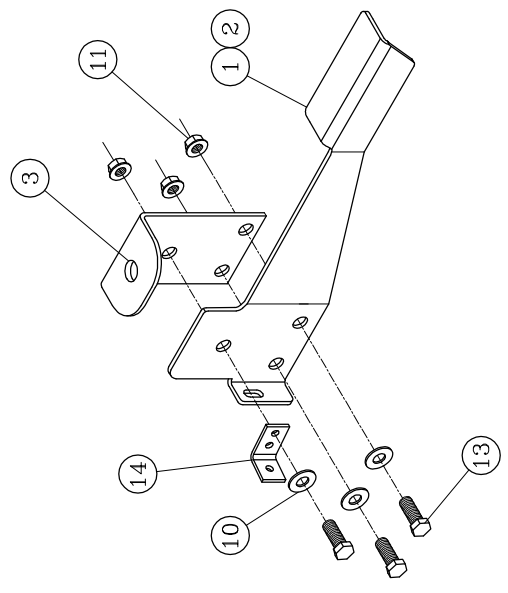

FRONT BRACKET ASSEMBLY

FIG. 1

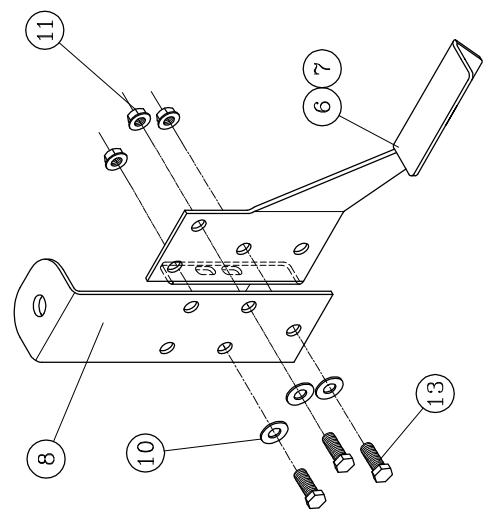

DOUBLE CAB REAR BRACKET ASSEMBLY

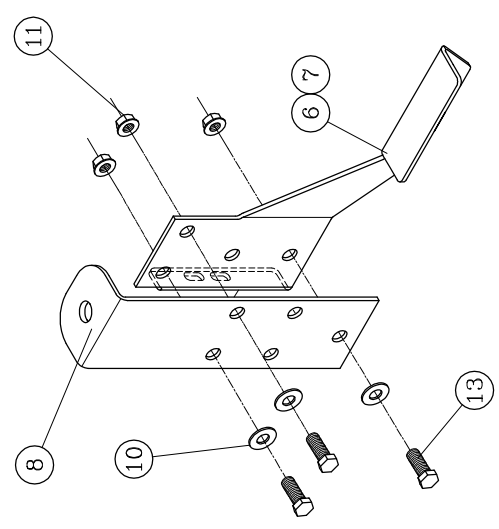

CREW CAB REAR BRACKET ASSEMBLY

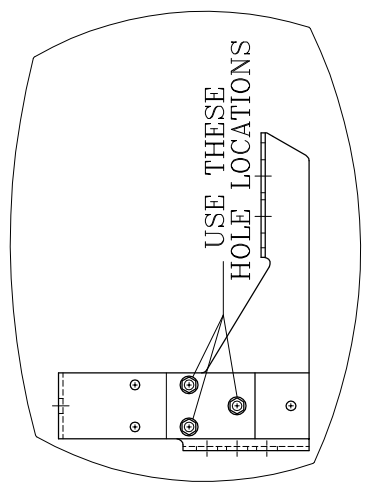

FIG. 2

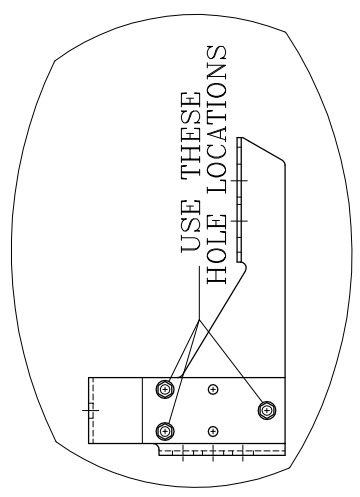

FIG. 3



SERVICE PARTS LIST

MODEL NO. 401743

GM DOUBLE CAB GM CREW CAB

FIG. 4

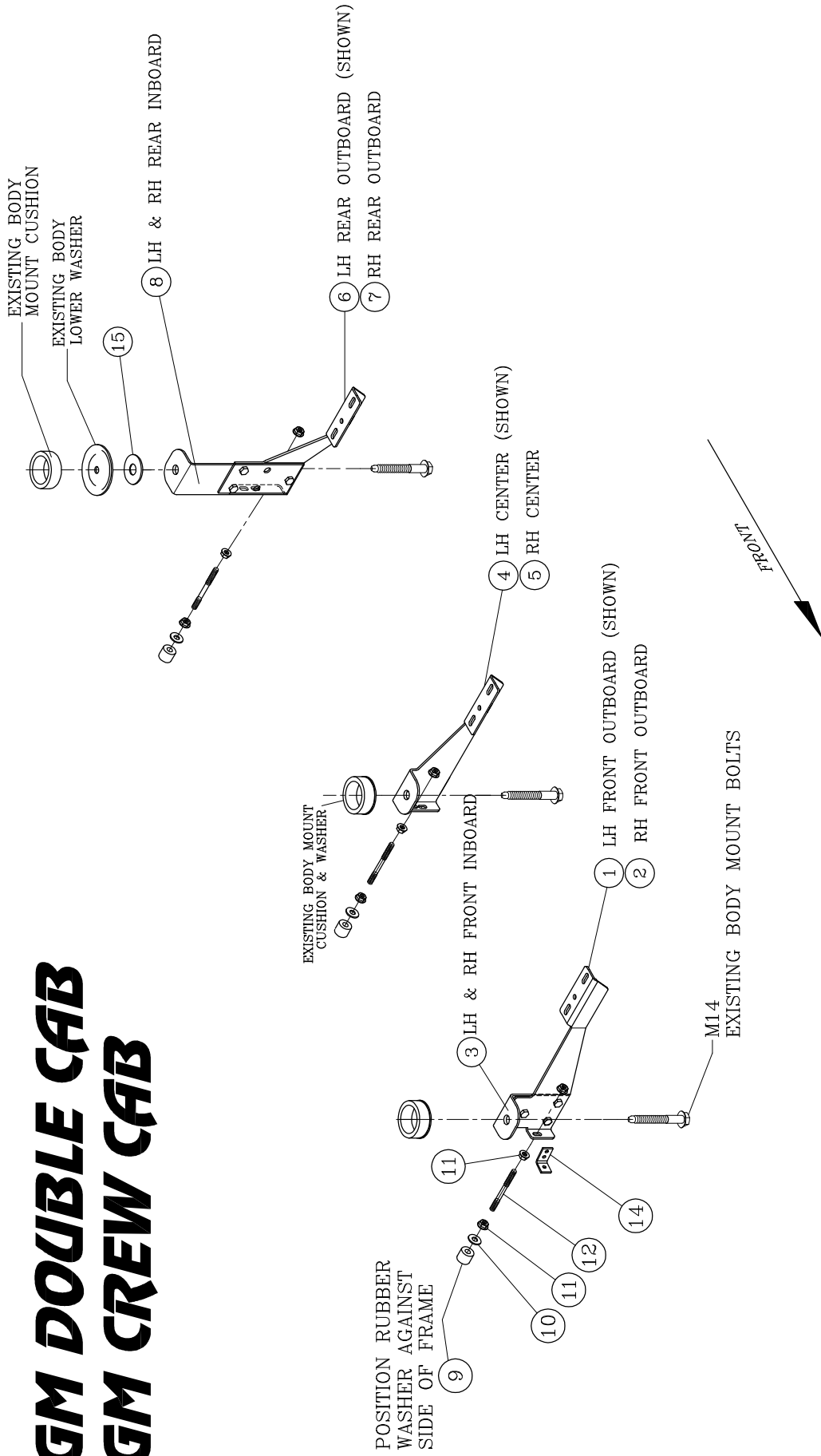

LEFT (DRIVER) SIDE SHOWN
-RIGHT (PASSENGER) SIDE OPPOSITE-

