

INSTALLATION INSTRUCTIONS AND PARTS LIST
APPLICATION: MODEL 571521 MEGA STEP/SES BRACKETS ON:
2015+ FORD F150 REGULAR CAB AND EXTENDED CAB PICKUPS
ROCKER PANEL MOUNT APPLICATION



NO DRILL APPLICATION

1. READ INSTRUCTIONS COMPLETELY AND CHECK TO MAKE SURE THAT ALL REQUIRED PARTS (LISTED ON SERVICE PARTS LIST) ARE ON HAND BEFORE STARTING THE INSTALLATION.
2. ON THE LEFT SIDE OF THE VEHICLE INSTALL TWO 1.5" ISOLATOR WASHERS (ITEM #3) THE STEP MOUNTING BRACKET (ITEM #2) AND TWO M8-1.25 FLANGE NUTS (ITEM #4) ON THE FACTORY PROVIDED STUDS ON THE INSIDE OF THE ROCKER PANEL AS SHOWN IN FIGURE 1.

NOTE: IF INSTALLING STAINLESS STEEL SIDE ENTRY STEPS LEAVE THE FLANGE NUTS FINGER TIGHT ONLY TO ASSIST ALIGNMENT OF THE STEP PLATE.

3. REPEAT STEP 2 FOR THE REMAINING BRACKETS.
4. CHECK THAT ALL BRACKETS ARE LEVEL AND TIGHTEN ALL FLANGE NUTS.
5. REPEAT STEPS 2 – 4 FOR THE RIGHT SIDE OF THE VEHICLE.

ATTACHING THE STEP BOARDS TO THE BRACKETS:

PLEASE REFER TO THE INSTRUCTION SHEET INCLUDED WITH YOUR STEP BOARD ASSEMBLY TO MOUNT THE STEP TO THE BRACKETS.

SERVICE PARTS LIST

ITEM	PART NO.	QTY	DESCRIPTION
1		1	STEP ASSY, MEGA STEP / O-MEGA STEP / SES
2	552643	4	BRACKET-MTG, MEGA STEP/O-MEGA STEP/SES, 571521
3	108442	8	WASHER – NYLON, .36" X 1.5" X .032" BLACK
4	105859	8	NUT- FLANGE, M8-1.25, ZP



(A LIVERNE Company)

1200 E. Birch St.

Brandon, SD 57005

552822 SHEET 1 OF 2 20JAN15

SERVICE PARTS LIST

MODEL NO. - 571521

2015 FORD F150 REGULAR/SUPER CAB

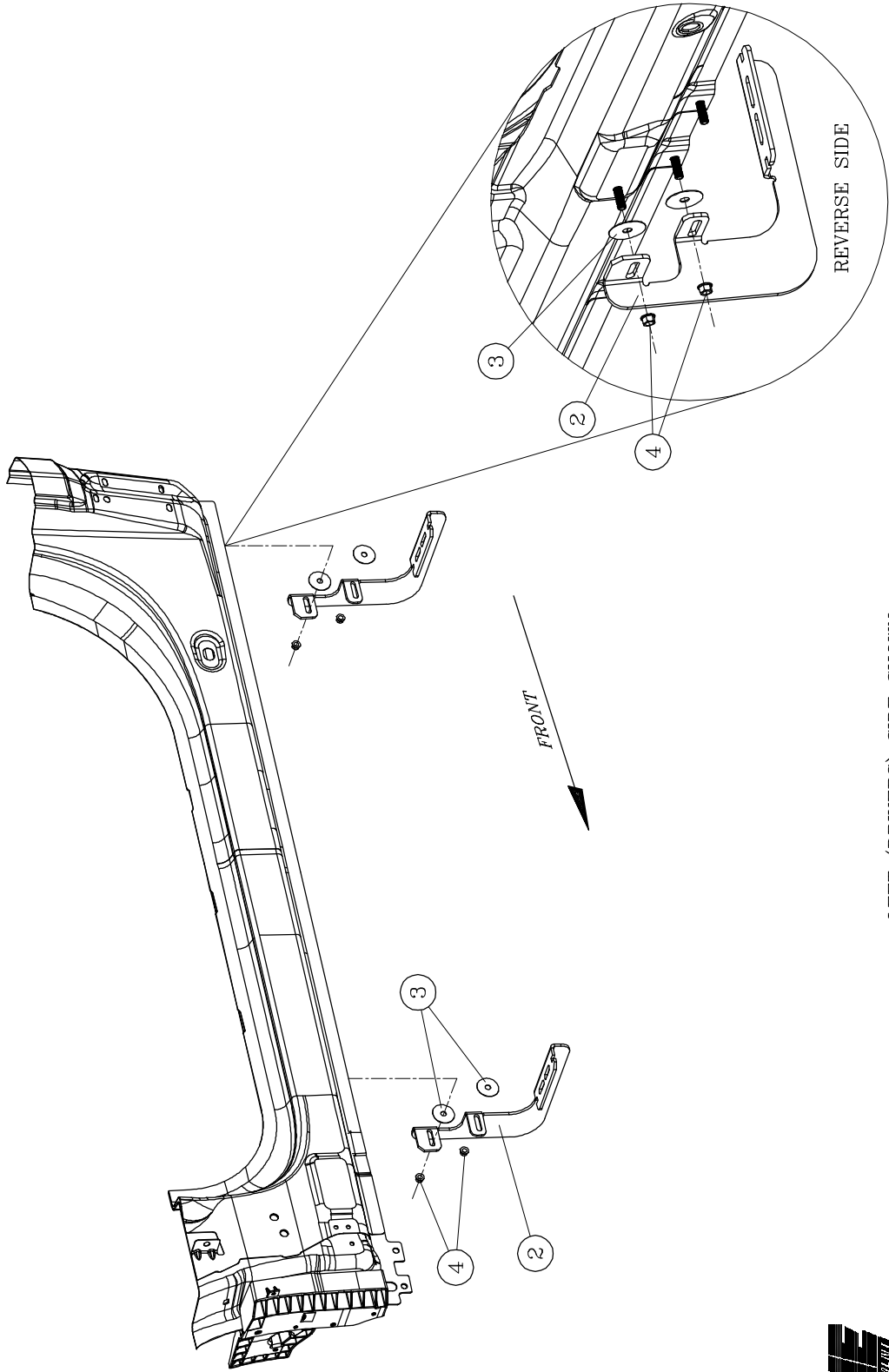

- LEFT (DRIVERS) SIDE SHOWN -
- RIGHT (PASSENGER) SIDE OPPOSITE -

LOVERNE
A LOVERNE COMPANY
17500 E. 29th St.
Denver, CO 80238