

LoadLifter 7500 XL™ + Air Lift® ULTIMATE ProSeries XL



Installation Guide



Watch the video
Info on Table of Contents page

Ford SD F-450 4WD (Dual Rear Wheel)

Kit 57579 | 99579

For maximum effectiveness and safety, please read these instructions completely before proceeding with installation.

Failure to read these instructions can result in an incorrect installation.

Protect your Air Lift Purchase by Completing your Warranty Registration

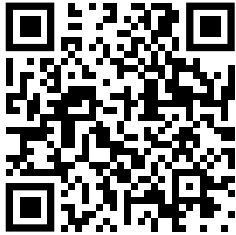

Thank you for purchasing an Air Lift load support product!

Take a photo of your sales receipt and then scan the QR code to complete your online warranty registration.

TABLE OF CONTENTS

2 System Overview

3 Hardware and Tools

4 Introduction

Notation Explanation

5 Install the System

Prepare the Vehicle
Install the Upper Frame Brackets
Air Spring and Bracket Assembly
Prepping the Vehicle
Install the Braces
Install the Air Spring Assemblies

17 Install the Air Lines

Install the Heat Shield

19 Finished Installation

20 Before Operating

Installation Checklist
Maintenance and Use Guidelines

21 Limited Warranty and Return Policy

Video-enhanced installation guides

Visit airliftcompany.com/workshop/category/install-videos to access our installation video archive*.

System Overview

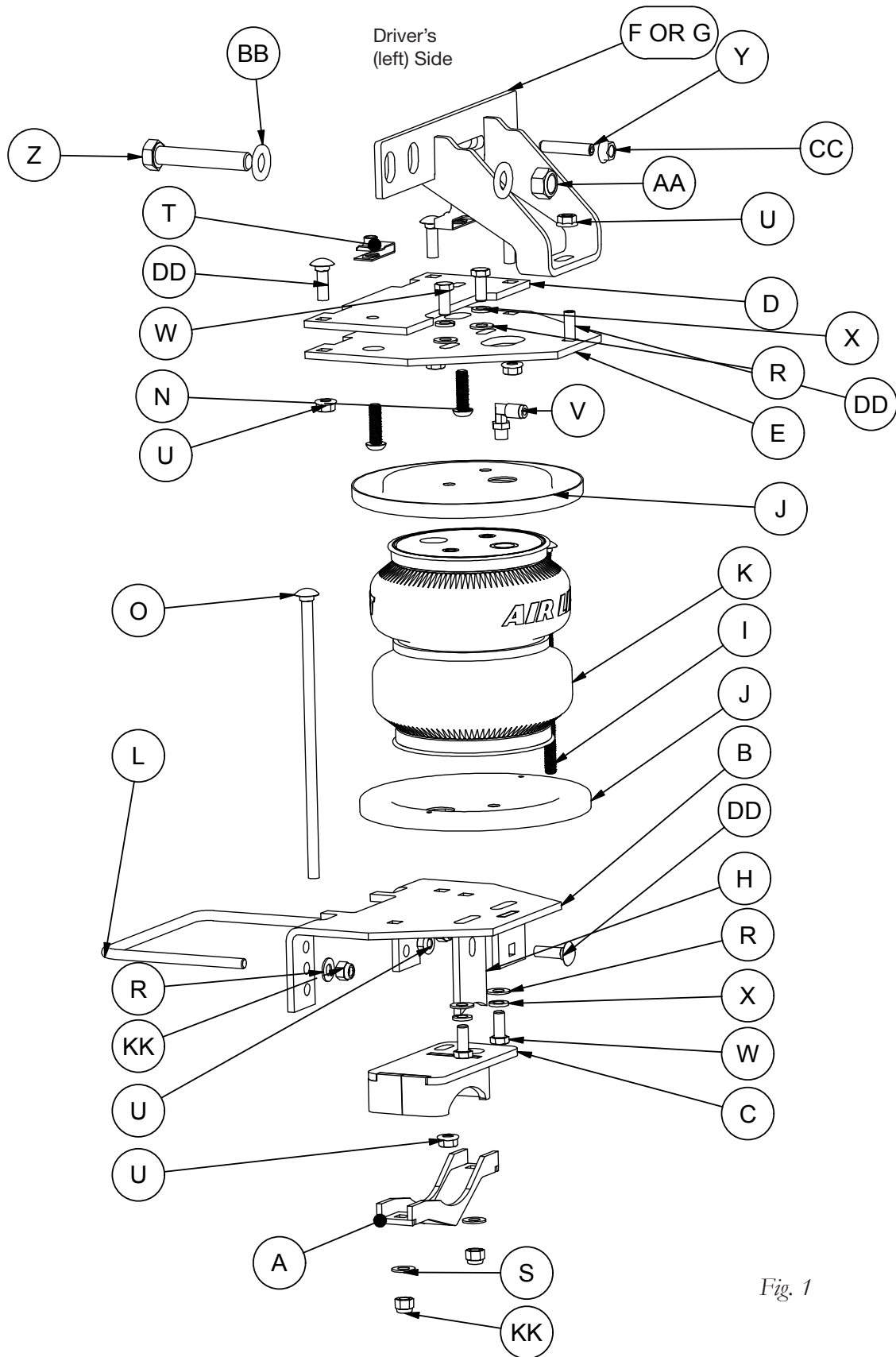

Fig. 1

Hardware and Tools Lists

COMMON PARTS INCLUDED IN BOTH KITS

Item	Part#	Description	Qty
A	01537	Clamp bar	2
B	03069	Lower bracket	2
C	03224	Lower bracket, cup	2
D	07974	Upper frame bracket.....	2
E	07925	Upper air spring bracket	2
F	07895	RH upper frame brace	1
G	07645	LH upper frame brace.....	1
H	11689	Lower leg adapter.....	2
I	17152	3/8"-16 x 8" Carriage bolt.....	2
L	11770	U-bolt	2
M*	11173	90-degree Treemount.....	1
N	17366	M10-1.5 x 35mm Button-head cap screw.....	4
O	17387	3/8"-16 x 10" Carriage bolt.....	2
Q*	17101	3/8"-16 x 3/4" Hex cap screw.....	1
R	18444	3/8" Flat washer	17
S*	18501	M8 Flat washer.....	2
T	18622	M10-1.5mm, Short universal nut	4
U	18422	3/8"-16 Serrated flange lock nut.....	13
V	21837	1/8" NPT x 1/4" PTC swivel 90-degree fitting	2
W	17203	3/8"-24 x 7/8" Hex bolt.....	8
X	18427	3/8" Lock washer.....	8
Y	17525	M10 x 1.5 x 50mm Set screw	1
Z	17348	5/8"-11 x 4 1/2" Hex cap screw.....	3
AA	18548	5/8"-11 Nylon lock nut.....	3
BB	18449	5/8"-11 Flat washer.....	6
CC	18651	M10 x 1.5 Serrated flange lock nut.....	1
DD	17134	3/8"-16 x 1" Carriage bolt.....	12
EE*	10466	Zip ties	6
FF*	21230	Valve cap.....	2
GG*	21234	Rubber washer.....	2
HH*	18411	Small star washer.....	2
II*	21233	5/16" Hex nut	4
JJ*	20086	Air line assembly	1
KK	18435	3/8"-16 Nylon lock nut.....	8
LL*	11151	P-clamp.....	1
MM*	17175	1/4"-20 x 3/4" Hex cap screw.....	1
NN*	18425	1/4"-20 Nylon lock nut.....	1
OO*	18541	1/4" Flat washer	2

* These parts are not shown in the Installation Diagram (Fig. 1).

UNIQUE PARTS IN EACH KIT

LoadLifter 7500 XL™ **ULTIMATE** KIT 57579

Item	Part#	Description	Qty
J	11897	Roll Plate.....	4
K	58120	Air Spring	2

Air Lift® ProSeries XL KIT 99579

Item	Part#	Description	Qty
J	11897	Roll Plate.....	4
K	58120	Air Spring	2

TOOLS LIST

Description.....	Qty
Metric & standard open-end box wrenches.....	set
Ratchet with metric and standard sockets.....	set
Drill and 5/16" drill bit.....	1
Torque wrench.....	1
Hex key wrenches metric and standard.....	set
9/16" Crows foot adapter	1
9/16" Ratchet combo wrench	1
Mid-size adjustable wrench.....	2
Hose cutter, razor blade or sharp knife	1
Hoist or floor jack	1
Safety stands.....	2
Safety glasses	1
Air compressor or compressed air source	1
Spray bottle with dish soap/water solution.....	1



Missing or damaged parts? Call Air Lift customer service at (800) 248-0892 for a replacement part.

Introduction

The purpose of this publication is to assist with the installation and maintenance of the LoadLifter 7500 XL Ultimate and Air Lift ProSeries XL air spring kits. LoadLifter 7500 XL Ultimate and Air Lift ProSeries XL air spring kits utilize sturdy, reinforced, commercial-grade double-convolute bellows.

The air springs are manufactured like a tire with layers of rubber and cords that control growth. LoadLifter 7500 XL Ultimate and Air Lift ProSeries XL air spring kits are recommended for most 3/4- and 1-ton pickups and SUVs with leaf springs and provide up to 7,500 pounds (3,402kg) of load-leveling support with air adjustability from 5-100 PSI (.34-7BAR).

It is important to read and understand the entire installation guide before beginning installation or performing any maintenance, service or repair.

NOTATION EXPLANATION

Hazard notations appear in various locations in this publication. Information highlighted by one of these notations must be observed to help minimize risk of personal injury or possible improper installation, which may render the vehicle unsafe. Notes and Tech Tips are used to help emphasize areas of procedural importance and provide helpful suggestions. The following definitions explain the use of these notations as they appear throughout this guide.



DANGER

INDICATES IMMEDIATE HAZARDS WHICH WILL RESULT IN SEVERE PERSONAL INJURY OR DEATH.



WARNING

INDICATES HAZARDS OR UNSAFE PRACTICES WHICH COULD RESULT IN SEVERE PERSONAL INJURY OR DEATH.



CAUTION

INDICATES HAZARDS OR UNSAFE PRACTICES WHICH COULD RESULT IN DAMAGE TO THE VEHICLE OR MINOR PERSONAL INJURY.



NOTE

Used to help emphasize areas of procedural importance and provide helpful suggestions.



TECH TIP

Used to provide helpful tips to ease the installation process.

Install the System

PREPARE THE VEHICLE

1. Raise the vehicle and support it in a way, using safety stands or equivalent, that the axle can be safely lowered away from the frame. This will need to be done in order for the air spring assembly to be put into position between the axle and frame (Fig. 2).

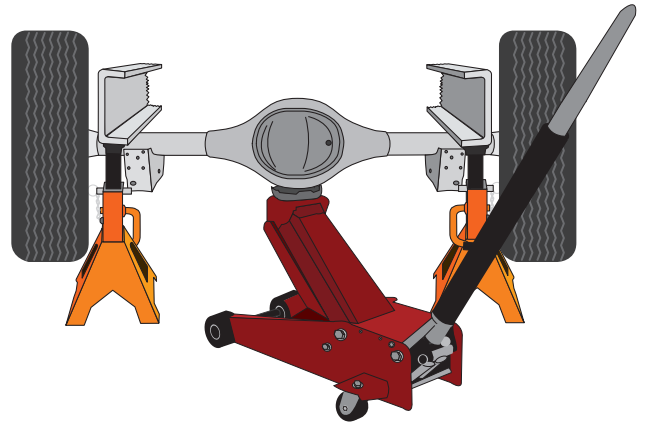

Fig. 2

INSTALL THE UPPER FRAME BRACKETS

1. Unbolt and remove the jounce bumper assembly from under the frame on both sides (Fig. 3).



Fig. 3

2. Remove the clip-in studs by prying on the hinged end with a screwdriver to release. Pull all four clip-in studs out of the frame (Fig. 4).

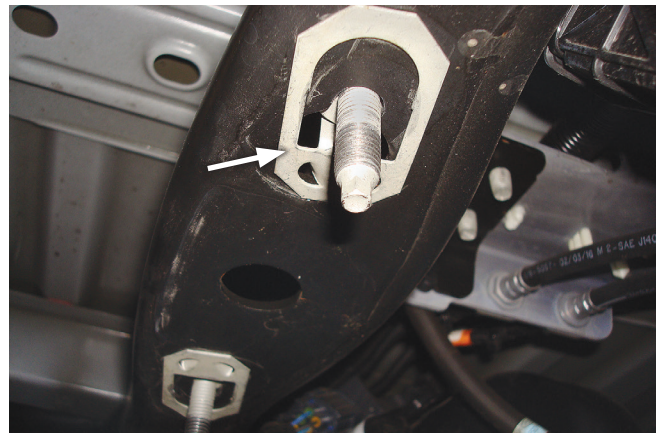

Fig. 4

3. Install the (2) universal nuts (T) into the frame rail, lining up the holes in the frame and the threads in the nuts so that a bolt can be installed (Fig. 5).



TECH TIP

A flat-tipped screwdriver works well for installing the universal nut into position.

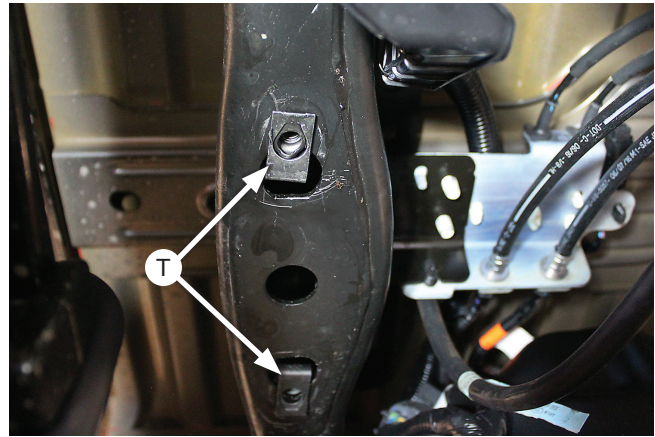

Fig. 5

4. Insert three (3) 3/8"-16 x 1" carriage bolts (DD) into the upper frame bracket (D). Install the upper frame bracket onto the frame using (2) M10-1.5 x 35mm button-head cap screws (N) so that the large cut-out on the side of the bracket is inboard of the frame rail and the slotted hole in the center is forward (Fig. 6). Torque hardware to 38 lb.-ft. (52Nm).

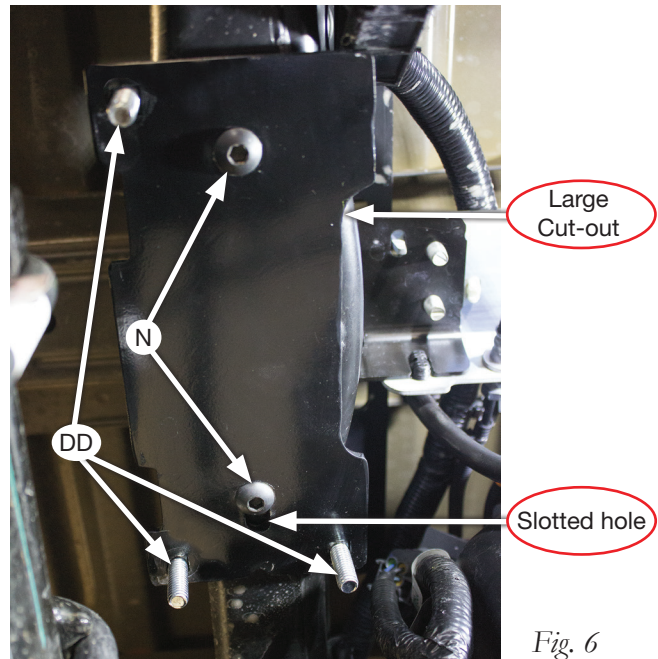

Fig. 6

AIR SPRING AND BRACKET ASSEMBLY

1. Install swivel elbow fittings (V) into the tops of the air springs finger-tight. Tighten the swivel fittings an additional one and a half turns. Place roll plates (J) on top of the air springs. (Fig. 7)

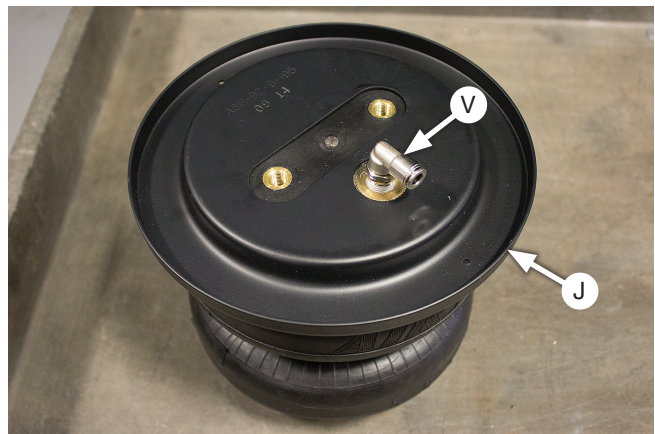

Fig. 7

- Insert two (2) 3/8"-16 x 1" carriage bolts (DD) into the square holes on the brackets, then secure the upper air spring brackets (E) onto the top of the air springs using (4 of each) 3/8"-24 x 7/8" hex bolts (W), 3/8" lock washers (X) and 3/8" flat washers (R). At this stage, the air spring assemblies are left- and right-hand units. Push the brackets as far forward as possible (Fig. 8). Torque the hardware to no more than 20 lb.-ft. (27Nm).

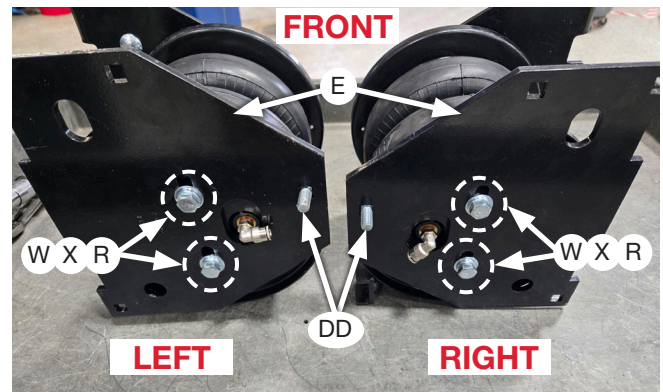

Fig. 8

- Flip the assemblies over and set roll plates (J) onto the bottoms of the air springs as shown in Fig. 9.

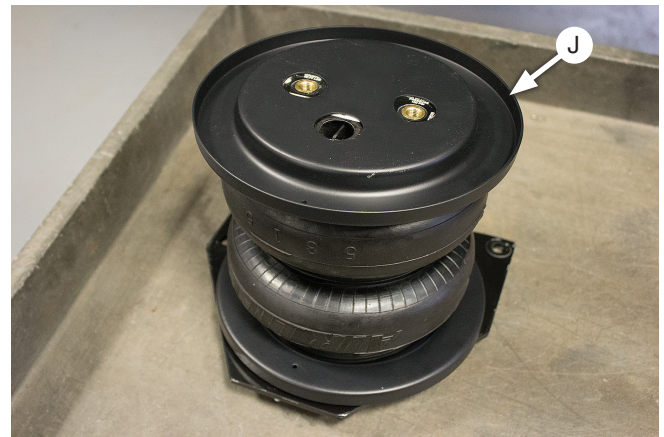

Fig. 9

- Insert one (1) 3/8"-16 X 1" carriage bolt (DD) through the top of the lower bracket (B), as shown in Fig. 10. Flip the assembly over and set the lower bracket cup (C) onto the lower bracket and over the carriage bolt (Fig. 11). Cap with a 3/8"-16 serrated flange lock nut (U) and snug the nut only. Leave loose enough for the bracket to move freely in the slot.

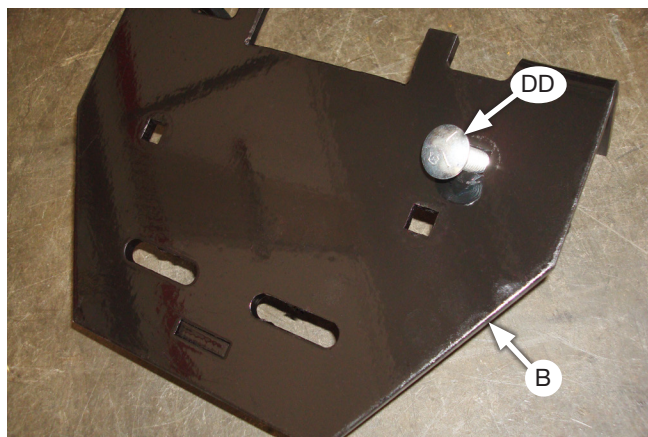

Fig. 10

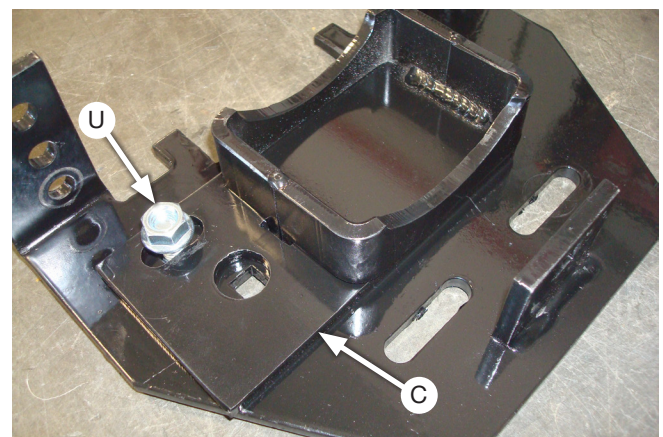

Fig. 11

5. Insert one (1) 3/8"-16 x 10" carriage bolt (O) through the rear remaining square hole and (1) 3/8"-16 x 8" (I) through the front remaining square hole in the lower bracket (B), both sides will be a mirror of each other. (Fig. 12)

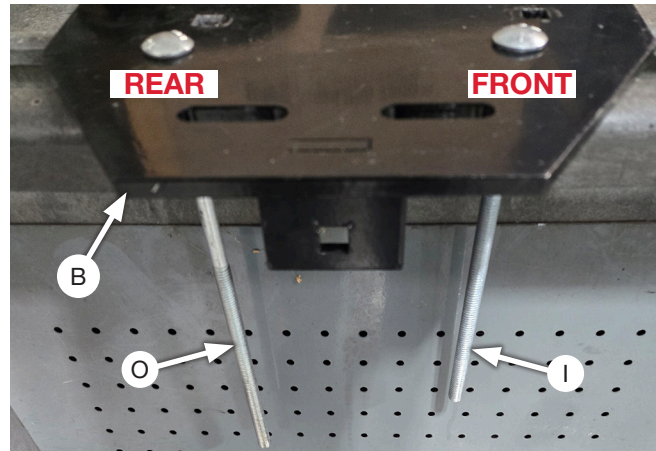

Fig. 12

6. Set the lower bracket assemblies onto the air springs with roll plates installed and attach them with (2 of each) 3/8"-24 x 7/8" hex bolts (W), 3/8" lock washers (X) and 3/8" flat washers (R) (Fig. 13).

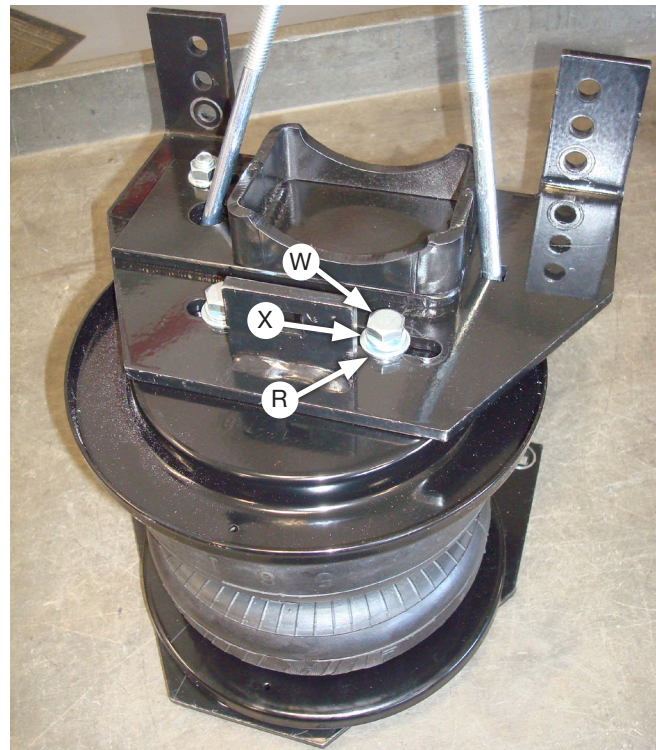

Fig. 13

7. Push the lower bracket as far forward as possible to match the upper bracket (refer to Fig. 14). Torque the hardware to no more than 20 lb.-ft. (27Nm).

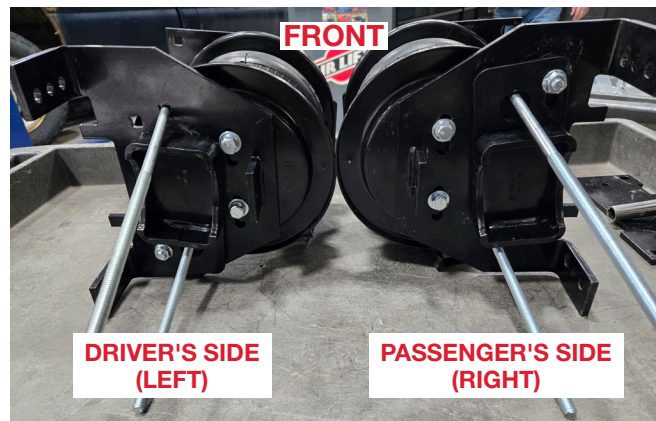

Fig. 14

- Attach the lower leg adapter (H) to the lower bracket using a 3/8"-16 x 1" carriage bolt (DD) and a 3/8" serrated flange lock nut (U) (Fig. 15). Install as shown in Fig. 16, pushing the adapter against the lower bracket and torquing the hardware to 16 lb.-ft. (14Nm).

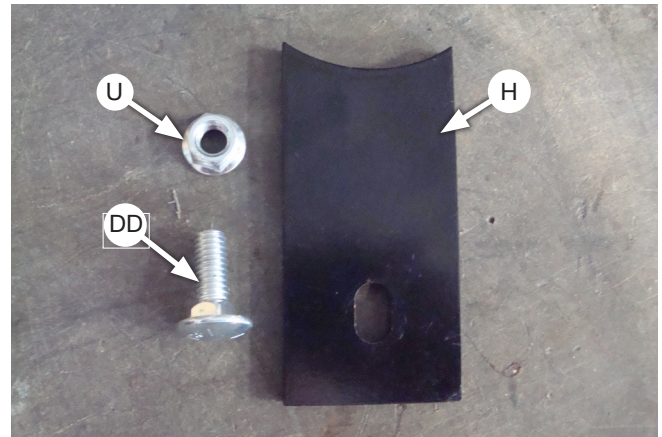

Fig. 15

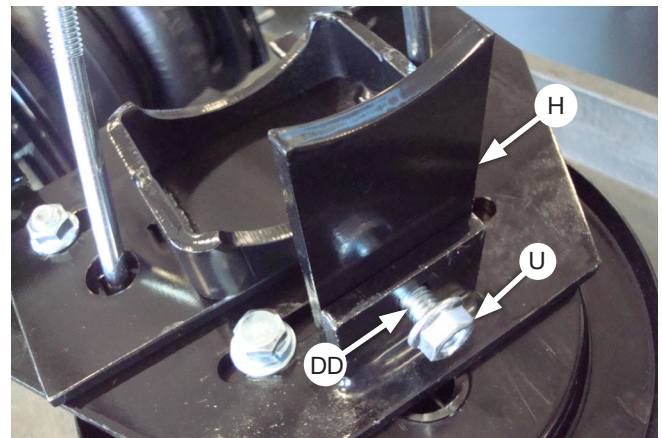

Fig. 16

- Refer to Fig. 17 for the driver's (left) and passenger's (right) side assemblies.



TECH TIP

The leg adapter may need to be loosened, adjusted, and torqued if the leg does not contact the axle.



Fig. 17

PREPPING THE VEHICLE

1. Pry out the top left, bottom left, and the top right ABS harness mounts from the Brake line/ABS harness/vent tube bracket on the axle (Figs. 18 & 19).

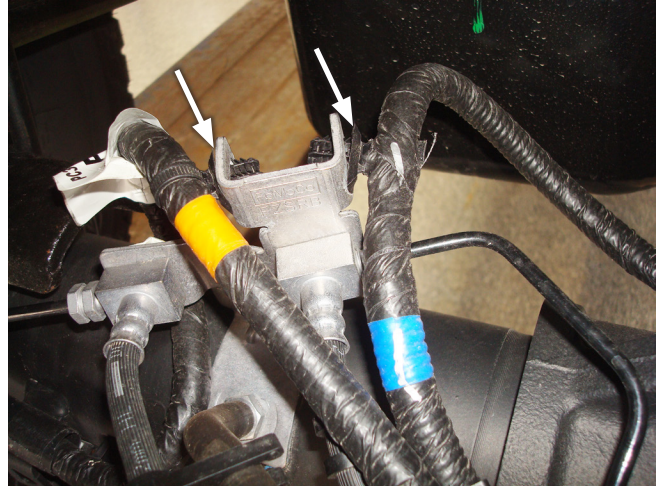

Fig. 18

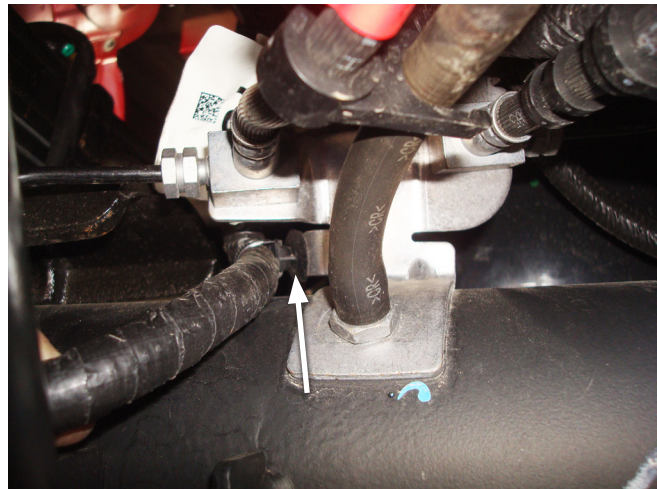

Fig. 19

2. Make clearance for the lower air spring roll plate by bending the upper Brake line/ABS harness/vent tube bracket. Hold the bottom of the bracket by using an adjustable wrench to make the bend (Fig. 20).

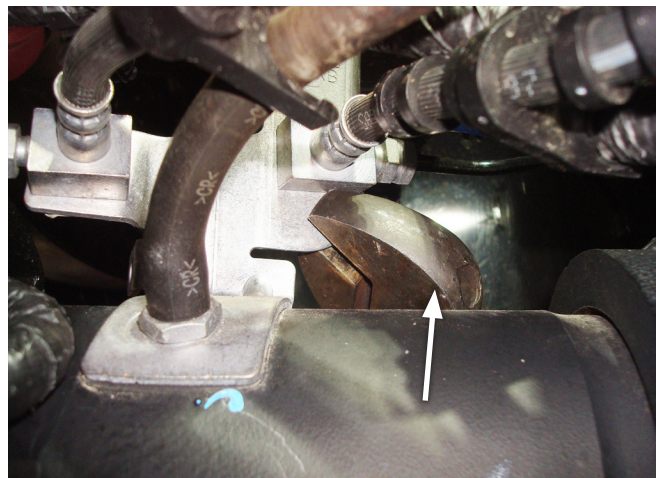

Fig. 20

3. Bend the top of the bracket back and down by using another adjustable wrench (Figs. 21 & 22).

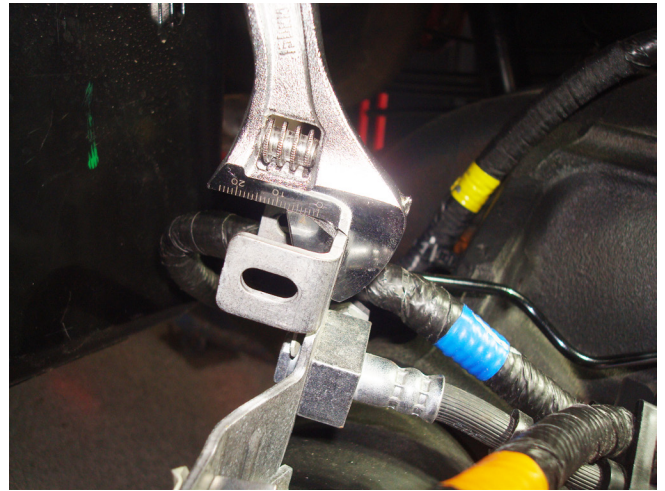

Fig. 21



Fig. 22

4. Install the P-clamp (LL) around the right ABS harness and attach the P-clamp to the inside hole on the bracket section that was just bent (Fig. 23) using the 1/4" hex screw (MM), 2 flat washers (OO) and nylon lock nut (NN).

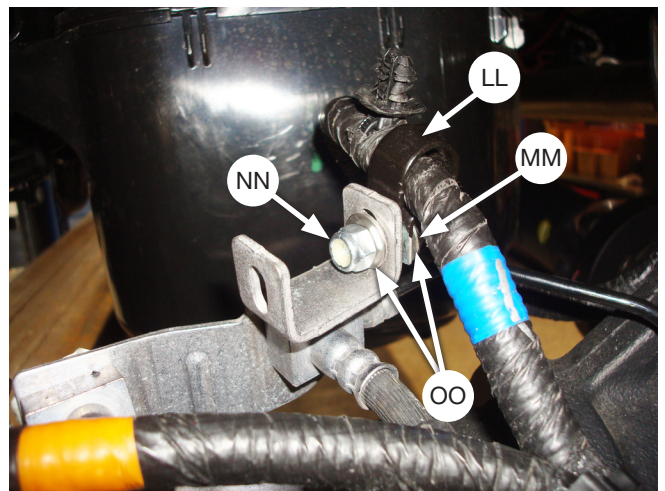

Fig. 23

INSTALL THE BRACES

1. To install the driver's (left) side upper brace (G), if equipped, remove the rearward fifth wheel bracket hardware, set aside for later use (Fig. 24).



Fig. 24

2. Locate the (2) M10 bolts holding the brake line bracket to the frame (Fig. 25). Unbolt both and pull the bracket away from the frame (Fig. 26).

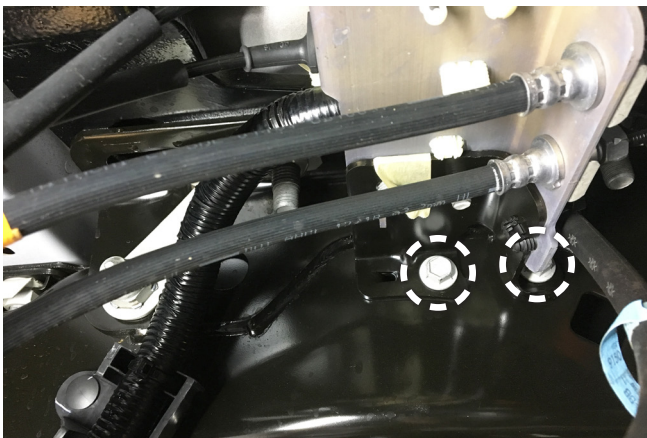

Fig. 25



Fig. 26

3. Install the 50mm set screw (Y) into the rearward threaded hole. Leave about 30mm (1.20") protruding from the frame (Fig. 27).



Fig. 27

4. Set the upper brace (G) in place over the 50mm set screw (Y) and against the frame. Ensure the large slot closest to the middle of the brace lines up with the fifth wheel bracket hole in the frame. Set the stock brake line bracket, previously removed, over the 50mm set screw and on top of the brace. Thread the M10 serrated flange lock nut (CC) onto the set screw. Reinstall the factory fifth wheel hardware previously removed (if equipped) or use the supplied 5/8" (Z, AA, BB) hardware through the frame and brace (Fig. 28). Leave loose at this time.

**CAUTION**

MAKE SURE TO USE THE HOLE THAT HAS THE LONG TUBE REINFORCEMENT GOING THROUGH THE FRAME AS YOUR MOUNTING HOLE. DO NOT USE THE HOLE THAT HAS THE OPEN GAP BETWEEN THE FRAME WALLS.

DO NOT
use this hole
for mounting

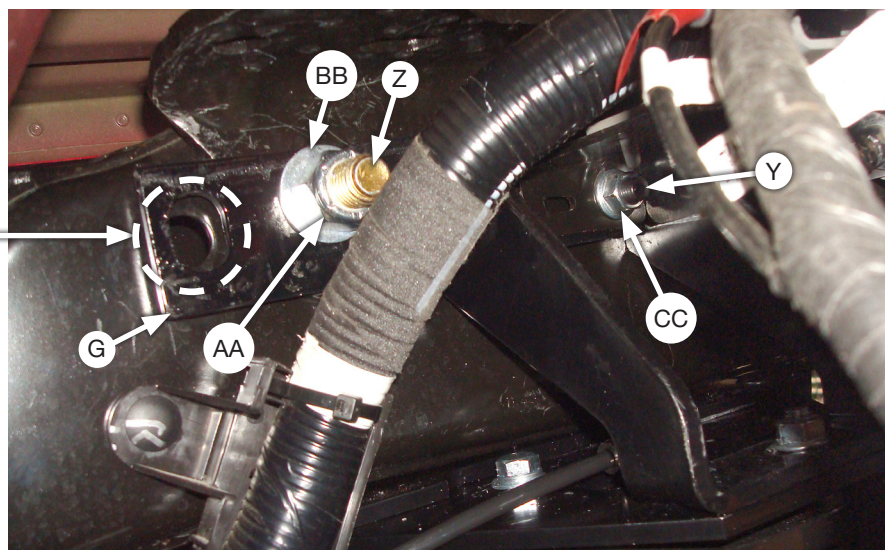

Fig. 28

- To install the passenger's (right) side upper brace (F), locate the clip (circled in Fig. 29) that holds the wiring harness for the O₂ sensor. Remove and discard the clip, as it will no longer be needed.



NOTE

Some models may not have the O₂ sensor clip.

- Remove the factory fifth wheel hitch hardware (if equipped), from the holes in the side of the frame. Using the existing holes in the frame, attach the upper frame brace (F) to the frame using the factory hitch hardware removed or the 5/8" (Z, AA, BB) hardware supplied (Fig. 30). Leave loose at this time.



CAUTION

USE THE REINFORCED HOLE, NOT THE HOLE THAT IS OPEN BETWEEN THE FRAME WALLS.

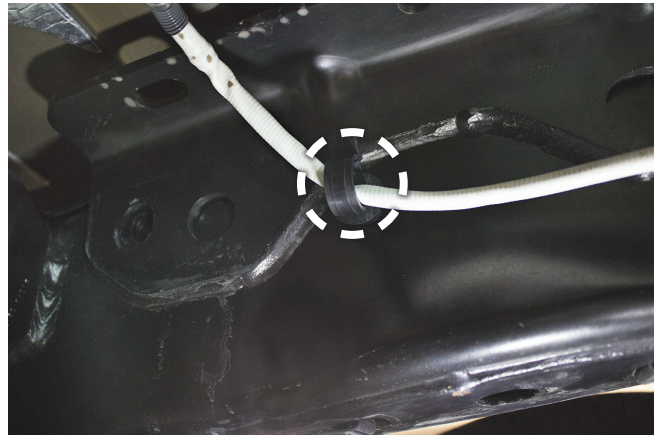

Fig. 29

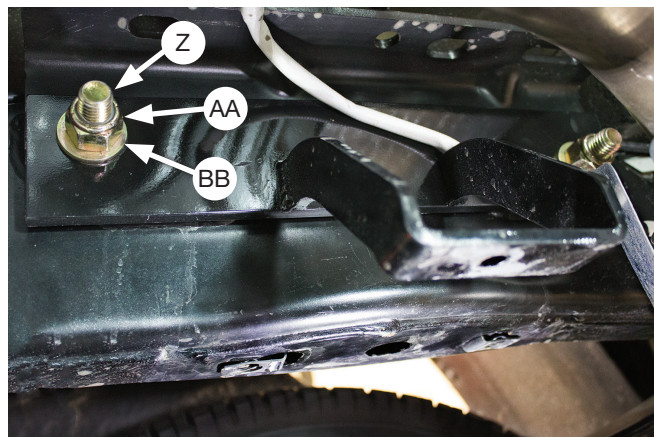

Fig. 30

INSTALL THE AIR SPRING ASSEMBLIES

- With the vehicle supported by safety stands, drop the axle or raise the body so that the assemblies can be put into position in between the axle and frame. Install and position the U-bolts (L) around the axle blocks (Fig. 31). Set the driver's (left) side and passenger's (right) side assemblies into position so that the lower bracket cup rests on the jounce bumper strike plate.



Fig. 31

- Once assemblies are in position on the jounce bumper strike plate or axle, push the lower bracket towards the leaf spring stack while guiding the U-bolt (L) into the topmost accessible hole in the lower bracket main plate (Fig. 32), continue pushing the assemblies until they are flush against the leaf spring stack and both flanges are locked around the stock U-bolts (Fig. 32).



NOTES

The flanges need to be oriented so that they lock around the truck's existing leaf spring U-bolts.

On both sides, the long carriage bolt in the lower bracket will be between the hard brake line and axle.

- Cap with the U-bolt (L), 3/8" flat washer (R) and 3/8" nylon lock nuts (KK) (Fig. 33). Snug bolts evenly, just enough to hold the lower bracket main plate flush against the stock U-bolts.
- Before proceeding, ensure the 90-degree fittings are pointing inboard toward the center of the vehicle. While raising the axle or lowering the body of the vehicle, align the previously installed upper frame bracket carriage bolts (including the one on the air spring bracket) with the air spring bracket/frame brace holes so the carriage bolts protrude. Cap all the carriage bolts with the 3/8" Serrated flange lock nuts (U) (Fig. 34). Snug the bolts down first, then torque to 31 lb.-ft. (42Nm).
- Torque the frame brace/fifth wheel 5/8" hardware supplied (Z, AA, BB if used) to 150 lb.-ft. (203Nm). If using the stock fifth wheel hardware removed, torque to 180 lb.-ft. (244Nm).
- Torque the M10 serrated flange lock nut (CC) on the driver's (left) side brace to 37 lb.-ft. (50Nm).
- Finish raising the axle or lowering the body and remove the safety stands.
- Set the lower clamp bars (A) over the carriage bolts located under the axle, the higher portion of the lower clamp bar needs to go towards the front of the vehicle (Fig. 35). Attach with 3/8" flat washers (R) and nylon lock nuts (KK). Evenly torque the lower clamp bar hardware to 16 lb.-ft. (22Nm).



TECH TIP

It may be necessary to use a 9/16" crows foot adapter to properly torque the hardware.

- Finish tightening the U-bolt hardware previously snugged by torquing to 10 lb.-ft. (14Nm).

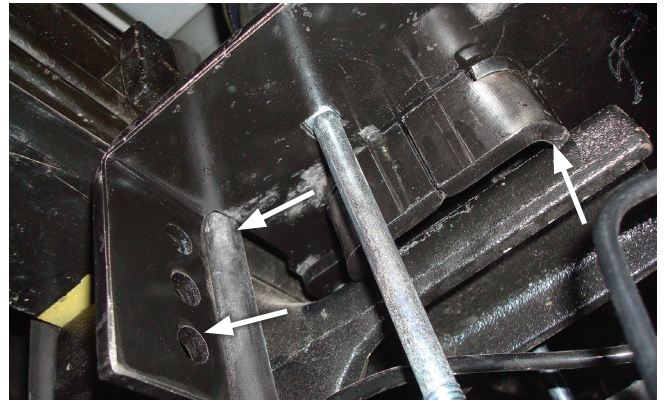

Fig. 32

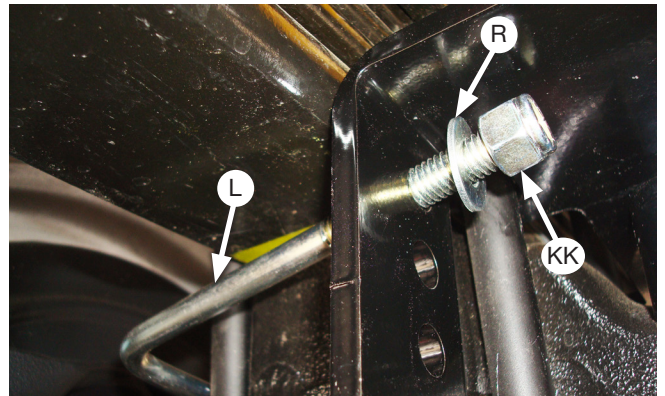

Fig. 33

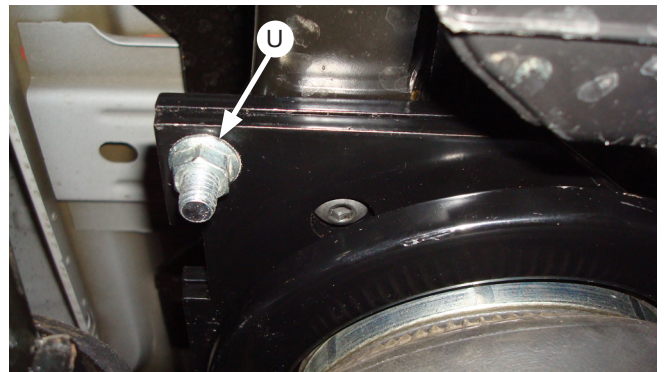

Fig. 34

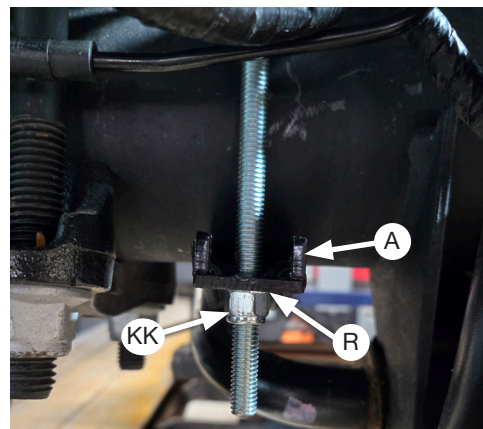

Fig. 35

10. Torque the nut (U) to 32 lb.-ft. (43Nm) on both sides (Fig. 36).

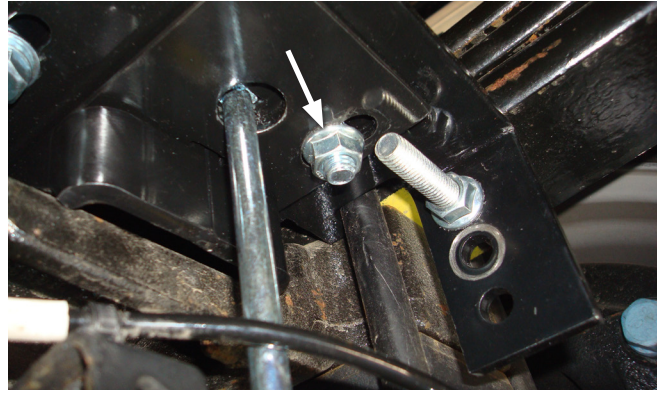

Fig. 36

11. The axle vent tube will also have to be zip-tied to one of the brake soft lines to keep it out of the way of the air spring assembly (Figs. 37 & 38).

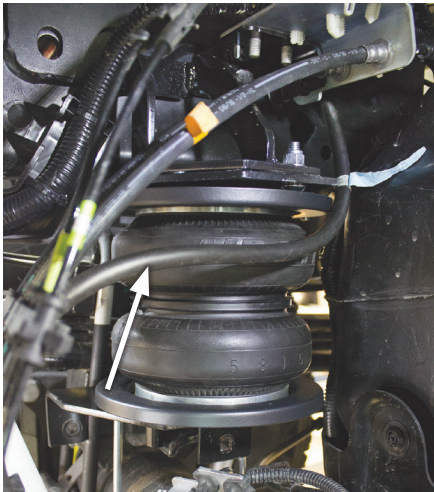

Fig. 37

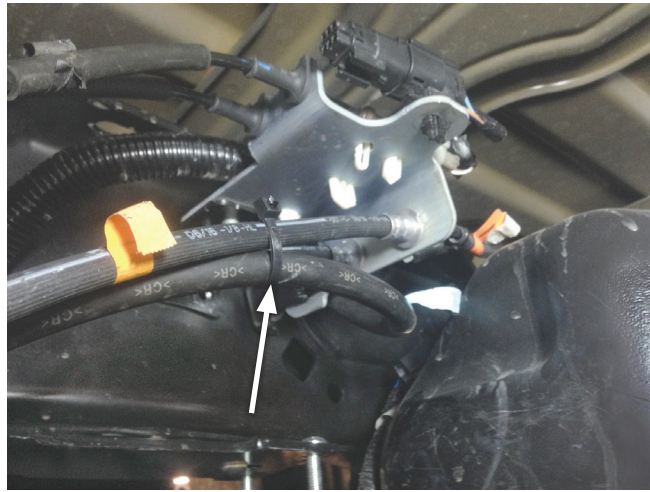

Fig. 38

12. Relocate the left ABS harness by securing the lower portion of the left ABS harness to the rubber brake line cover using zip tie (EE) (Fig. 39).

13. Secure the upper portion of the left ABS harness to the previously bent bracket using (1) 90-degree treemount (M) (Fig. 40).

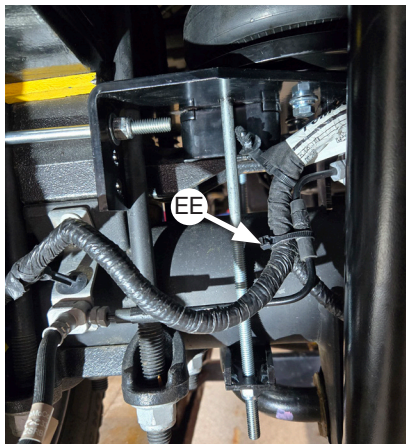

Fig. 39

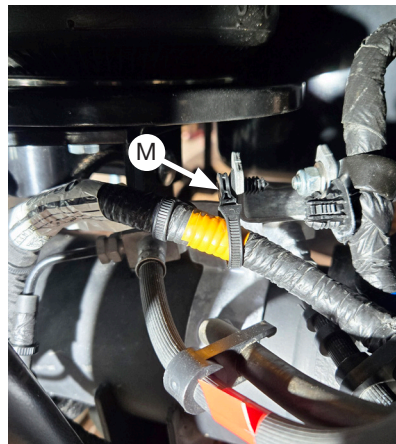
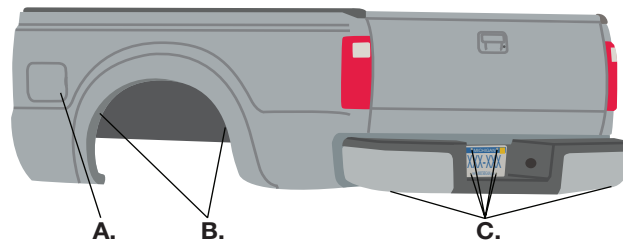

Fig. 40

Install the Air Lines

1. Choose the locations for the Schrader valves and drill a 5/16" (8mm) hole, if necessary.



A. Inside fuel tank filler door
 B. Inside rear wheel wells
 C. License plate or rear bumper area



CAUTION

KEEP AT LEAST 6" (152MM) OF CLEARANCE BETWEEN ALL AIR LINES AND THE EXHAUST SYSTEM. AVOID SHARP BENDS AND EDGES.

2. Make clean, square cuts with a razor blade or hose cutter when cutting the air line (AA). Do not use scissors or wire cutters.

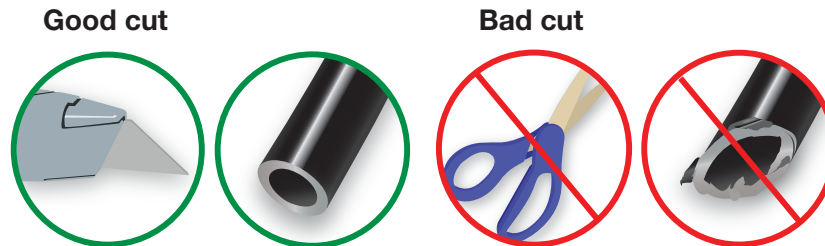

3. Use zip ties (BB) to secure the air line to fixed points along the chassis. Do not pinch or kink the air line. Leave at least 2" (51mm) of slack in the air line to allow for any movement that might pull on the air line. The minimum bend radius for the air line is 1" (25mm).
4. Install the Schrader valve in the chosen location.

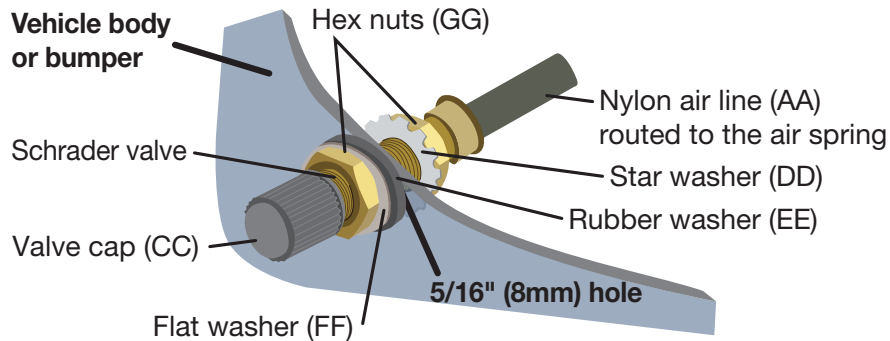

INSTALL THE HEAT SHIELD

1. Attach the metal heat shield to the exhaust pipe or exhaust resonator using the hose clamps. Slide the air line thermal sleeve over the air line and place it where the air line is closest to the exhaust.

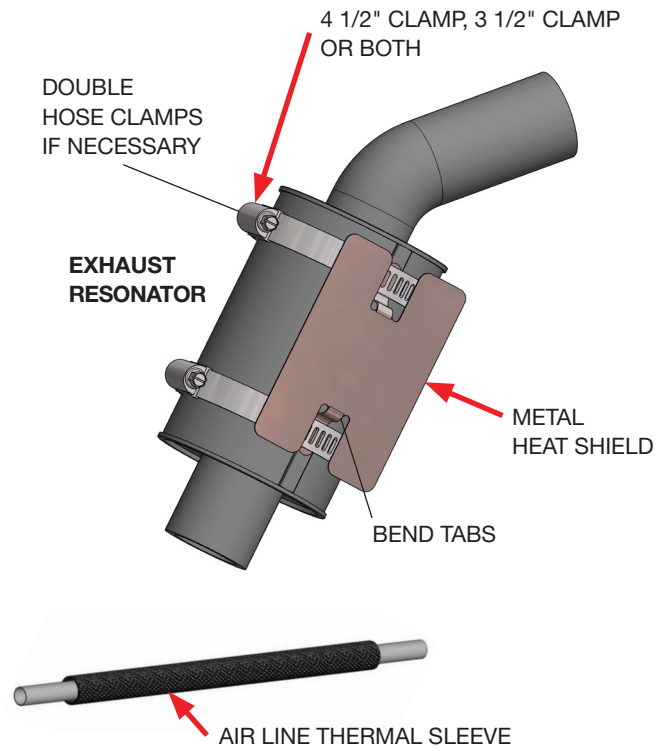
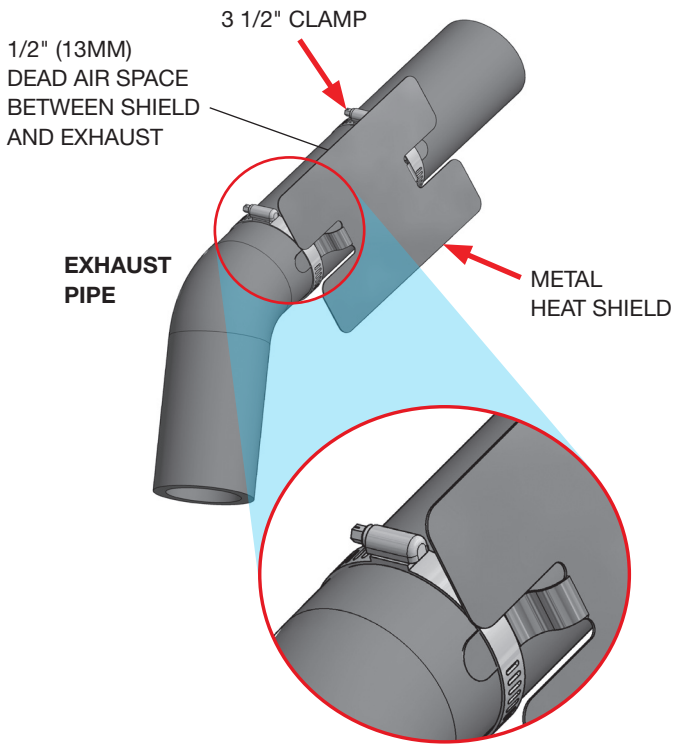

Finished Installation

The images show the finished installation of both sides for F250 & F350 SRW applications.

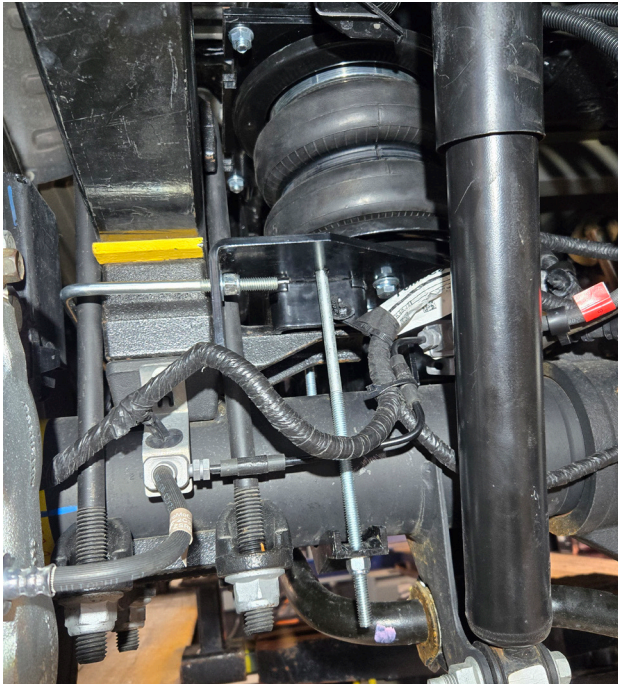

Driver's (left) side installation from the rear



Driver's (left) side installation from the middle



Passenger's (right) side installation from the rear



Passenger's (right) side installation from the middle

Congratulations!

You are now the proud owner of an Air Lift air suspension system. Enjoy!

Before Operating

INSTALLATION CHECKLIST

- Clearance test** — Inflate the air springs to 40-60 PSI (2.8-4.1BAR) and make sure there is at least 1/2" (13mm) clearance from anything that might rub against each air spring. Be sure to check the tire, brakes, frame, shock absorbers and brake cables.
- Leak test before road test** — Inflate the air springs to 40-60 PSI (2.8-4.1BAR) and check all connections for leaks. All leaks must be eliminated before the vehicle is road-tested.
- Heat test** — Be sure there is sufficient clearance from heat sources, at least 6" (152mm) for air springs and air lines. If a heat shield was included in the kit, install it. If there is no heat shield, but one is required, call Air Lift customer service at (800) 248-0892.
- Fastener test** — After 500 miles (800km), recheck all bolts for proper torque.
- Road test** — The vehicle should be road-tested after the initial tests. Inflate the air springs to recommended driving pressures. Drive the vehicle 10 miles (16km) and recheck for clearance, loose fasteners and air leaks.
- Operating instructions** — If professionally installed, the installer should review the operating instructions with the owner. Be sure to provide the owner with all of the paperwork that came with the kit.

MAINTENANCE AND USE GUIDELINES

1. Check air pressure weekly.
2. Always maintain normal ride height. Never inflate beyond 100 PSI (7BAR).
3. If the system develops an air leak, use a soapy water solution to check all air line connections and the inflation valve core before deflating and removing the air spring.
4. Upon successful completion of the installation, follow these pressure requirements for the air springs.



**Minimum Recommended
Air Pressure**



Maximum Air Pressure



CAUTION

FOR SAFETY AND TO PREVENT POSSIBLE DAMAGE TO THE VEHICLE, DO NOT EXCEED MAXIMUM GROSS VEHICLE WEIGHT RATING (GVWR) OR PAYLOAD RATING, AS INDICATED BY THE VEHICLE MANUFACTURER.

ALTHOUGH THE AIR SPRINGS ARE RATED AT A MAXIMUM INFLATION PRESSURE OF 100 PSI (7BAR), THE AIR PRESSURE ACTUALLY NEEDED IS DEPENDENT ON LOAD AND GROSS VEHICLE WEIGHT RATING.

Limited Warranty and Return Policy

Air Lift Company provides a Limited Lifetime Warranty* to the original purchaser of its load support products, from the date of original purchase, that the products will be free from defects in workmanship and materials when used on cars and trucks as specified by Air Lift Company and under normal operating conditions, subject to the requirements and exclusions set forth in the full Limited Warranty and Return Policy.

*Full Limited Warranty and Return Policy are available at www.airliftcompany.com/warranty and are subject to change.

WARRANTY REGISTRATION & CLAIMS

- To register your warranty, please visit <https://www.airliftcompany.com/support/warranty/register/>
- To submit a warranty claim, please visit <https://www.airliftcompany.com/support/warranty/submit-claim/>



Thank you for purchasing Air Lift Products!

Need Help?

Contact Air Lift Company Customer Service at (800) 248-0892
or email service@airliftcompany.com.

For calls outside the U.S. or Canada, dial +1 (517) 322-2144.



MADE IN USA
WITH GLOBAL
COMPONENTS

Air Lift Company • 2727 Snow Road • Lansing, MI 48917 or P.O. Box 80167 • Lansing, MI 48908-0167

Air Lift Company reserves the right to make changes and improvements to its products and publications at any time.
For the latest version of this manual, contact Air Lift Company at (800) 248-0892 or visit airliftcompany.com.