



AUTOMOTIVE PRODUCTS, INC.

# INSTALLATION INSTRUCTIONS

APPLICATION: E-SERIES BULL BAR  
2015 TAHOE / SUBURBAN / YUKON / YUKON XL  
APP PART # 31-5130

ITEM	QUANTITY	DESCRIPTION	TOOLS NEEDED
1	1	BULL BAR ASSEMBLY	RATCHET
2	1	DRIVER SIDE MOUNTING BRACKET	UTILITY KNIFE
3	1	PASSENGER SIDE MOUNTING BRACKET	18MM SOCKET
4	2	12-1.75MM DOUBLE BOLT PLATE	15MM SOCKET
5	2	12-1.75MM SINGLE BOLT PLATE	WRENCH SET
6	4	M10 CUP WASHER (STAINLESS)	
7	6	M12 FLANGE NUT (YELLOW ZINC)	
8	4	M10 BUTTON HEAD SCREW (STAINLESS)	
9	4	M10 FLANGE NUT (STAINLESS)	

ANTI-SEIZE LUBRICANT MUST BE USED ON ALL STAINLESS STEEL FASTENERS TO PREVENT THREAD DAMAGE AND GALLING .

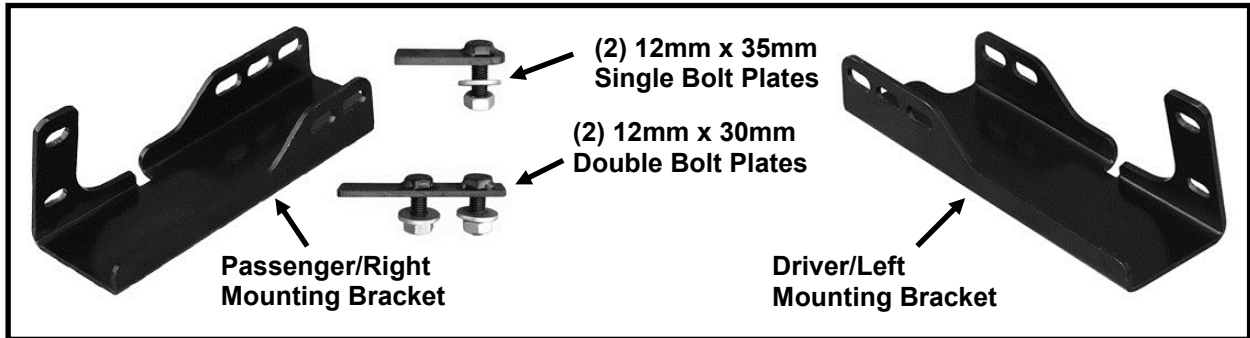

### PROCEDURE:

**REMOVE CONTENTS FROM BOX AND VERIFY ALL PARTS ARE PRESENT. READ INSTRUCTIONS CAREFULLY. CUTTING MAY BE REQUIRED. INSTALLATION MAY INTERFERE WITH FRONT MOUNTED PARKING SENSORS. NOTE:** It may be necessary to remove/relocate front license plate and license plate bracket. It is not required, but strongly recommended. If local/state law requires a front license plate, license plate relocation kit is available.

1. Start installation from under the front of the vehicle. Determine if the vehicle is equipped with tow hooks. **IMPORTANT:** Tow hooks cannot be reinstalled with the Bull Bar.  
**Tow Hook equipped vehicles:**



Westin Automotive Products, Inc.  
320 Covina Blvd  
San Dimas, Ca. 91773

Thank You for choosing Westin products  
For Additional installation assistance  
please call

- a. Remove the factory tow hook from the end of each frame channel, **(Figure 1)**. Skip to **Step 2** if tow hooks were accessible and have been removed. **NOTE:** The driver side tow hook on some newer models may be difficult to remove and assistance is highly recommended on these models. The following info only applies to the newer GM models.
    - i. **Tow hook removal-option 1:** Remove the hex bolts securing the driver side of the bumper to the bracket. Use a short pry bar or large screwdriver to move the tab on the bumper bracket up and away to clear the hex bolt and slide it out past the bumper bracket, **(Figures 2A, 2B)**.
    - ii. **Option 2:** Remove plastic radiator grille. Loosen and/or completely remove the front bumper to remove the long hex bolt in the driver side tow hook, **(Figure 2B)**.
  - b. Reattach the bumper after both tow hooks have been removed and the openings have been checked for Bracket clearance. Tighten all factory bumper hardware at this time.
  - c. Proceed to **Step 2**.
- Vehicles without tow hooks:**
- a. Cut out the indented area in both sides of the plastic bumper insert to clear the Brackets as pictured, **(Figures 3 & 4)**. **IMPORTANT:** Make several small cuts for best fit. Do not cut through the top edge of the panel. **NOTE:** On some newer models, the plastic panel is held in place with several small screws. The screws at the top corners are difficult to reach and remove without damaging the cover with the bumper in place. If you prefer to remove the panel to cut out the openings, it may be necessary or easier to remove the plastic grille then the steel bumper assembly with the plastic panel attached to access all of the small screws and clips.
  - b. Reattach the bumper and/or bumper insert, (if removed), and grille once openings have been cut out and checked for clearance. Tighten all factory bumper hardware at this time.
2. Select the driver side Mounting Bracket. Insert the Bracket through the opening in the bumper, **(Figure 5)**. Trim the plastic as required to clear the Brackets.
  3. Line up the holes in the Bracket with the holes in the end of the frame channel for the tow hook. Select (1) 12mm Double Bolt Plate, **(Figure 6A)**. Insert the Bolt Plate into the end of the frame, through the (2) holes in the side of the frame and out through the Bracket, **(Figures 5, 6B & 6C)**. Secure the Bracket to the Bolt Plate with (2) 12mm Flange Nuts, **(Figure 6C)**. Snug but do not fully tighten hardware at this time.
  4. Repeat **Step 3** to install the 12mm x 35mm Single Bolt Plate, **(Figure 7A)**, into the remaining hole in the other side of the frame channel and Bracket, **(Figures 5, 7B & 7C)**.
  5. **IMPORTANT:** The Brackets are designed with (2) mounting positions to fit multiple models and model years. Most Silverado/Sierra models will use the “back” mounting position with the Brackets pushed in to install the Bull Bar closer to the bumper, **(Figure 8A)**. Tahoe, Yukon and Suburban models may require the forward mounting position to move the Bull Bar forward or to provide more clearance for accessory lights, **(Figure 8B)**.
  6. Repeat **Steps 2 - 5** to install the passenger side Mounting Bracket.
  7. With assistance, hold the Bull Bar up in position on the outside of the Mounting Brackets. Bolt the Bull Bar to the Brackets with (4) 10mm x 30mm Button Head Screws, (8) 10mm Cup Washers and (4) 10mm Flange Nuts, **(Figure 9)**. Do not tighten hardware at this time.



Westin Automotive Products, Inc.  
320 Covina Blvd  
San Dimas, Ca. 91773

Thank You for choosing Westin products  
For Additional installation assistance  
please call

8. Check the Bull Bar alignment with the vehicle and for clearance between the Bull Bar and the bumper. If Bull Bar is too close to or touching bumper, remove the Bull Bar and reinstall the Brackets in the "forward" position away from the bumper. Adjust as required then fully tighten all hardware at this time.
9. Do periodic inspections to the installation to make sure that all hardware is secure and tight.

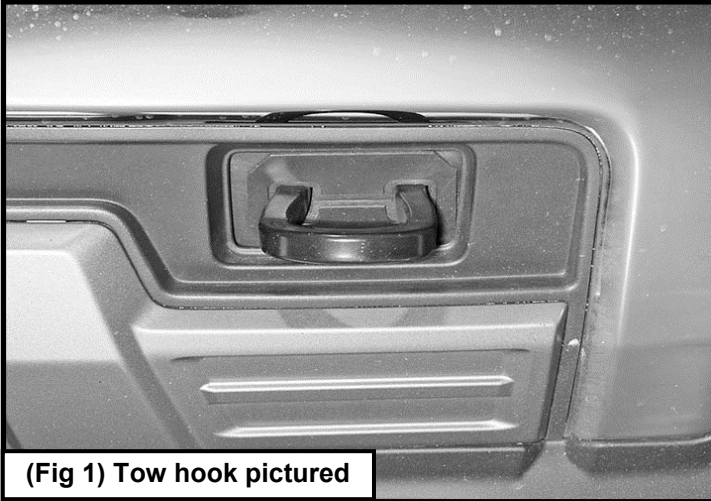

(Fig 1) Tow hook pictured

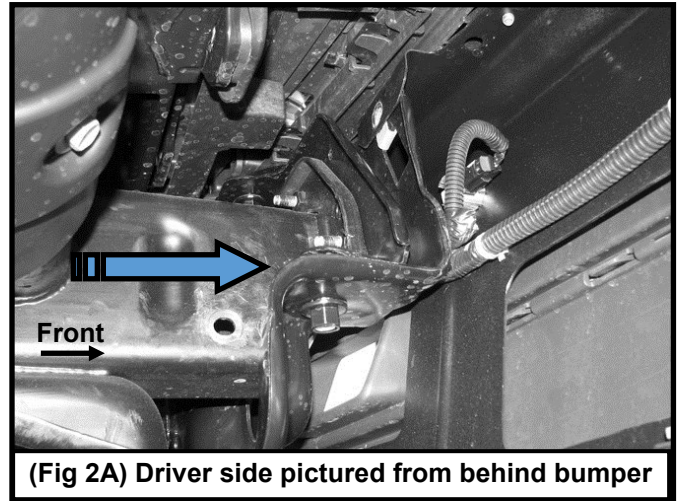

(Fig 2A) Driver side pictured from behind bumper

Remove the bolts securing the driver side of the bumper to the bumper bracket. Use a large screwdriver or pry bar to move the mounting tab up enough to get the long bolt through the tow hook out of the end of the frame

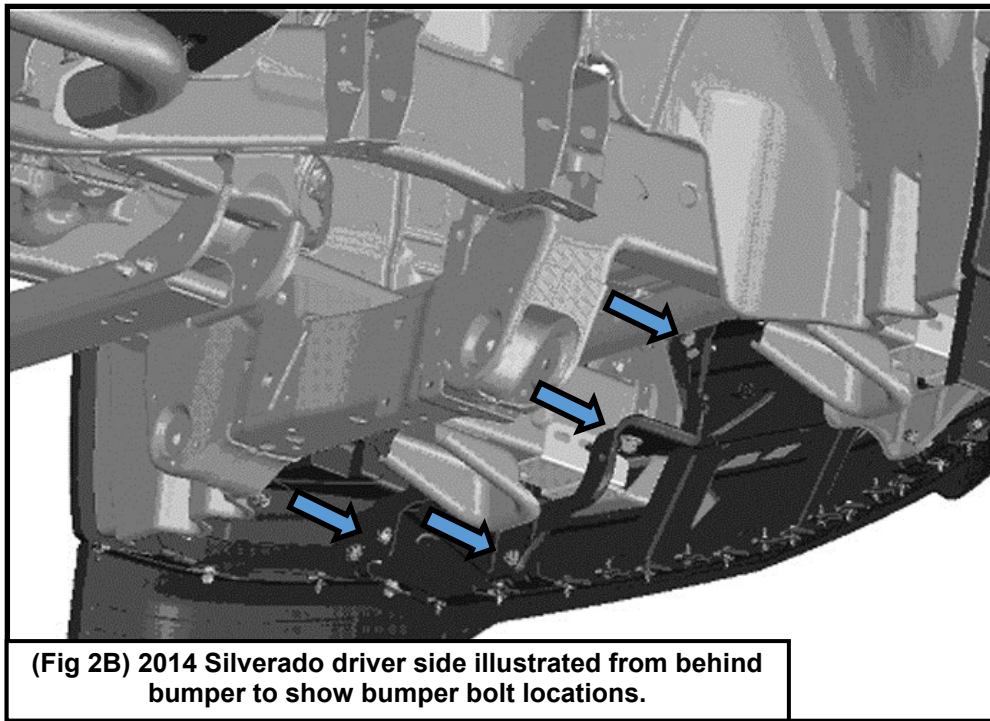

(Fig 2B) 2014 Silverado driver side illustrated from behind bumper to show bumper bolt locations.



Westin Automotive Products, Inc.  
320 Covina Blvd  
San Dimas, Ca. 91773

Thank You for choosing Westin products  
For Additional installation assistance  
please call

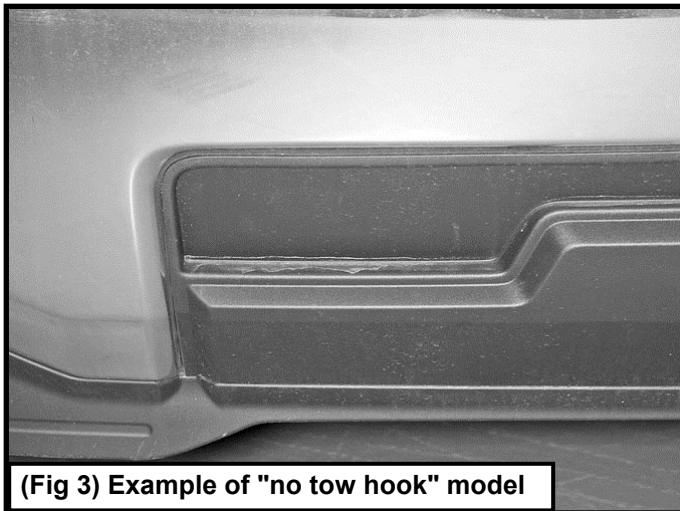

(Fig 3) Example of "no tow hook" model

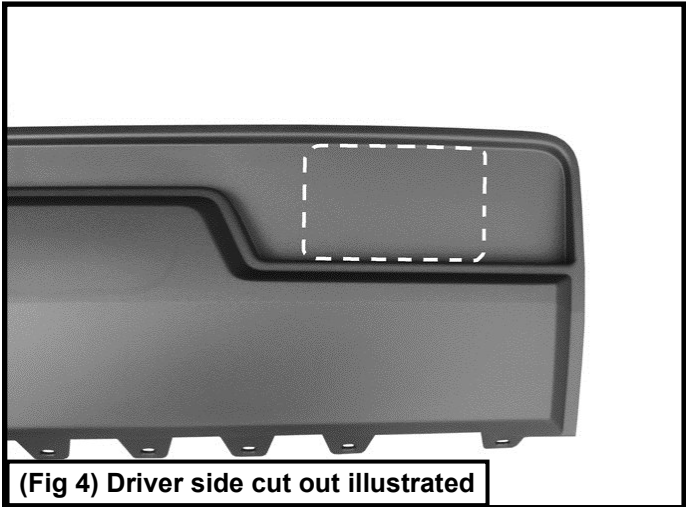

(Fig 4) Driver side cut out illustrated

Mounting holes in end of frame

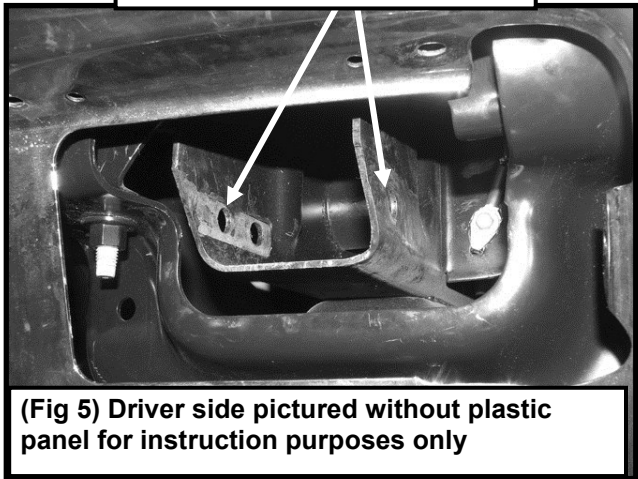

(Fig 5) Driver side pictured without plastic panel for instruction purposes only

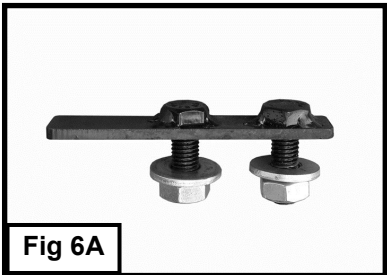
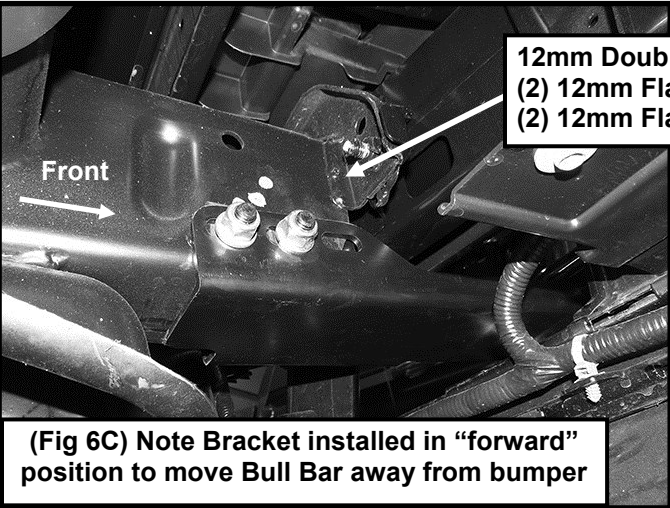
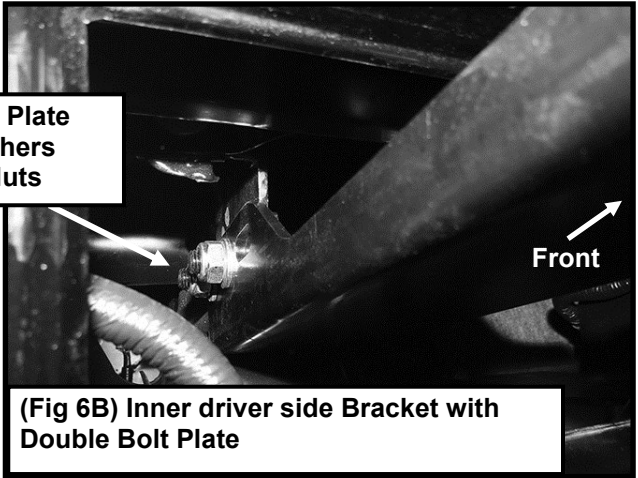

Fig 6A



12mm Double Bolt Plate  
 (2) 12mm Flat Washers  
 (2) 12mm Flange Nuts

(Fig 6C) Note Bracket installed in "forward" position to move Bull Bar away from bumper



(Fig 6B) Inner driver side Bracket with Double Bolt Plate



Westin Automotive Products, Inc.  
 320 Covina Blvd  
 San Dimas, Ca. 91773

Thank You for choosing Westin products  
 For Additional installation assistance  
 please call

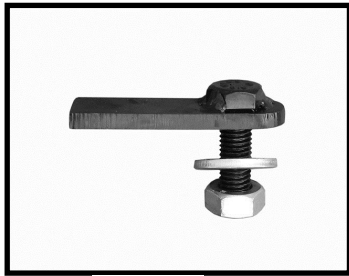
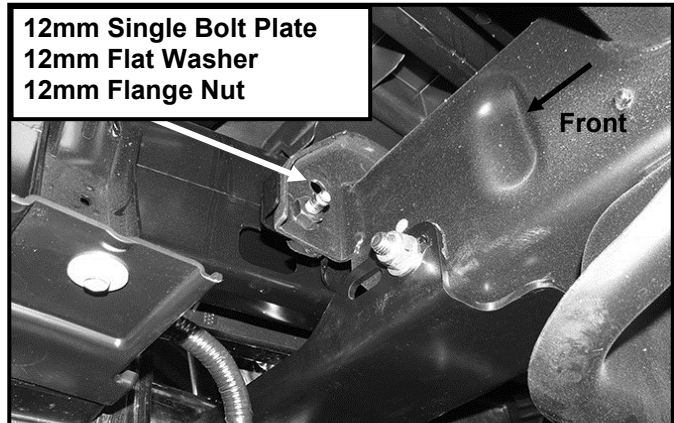

Fig 7A



12mm Single Bolt Plate  
12mm Flat Washer  
12mm Flange Nut

Front

(Fig 7B) Passenger Bracket installed in "forward" position to move Bull Bar away from bumper

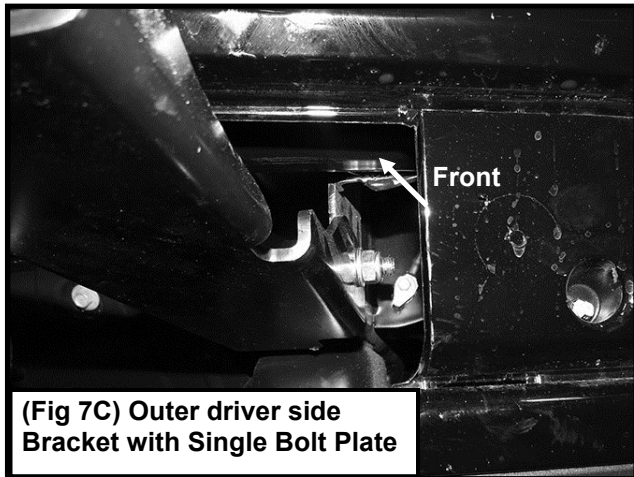

Front

(Fig 7C) Outer driver side Bracket with Single Bolt Plate

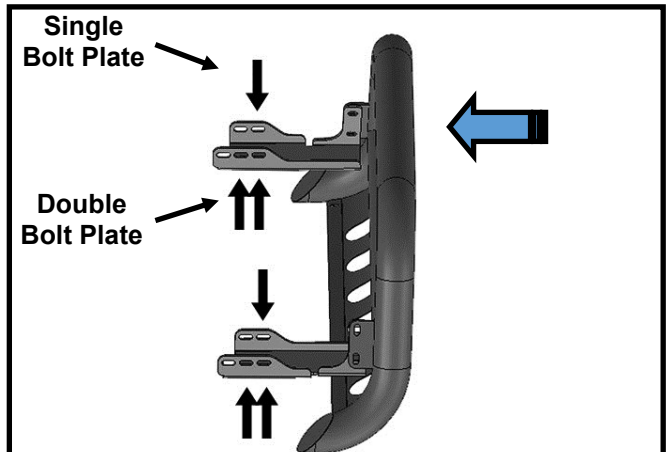

(Fig 8A) Typical Silverado/Sierra mounting position

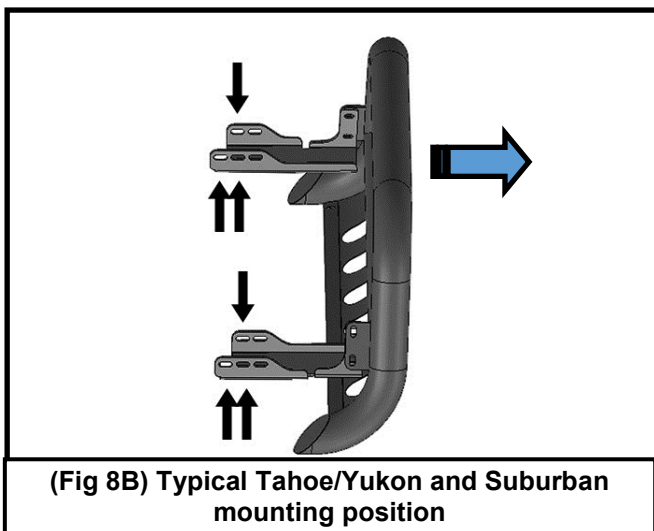

(Fig 8B) Typical Tahoe/Yukon and Suburban mounting position

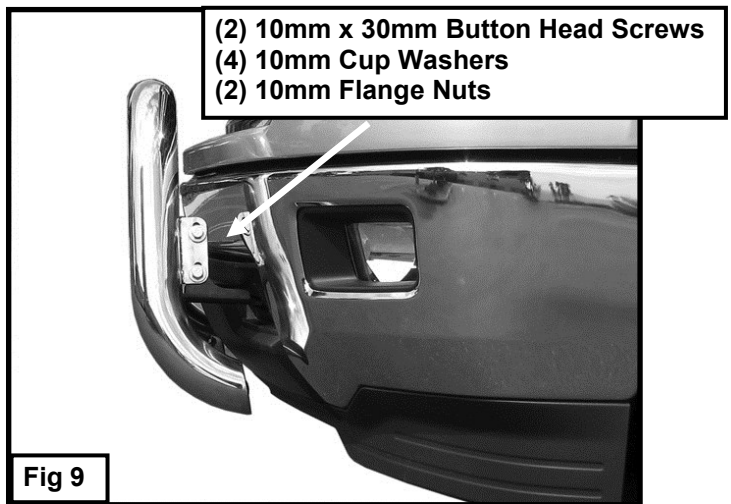

(2) 10mm x 30mm Button Head Screws  
(4) 10mm Cup Washers  
(2) 10mm Flange Nuts

Fig 9



Westin Automotive Products, Inc.  
320 Covina Blvd  
San Dimas, Ca. 91773

P.N.: 75-3095 REV A

ECO #: W14-0115

Thank You for choosing Westin products  
For Additional installation assistance  
please call

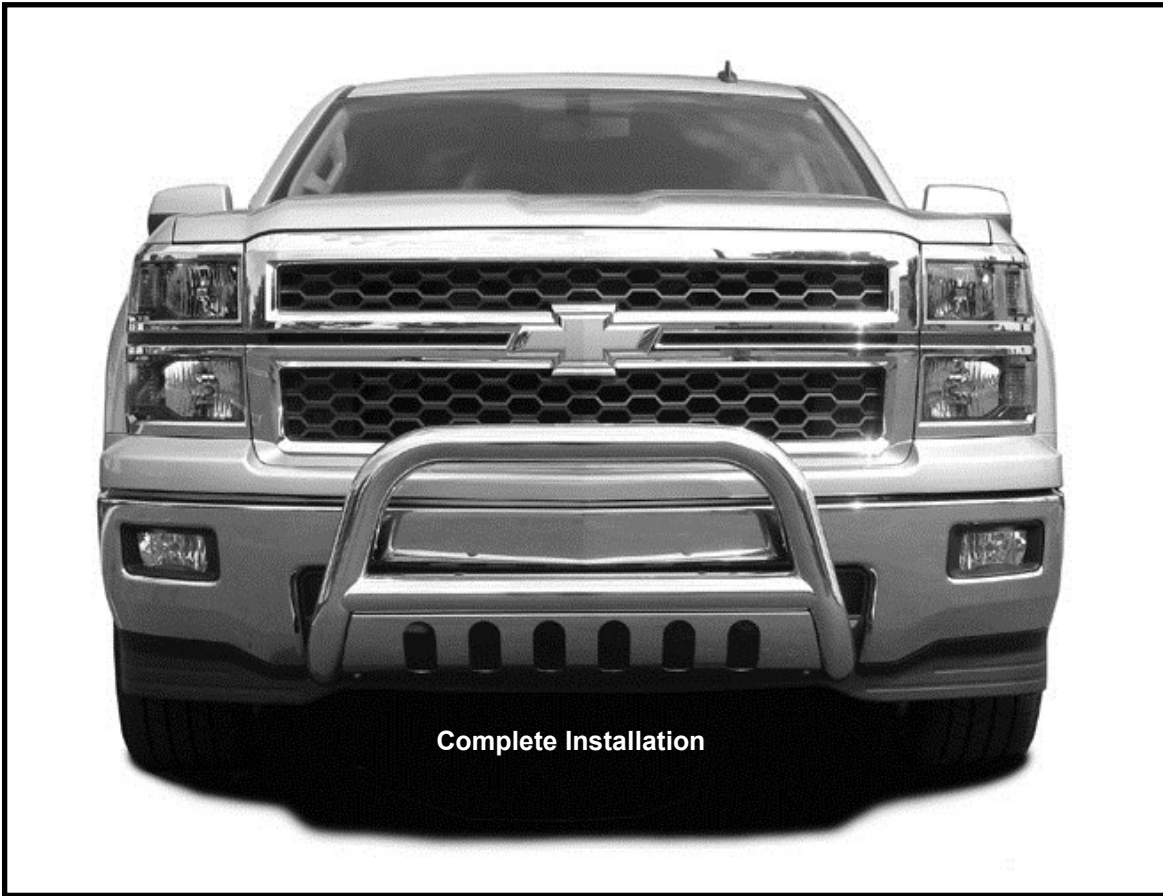

## CARE INSTRUCTIONS

- REGULAR WAXING IS RECOMMENDED. DO NOT USE ANY TYPE OF POLISH OR WAX THAT MAY CONTAIN ABRASIVES.
- STAINLESS STEEL PRODUCTS CAN BE CLEANED WITH MILD SOAP AND WATER. STAINLESS STEEL POLISH SHOULD BE USED TO POLISH SMALL SCRATCHES.
- GLOSS BLACK FINISHES SHOULD BE CLEANED WITH MILD SOAP AND WATER.



Westin Automotive Products, Inc.  
320 Covina Blvd  
San Dimas, Ca. 91773

P.N.: 75-3095 REV A

ECO #: W14-0115

6

Thank You for choosing Westin products  
For Additional installation assistance  
please call

DATE: 12/22/14