

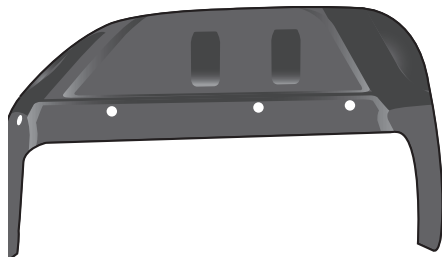

## WHEEL WELL LINERS GMC SIERRA



Driver Side Wheel Well (A)

### LIST OF CONTENTS:

- (A) 1 - Driver Side Wheel Well
- (B) 1 - Passenger Side Wheel Well

### LIK68 KIT:

- (C) 14 - Christmas Tree Fasteners
- (D) 14 - Rubber Washers

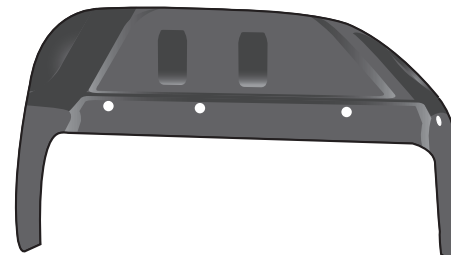
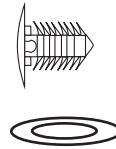

Passenger Side Wheel Well (B)

### TOOLS REQUIRED:

- T-10 Torx bit / driver used in step 3 and 9.

## INSTALLATION INSTRUCTIONS

1

**PLEASE READ INSTRUCTIONS CAREFULLY BEFORE STARTING THE INSTALLATION.**  
One person can perform the installation.

2

### VEHICLE PREPARATION:

It is important that all areas where the wheel wells mount are clean and free of debris prior to installing.

3

**Note:** If your truck model came **without** the optional wheel well liners and fasteners please skip to step 4.

**Note:** If your truck model came **with** the optional wheel well liners and fasteners, remove the (7) factory fasteners using a T-10 Torx bit / driver holding the factory liners in place.  
(Keep all factory fasteners).

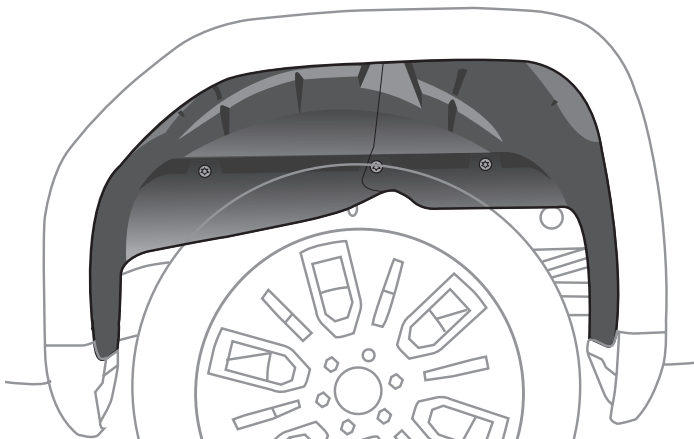

4

Start on the driver side by setting the driver side wheel well (A) marked as (DS) inside the inner panel of the truck's wheel well behind the tire.

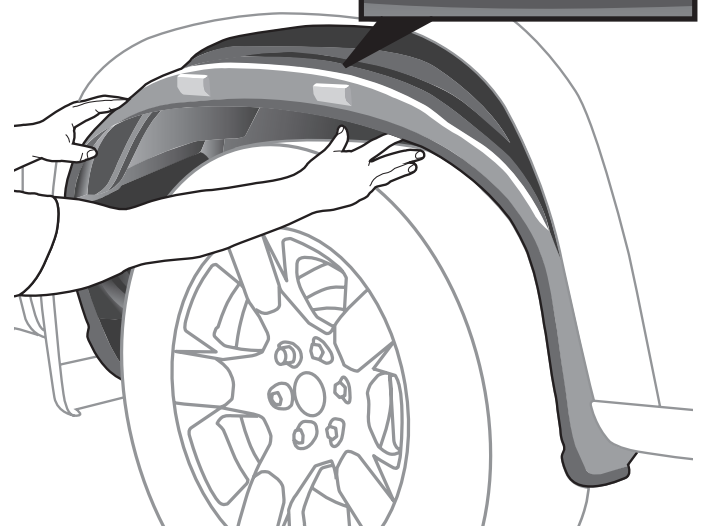



## WHEEL WELL LINERS 15-20 FORD F150

- 5** Tuck the lower cab part of the wheel well liner behind the metal lip of truck's fender. Also tuck it behind the factory rock guard.

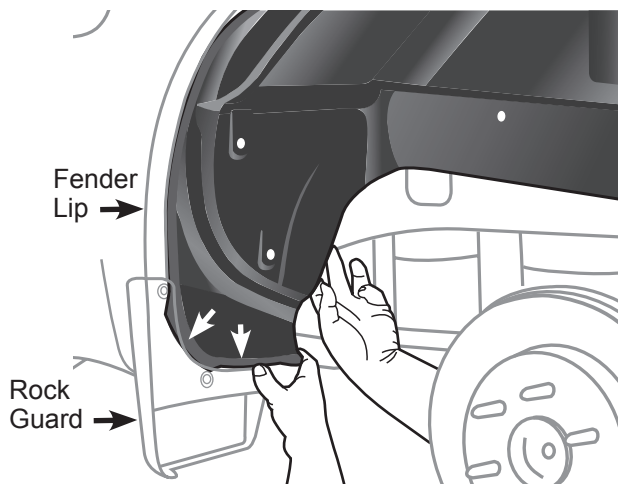

- 6** Tuck the lower tail part of the wheel well liner behind the metal lip of truck's fender. Also tuck it behind the factory rock guard.

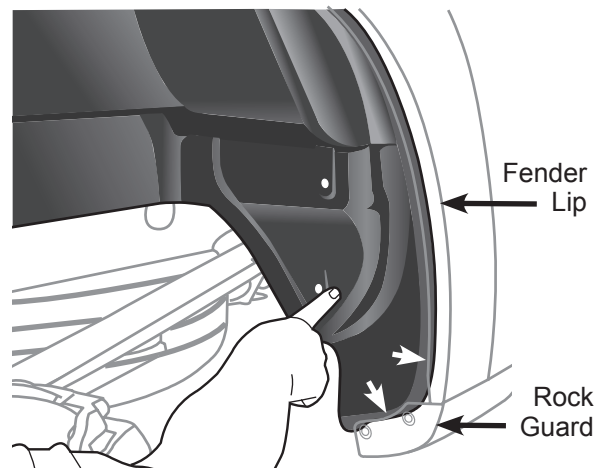

- 7** Tuck the upper part of the wheel well liner behind the rest of the metal lip of the truck's fender.

- 8** **Note:** If your truck model came **without** the optional wheel well liners and fasteners, use (7) of the Christmas tree fasteners (C) provided to install the liners.



OR

- 9** **Note:** If your truck model came **with** the optional wheel well liners and fasteners, re-install the (7) factory fasteners from step 3 along with (7) of the rubber washers (D) provided using a T-10 Torx bit / driver.

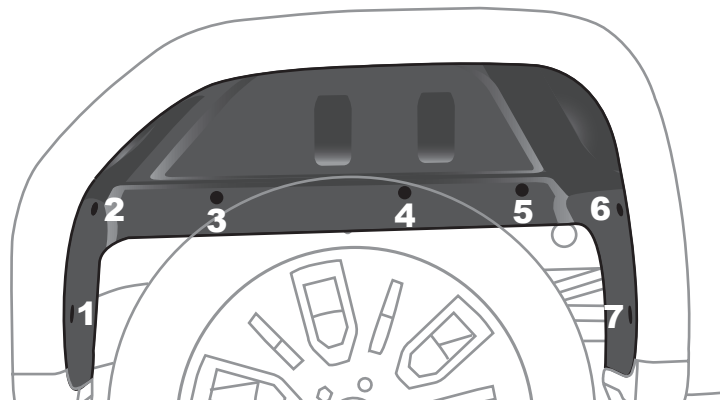
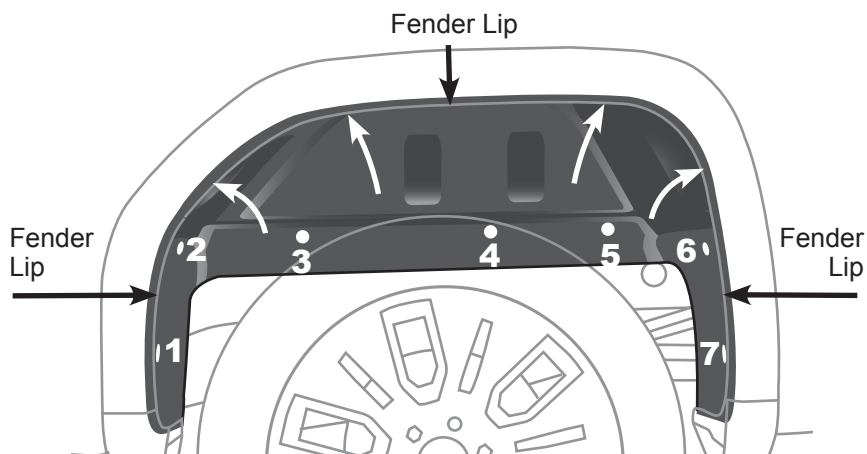

- 10** Repeat steps 3-9 on the passenger side when installing the passenger side wheel well (B).