



**2022-C Chev Silverado 1500 ZR2**  
**Nylon 5/8" Offset Mud Flap Set, Front**  
**Mounting Diagram & Instructions**  
**Kit# GCN209F**

**IMPORTANT:**

*Manufacturer is not responsible for negligent use of vehicle with mud flaps installed, including over-tightening of screws and bolts causing damage to vehicle or mud flaps.*

**TOOLS REQUIRED-**

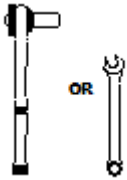

5/16" Open Wrench or Socket Wrench

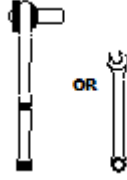

7/16" Open Wrench or Socket Wrench

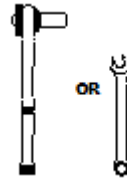

10mm Open Wrench or Socket Wrench

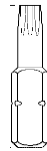

T15 Torx Bit

**FLAPS**

(1) Upper Mount Front, DS

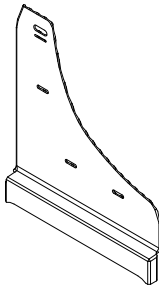

(1) Upper Mount Front, PS

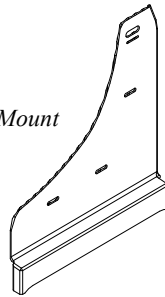

(2) Rubber Flap Universal 12" x 8-3/4"

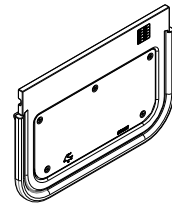

Please note: There will be a plastic piece in the upper mount channel. Please remove and discard.

(1) Nylon Cap Driver Side Part #080642 (Assembled on Upper Mount)

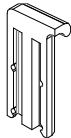

(1) Nylon Cap Passenger Side Part #080643 (Assembled on Upper Mount)

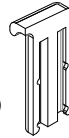

**PARTS BAG # 770873**

a) (2) Capscrew, SS 1/4"-20UNC x 3/8", oxidized Part #014069



b) (6) Bolt, Hex Flange, SS M 4.2 x 1", Black Part # 016041

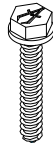

c) (2) Washer, Flat 0.281" x 1", 18g, SS, oxidized Part #018069



d) (6) Washer, Flat 0.203" x 1", 18g, SS, oxidized Part #018070



e) (1) Mount Clip, DS w/Clinch Nut Part # 767068

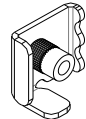

f) (1) Mount Clip, PS w/Clinch Nut Part #767069

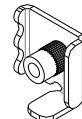

g) (2) J-Clip 1" x 1.75" Part #770273

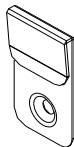

## ASSEMBLY OF NYLON MUD FLAPS:

1. Remove locking caps from nylon upper mounts and set aside for reinstallation.
2. Remove and discard the plastic strip inside the track at the bottom of the nylon upper mount.
3. Slide rubber guide into track of nylon upper mount.
4. Reinstall locking cap(s) on bottom of nylon upper mount. Note: To fully lock this cap into place, you should hear two clicks. When the cap is fully locked, it will be even with the offset part of the upper mount.
5. Repeat Procedure for second mud flap.

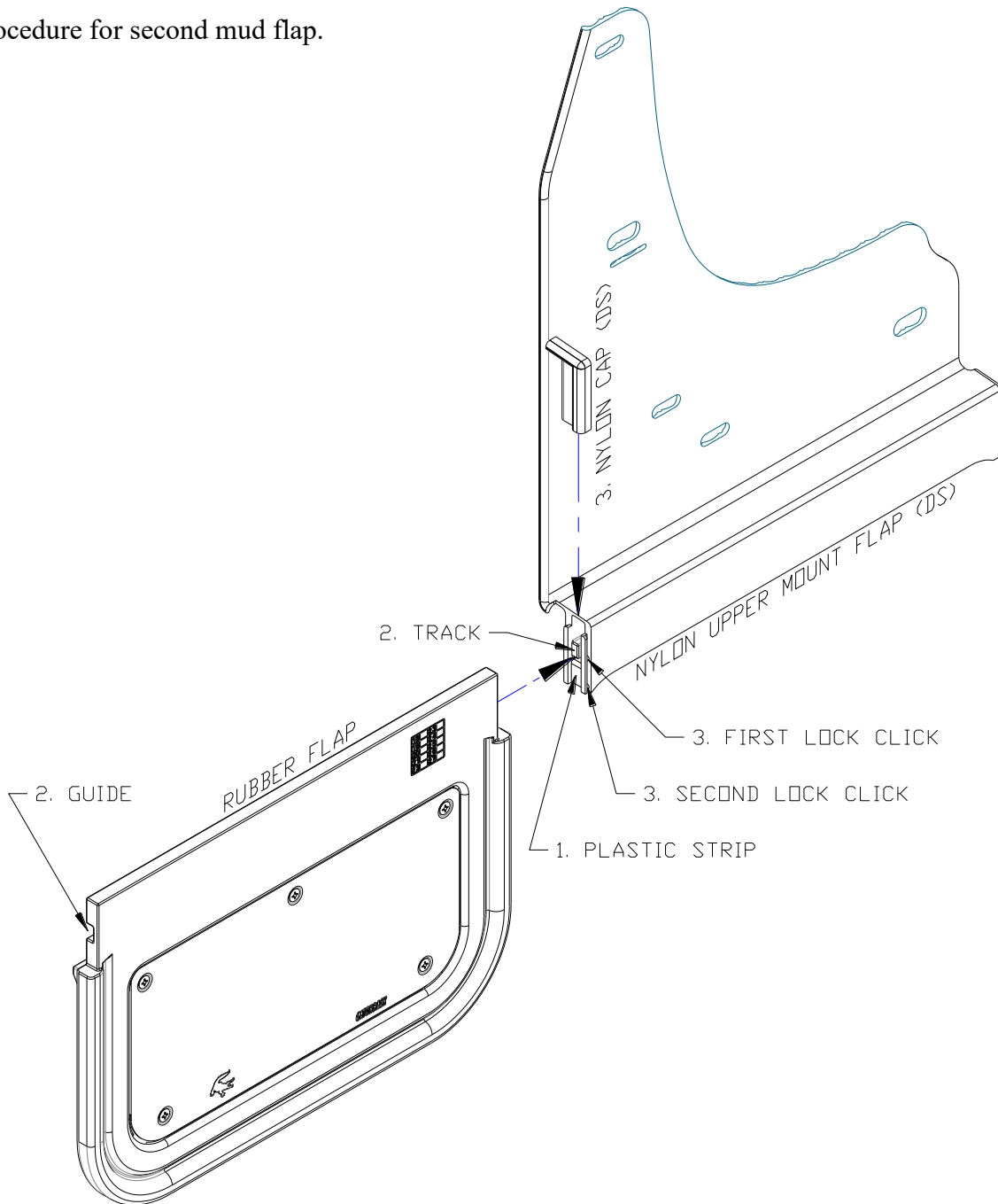

Please check out our YouTube channel to see an install video for this application



## INSTALLATION *(For ease of installation it is suggested that the wheel be removed)*

1. Before you install your Mud Flap Set, see the diagram and parts list for all necessary parts. Start on the driver's side.
2. Remove 2 factory screws from holes #1 & #2.
3. Install mount clip (e) on hole #3 using supplied capscrew (a) and flat washer (c).
4. Install mud flap hole #5 to factory hole #2 using a sheet metal screw (b) and flat washer (d).
5. Install mud flap hole #4 to factory hole #1 using a sheet metal screw (b) and flat washer (d)
6. Hold the mud flap level and tight to the wheel well and with a marker, mark through hole #6 onto factory plastic molding.
7. Pull mud flap aside and drill a hole through the plastic molding using a 9/32" drill bit over the mark made in step 6.
8. Install J-Clip (g) over hole drilled in step 7. Ensure this is properly aligned by gently installing sheet metal screw (b) through the plastic molding and into the clip. Remove screw before proceeding to the next step.
9. Slide mount clip (e) behind the lip of the fender to secure.
10. Install mud flap hole #6 to J-clip (g) using a sheet metal screw (b) and flat washer (d)
11. Using a bubble level or other levelling tool, ensure that the mud flap is level. Tighten all fasteners.
12. Repeat on passenger side.

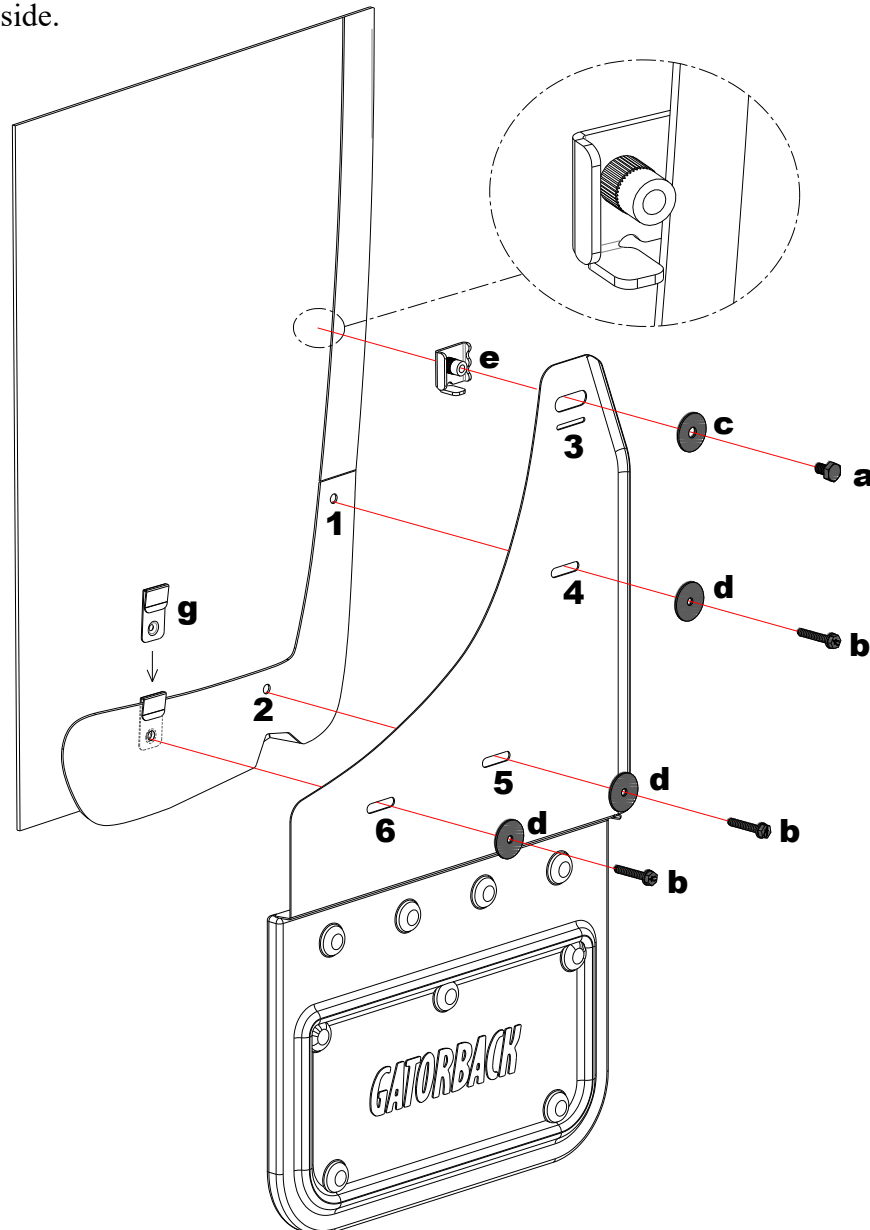

Please check out our YouTube channel to see an install video for this application.



# GATORBACK MUDFLAPS

## 2022-C Chev Silverado 1500 ZR2 Nylon 5/8" Offset Mud Flap Set, Rear Mounting Diagram & Instructions Kit# GCN209R

### IMPORTANT:

Manufacturer is not responsible for negligent use of vehicle with mud flaps installed, including over-tightening of screws and bolts causing damage to vehicle or mud flaps.

### TOOLS REQUIRED-

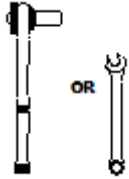

5/16" Open Wrench or  
Socket Wrench

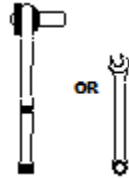

7/16" Open Wrench or  
Socket Wrench

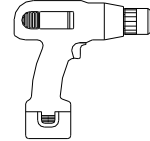

Electric or Rechargeable  
Drill



1/4" Drill  
Bit

### FLAPS

(1) Upper Mount  
Rear, DS

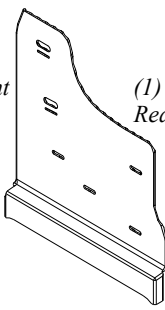

(1) Upper Mount  
Rear, PS

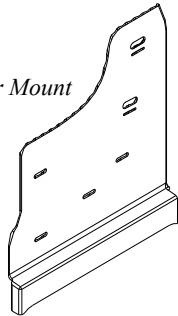

(1) Bracket  
Rear, DS  
Part #767066



(1) Bracket  
Rear, PS  
Part #767067

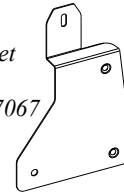

(2) Rubber  
Universal  
12" x 8-3/4"

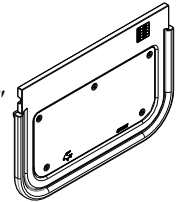

Please note: There will be a plastic piece in the upper mount channel. Please remove and discard.

(1) Nylon Cap  
Driver Side  
Part #080642  
(Assembled on Upper Mount)

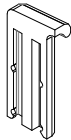

(1) Nylon Cap  
Passenger Side  
Part #080643  
(Assembled on Upper Mount)

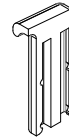

### PARTS BAG #769189

a) (4) Washer, Flat  
0.281" x 1", 18g, SS, oxid.  
Part #018069

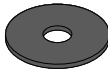

b) (8) Washer, Flat  
0.203" x 1", 18g, SS, oxid.  
Part #018070

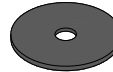

c) (4) Capscrew, SS  
1/4"-20UNC x 3/4"  
Part #014070

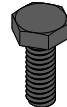

d) (8) Bolt, Hex Flange, SS  
M 4.2 x 1", Black  
Part # 016041

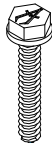

e) (2) Mount Clip, DS  
w/Clinch Nut  
Part # 767068

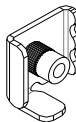

f) (2) Mount Clip, PS  
w/Clinch Nut  
Part #767069

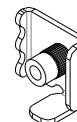

g) (2) Rad Grill Nut  
#8 Thread, Zinc Pltd  
Part # 016049

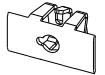

**Note:** Part #016049 is used only on vehicles without factory liner

## ASSEMBLY OF NYLON MUD FLAPS:

1. Remove locking caps from nylon upper mounts and set aside for reinstallation.
2. Remove and discard the plastic strip inside the track at the bottom of the nylon upper mount.
3. Slide rubber guide into track of nylon upper mount.
4. Reinstall locking cap(s) on bottom of nylon upper mount. Note: To fully lock this cap into place, you should hear two clicks. When the cap is fully locked, it will be even with the offset part of the upper mount.
5. Repeat Procedure for second mud flap.

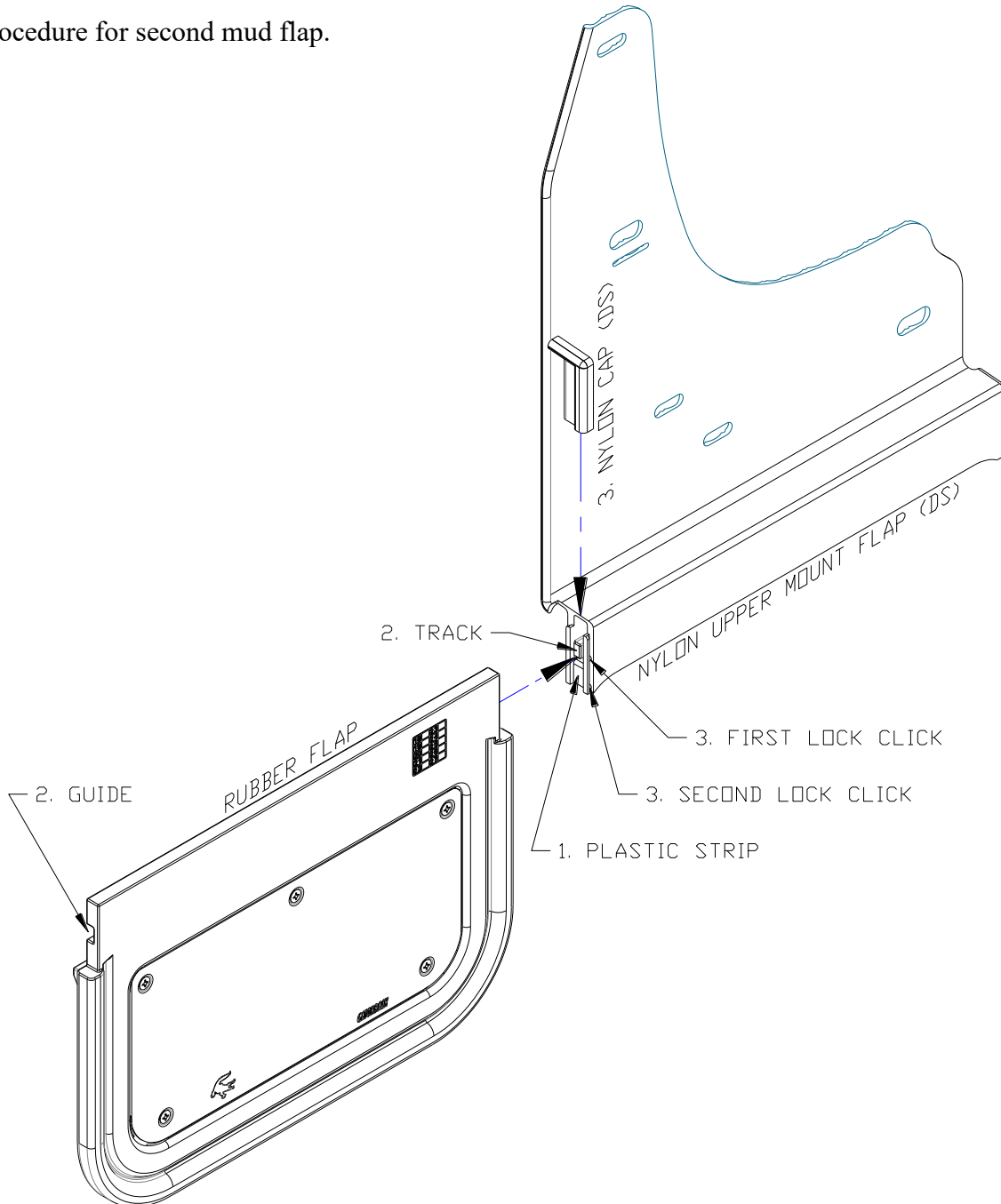

Please check out our YouTube channel to see an install video for this application



## INSTALLATION *(For ease of installation it is suggested that the wheel be removed)*

1. Before you install your Mud Flap Set, see the diagram and parts list for all necessary parts. Start on driver's side.
2. Remove factory screws from factory guard. \*Removal process may vary dependent on the factory guard style.\* If 3M tape has been used to install the factory guard, use alcohol on a microfiber cloth to remove.
3. For vehicles **with** liners, remove factory screw from hole #1.
4. For vehicles **without** liners, install clip (g) into hole #1 as shown in Diagram A-1.
5. Install mount clips (e) on holes #12 & #13 using supplied bolts (c) and washers (a) See Diagram A-2.
6. Loosely install the bracket through hole #4 into hole #1 using a previously removed factory screw. (For trucks without liners, reuse factory screw from hole #3.)
7. Loosely secure the mud flap through hole #8 to bracket hole #6 using supplied bolt (d) and oxidized washer (b).
8. Loosely install clips (e) behind fender lip.
9. Loosely secure mud flap hole #10 to the bracket hole #5 using supplied bolt (d) and oxidized flat washer (b).
10. Loosely install mud flap through hole #9 through bracket hole #7 to factory hole #2 using supplied bolt (d) and oxidized washer (b)
11. Loosely secure mud flap hole #11 to factory hole #3 using supplied bolt (d) and washer (b)
12. Using a bubble level or other levelling tool, ensure that the mud flap is level. Tighten all fasteners.
13. Repeat on passenger side.

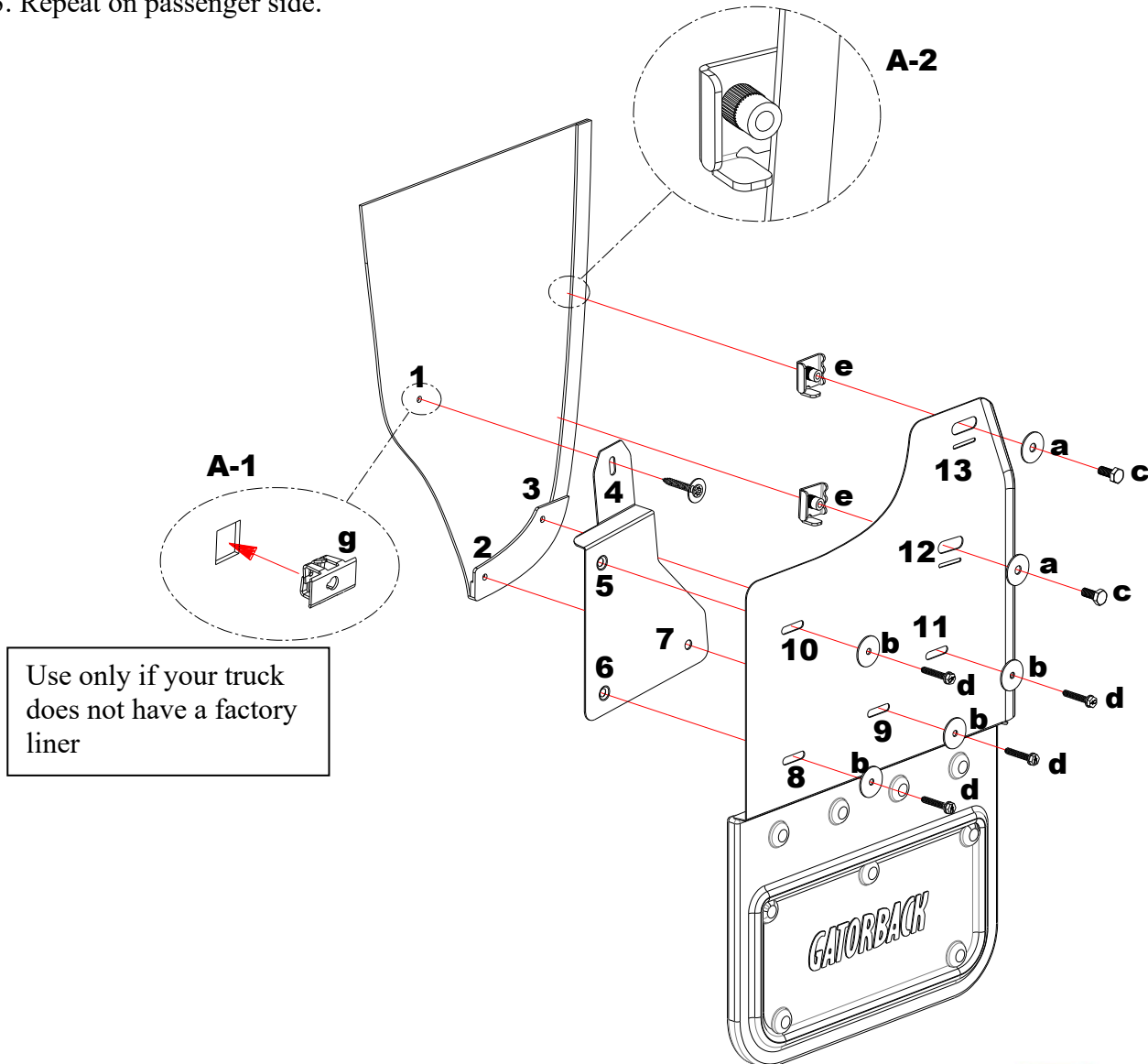

Please check out our YouTube channel to see an install video for this application.

