



# 23-C Sierra 1500 AT4X AEV Edition Nylon Mud Flap Set, 1.5" Offset, Front Mounting Diagram & Instructions Kit# GCN211F

**\*These Mud Flaps are Designed for the AEV Edition AT4X Only\***

**IMPORTANT:**

**Manufacturer is not responsible for negligent use of vehicle with mud flaps installed, including over-tightening of screws and bolts causing damage to vehicle or mud flaps.**



**TOOLS REQUIRED-**

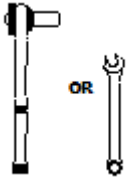

7/16" & 10mm Open Wrench or Socket Wrench

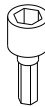

1/4", 7/16" & 10mm Socket Drivers

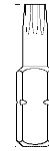

T15 Torx Bit

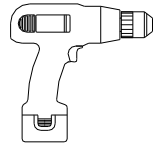

Electric or Rechargeable Drill

**FLAPS**

(1) Upper Mount Front, DS Part #770880

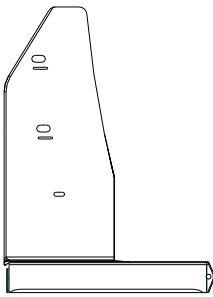

(1) Upper Mount Front, PS Part #770881

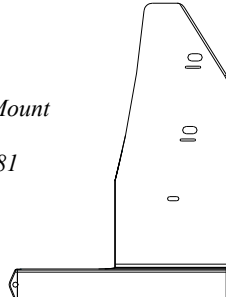

(2) Rubber Flap Universal 12" x 8-3/4"

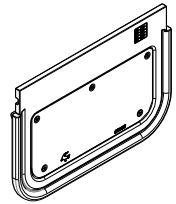

(1) Nylon Cap Driver Side Part #080642 (Assembled on Upper Mount)

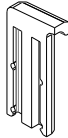

(1) Nylon Cap Passenger Side Part #080643 (Assembled on Upper Mount)

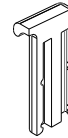

**PARTS BAG # 770878**

**a)** (4) Capscrew 1/4"-20 x 5/8" SS, ox. Part #014071



**b)** (2) Capscrew 1/4"-20 x 1.5" SS, blk ox. Part #014074

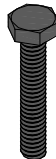

**c)** (2) Screw, Sheet Metal, Blk Ox. 1/4" Hex Washer Head, #8-18x1.25" Part # 016061



**d)** (4) Washer, Flat 0.281" x 1", SS, oxid Part #018069

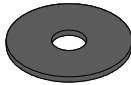

**e)** (2) Washer, Flat 0.203" x 1", SS, oxid. Part #018070

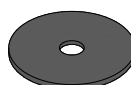

**f)** (2) Washer, Flat 0.281" x 0.781", SS Part #018088

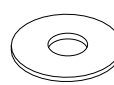

**g)** (2) Lock Washer 1/4" Helicoil, SS Part #024000



**h)** (2) Hex Nut 1/4"-20, SS Part #025000

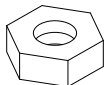

**i)** (4) Spacer Washer 7/16" x 1" x 1/4" Part #054091



**j)** (2) Mud Flap Clip Driver Side Part # 769312

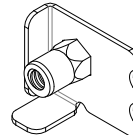

**k)** (2) Mud Flap Clip Passenger Side Part #769313

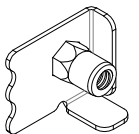

**l)** (1) Bracket Front, Drivers Part #770876

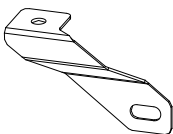

**m)** (1) Bracket Front, Passengers Part #770877

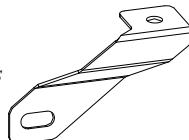

## ASSEMBLY OF NYLON MUD FLAPS:

1. Remove locking caps from nylon upper mounts and set aside for reinstallation.
2. Remove and discard the plastic strip inside the track at the bottom of the nylon upper mount.
3. Slide rubber guide into track of nylon upper mount.
4. Reinstall locking cap(s) on bottom of nylon upper mount.

**Note: To fully lock this cap into place, you should hear two clicks.** When the cap is fully locked, it will be even with the offset part of the upper mount.

5. Repeat Procedure for second mud flap.

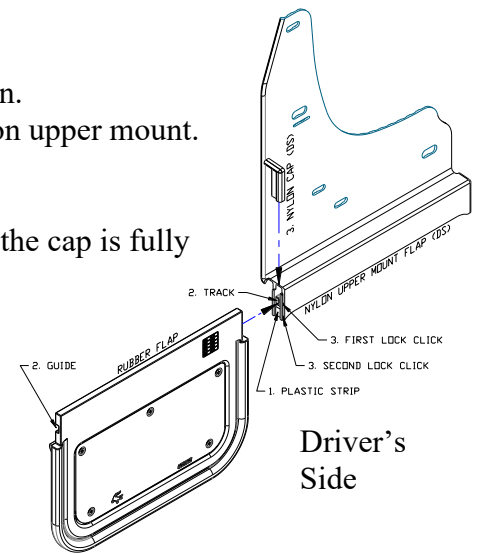

## MUD FLAPS:

1. Before you install your Mud Flap Set, see the parts list for all necessary parts. Start on the driver's side.
2. Remove the factory screw from the inner wheel well, and the factory screw from the bottom of the factory guard.
3. Using the factory screw removed in the previous step, secure the bracket to the bottom of the factory guard.
4. Loosely install mount clips (j) on mud flap holes #1 & #2 using a capscrew (a), flat washer (d), & spacer washer (i)
5. Install mud flap hole #3 to factory hole # using a sheet metal screw (c) and flat washer (e)
6. Slid mount clips (j) behind the fender lip and loosely secure.
7. Install mud flap hole #4 to bracket hole # using a capscrew (b) and secure using a flat washer (f), lock washer (g) and hex nut (h)
8. Using a bubble level or other levelling tool, ensure that the mud flap is level. Tighten fasteners.
9. Repeat procedure for passenger side.

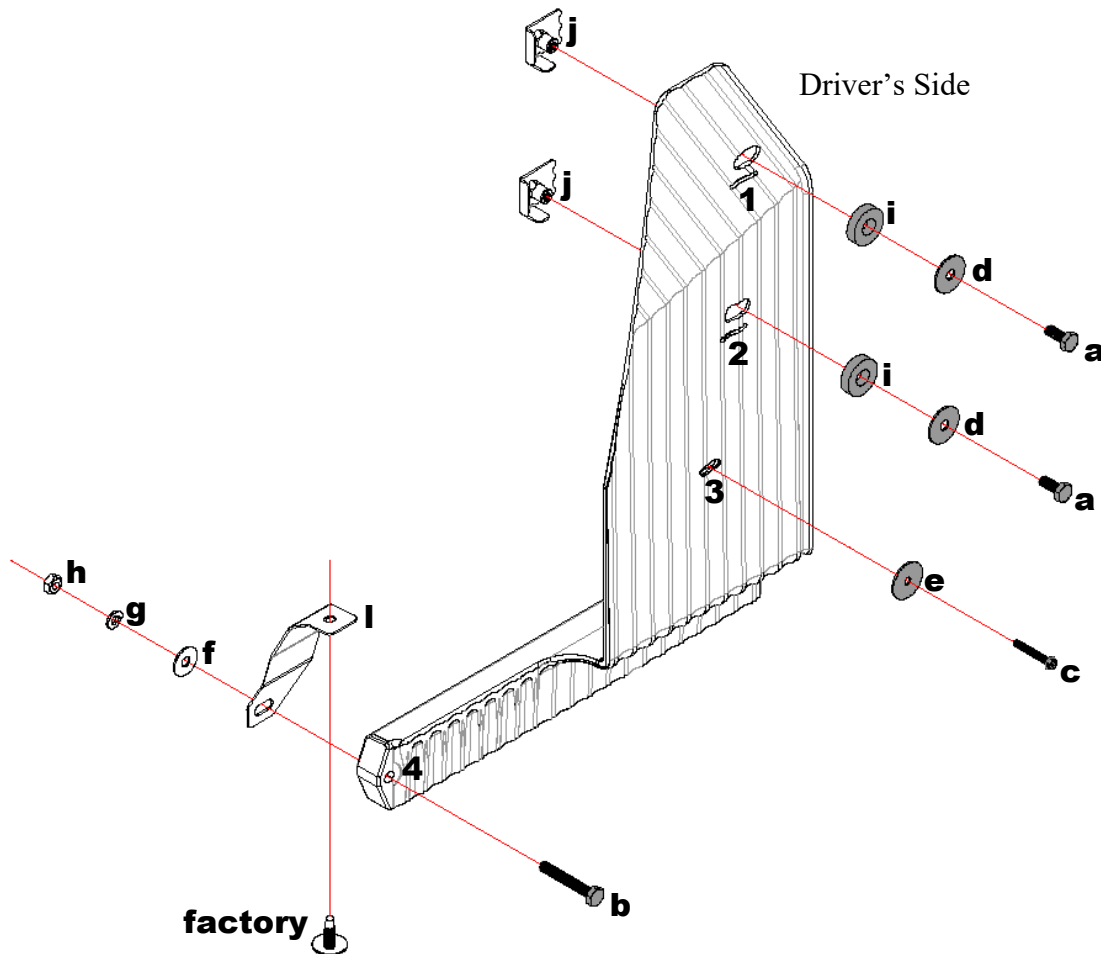

Please check out our YouTube channel to see an install video for this application.





**23-C Sierra 1500 AT4X AEV**  
**Nylon Mud Flap Set, 1.5" Offset, Rear**  
**Mounting Diagram & Instructions**  
**Kit# GCN211R**

**\*These Mud Flaps are Designed for the AEV Edition AT4X Only\***

**IMPORTANT:**

**Manufacturer is not responsible for negligent use of vehicle with mud flaps installed, including over-tightening of screws and bolts causing damage to vehicle or mud flaps.**



**TOOLS REQUIRED-**

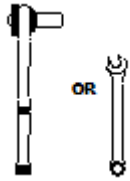

7/16" Open Wrench or  
Socket Wrench

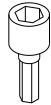

1/4" & 7/16" Socket Drivers



T15 Torx  
Bit

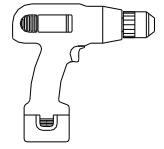

Electric or Rechargeable  
Drill

**FLAPS**

(1) Upper Mount  
Rear, DS  
Part #770882

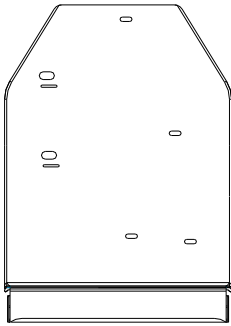

(1) Upper Mount  
Rear, PS  
Part #770883

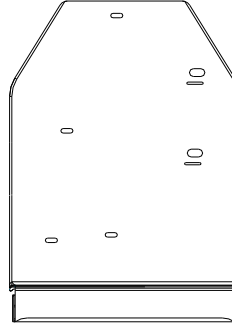

(2) Rubber Flap  
Universal  
12" x 8-3/4"

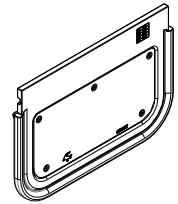

(1) Nylon Cap  
Driver Side  
Part #080642  
(Assembled on Upper Mount)

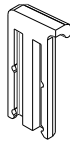

(1) Nylon Cap  
Passenger Side  
Part #080643  
(Assembled on Upper Mount)

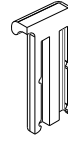

**PARTS BAG # 770879**

**a)** (4) Capscrew  
1/4"-20 x 5/8" SS, Blk. Ox.  
Part #014071

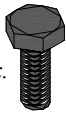

**b)** (6) Screw, Sheet Metal  
#8-18 x 1" SS Blk Ox.  
Part #016055



**c)** (2) Screw, Sheet Metal  
#8-18x1.5" SS, Blk Ox.  
Part # 016061



**d)** (4) Washer, Flat  
0.281" x 1", SS, oxid  
Part #018069

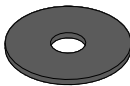

**e)** (10) Washer, Flat  
0.203" x 1", SS, Blk. Ox.  
Part #018070

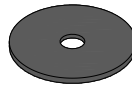

**f)** (2) Spacer, Nylon  
1/4" x 1/2" x 1/2"  
Part #054063



**g)** (4) Spacer Washer  
7/16" x 1" x 1/4"  
Part #054091

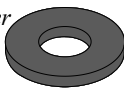

**h)** (2) Mud Flap Clip  
Driver Side  
Part # 769312

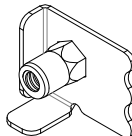

**i)** (2) Mud Flap Clip  
Passenger Side  
Part #769313

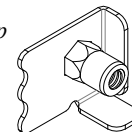

## ASSEMBLY OF NYLON MUD FLAPS:

1. Remove locking caps from nylon upper mounts and set aside for reinstallation.
2. Remove and discard the plastic strip inside the track at the bottom of the nylon upper mount.
3. Slide rubber guide into track of nylon upper mount.
4. Reinstall locking cap(s) on bottom of nylon upper mount.  
**Note: To fully lock this cap into place, you should hear two clicks.** When the cap is fully locked, it will be even with the offset part of the upper mount.
5. Repeat Procedure for second mud flap.

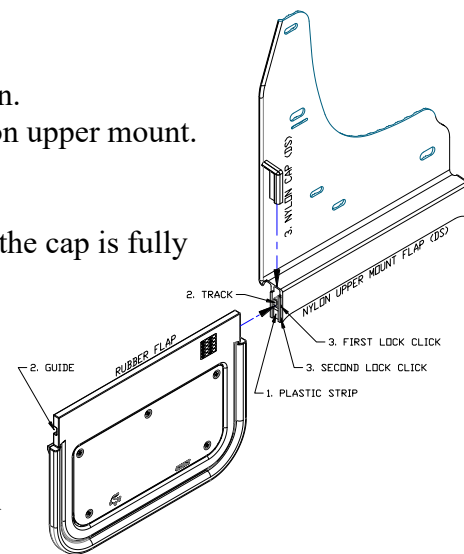

## MUD FLAPS:

**\*There is very little tire clearance in the rear wheel well. It is recommended that the tire be removed for ease of install \***

1. Before you install your Mud Flap Set, see the parts list for all necessary parts. Start on the driver's side.
3. Remove 4 factory screws from the inner wheel well.
3. Loosely install mount clips (h) on mud flap holes #2 & #3 using a capscrew (a), flat washer (d), and spacer washer (g)
4. Install mud flap hole #4 to through spacer (f) and flat washer (e) to factory hole # using a sheet metal screw (c) and flat washer (e)
5. Slid mount clips (j) behind the fender lip and loosely secure.
6. Install mud flap holes #5 & #6 to factory holes # & # using a sheet metal screw (b) and flat washer (e).
7. Install mud flap hole #1 to factory hole # using a sheet metal screw (b) and flat washer (e)
8. Using a bubble level or other levelling tool, ensure that the mud flap is level. Tighten fasteners.
9. Repeat procedure for passenger side.

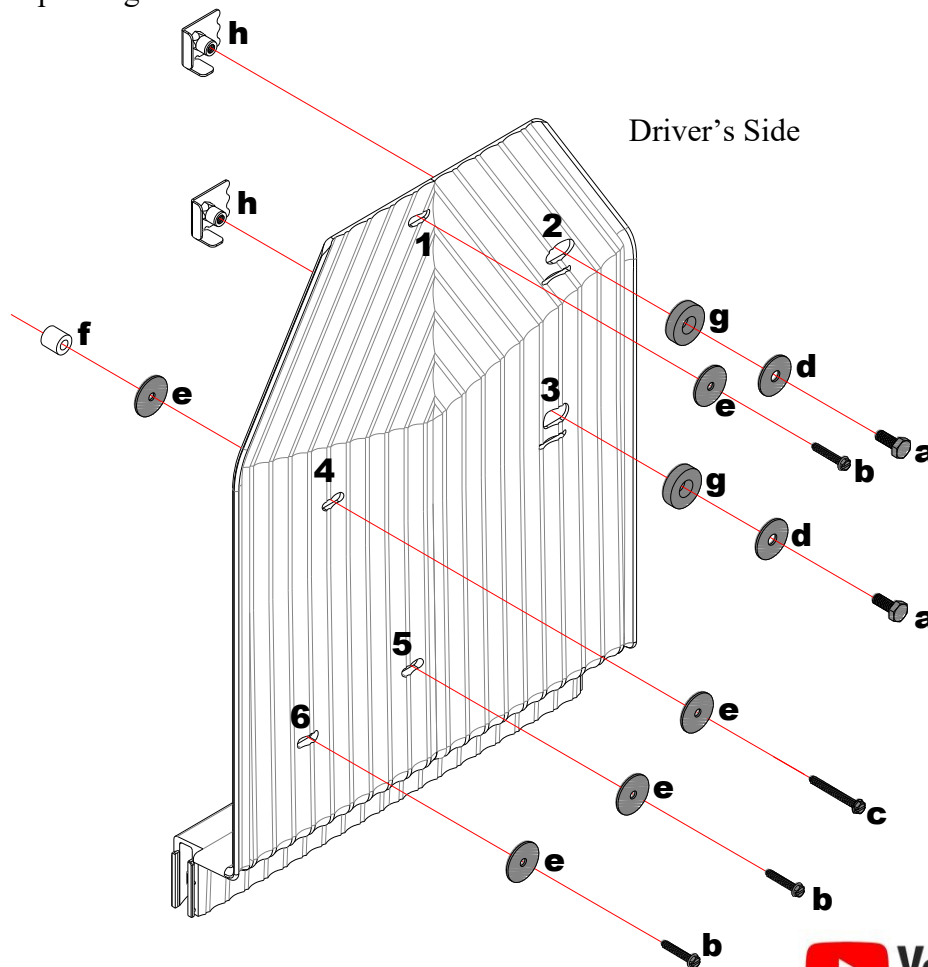

Please check out our YouTube channel to see an install video for this application.

