



GATORBACK MUDFLAPS

23-C Ford F-350/F-450, Mud Flap Set, Dual Rear Wheel Mounting Diagram & Instructions

IMPORTANT:

The manufacturer is not responsible for negligent use of vehicle with mud flaps installed, including over-tightening of screws and bolts causing damage to vehicle or mud flaps.

Before you install your Mud Flap Set, see the diagram and parts list for all necessary parts.

All hardware should be loosely installed until all mounting points have been installed and flap has been levelled. It is suggested that final tightening of hardware be done with hand tools to avoid over-tightening.

TOOLS REQUIRED:

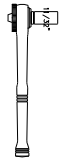

OR



10mm open or
socket wrench

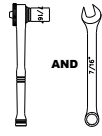

AND

7/16" open and
socket wrench

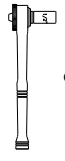

OR

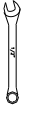

5/16" open or
socket wrench



Push Pin
Removal Tool

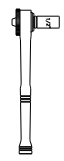

OR



1/4" open or
socket wrench



FLAPS AND BRACKETS

(1) Mud Flap
Driver Side

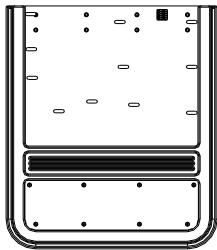

(1) Mud Flap
Passenger Side

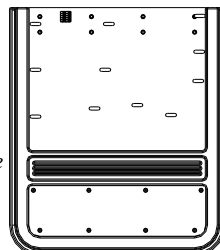

(1) Upper Bracket
Driver Side
Part #770750

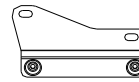

(1) Upper Bracket
Passenger Side
Part #770751

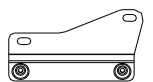

(1) Lower Bracket
Driver Side
Part #770748



(1) Lower Bracket
Passenger Side
Part #770749

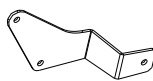

(1) Backing Plate
Driver Side
Part #770752

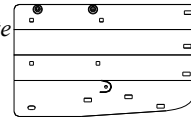

(1) Backing Plate
Passenger Side
Part #770753

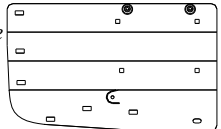

PARTS BAG #770762

a) (8) Sheet Metal Screw
#12 x 1" SS Blk Ox.
Part #010052



b) (12) Sheet Metal Screw
#12 x 1.5" SS Blk Ox.
Part #010054



c) (8) Capscrew, SS,
1/4" - 20UNC x 1"
Part #014007



d) (4) Capscrew, Button Hd.
1/4" - 20 x 5/8" SS
Part #014059



e) (2) Capscrew, SS Blk Ox
1/4" - 20UNC x 1.5"
Part #014074



f) (20) Washer, Flat
0.281" x 1" SS
Part #018068



g) (2) Washer, Flat
0.281" x 1" SS Blk Ox.
Part #018069



h) (20) Washer, Flat
0.281" x 1.5" SS Blk Ox
Part #018087

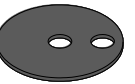

i) (14) Washer, Lock
1/4" Helicoil, SS
Part #024000



j) (14) Hex Nut
1/4" - 20, SS
Part #025000



k) (20) Expansion Nut
Nylon, #12
Part #054059



l) (20) Washer, Nylon
0.318" x 1"
Part #054061



m) (2) Washer, Nylon
0.281" x 1" Blk
Part #054084



n) (2) J-Clamp
1.5" x 2.5"
Part #767417

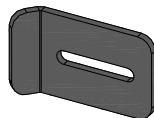

o) (4) Washer, Nylon
0.265" x 0.625" Blk
Part #054071



p) (4) Washer, Nylon
0.257" x 0.5"
Part #054097



Installation

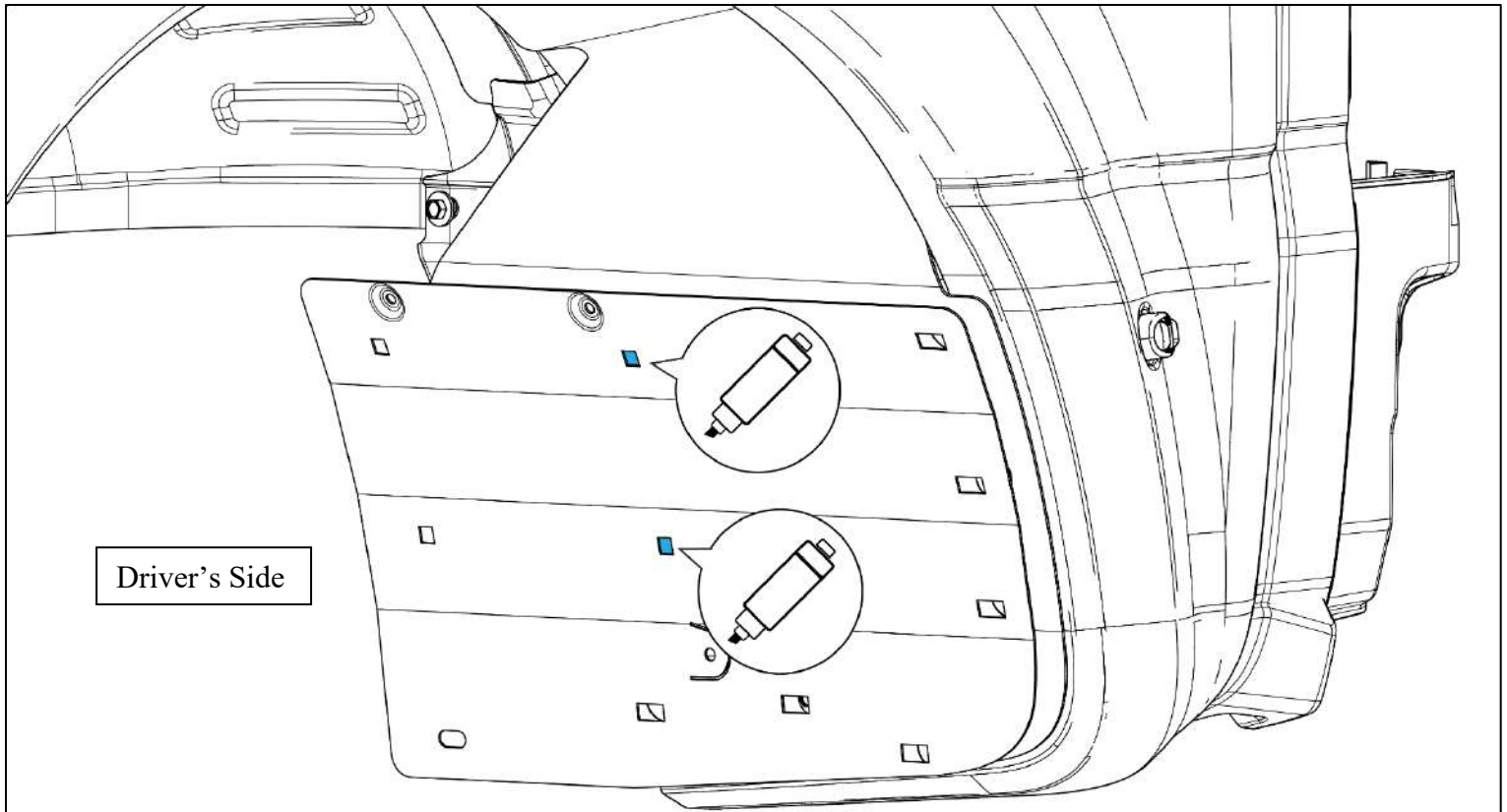

- 1-1 Hold backing plate in place, ensuring outer holes align with factory holes in the fender, then mark the liner through the two holes as shown. Set backing plate aside.

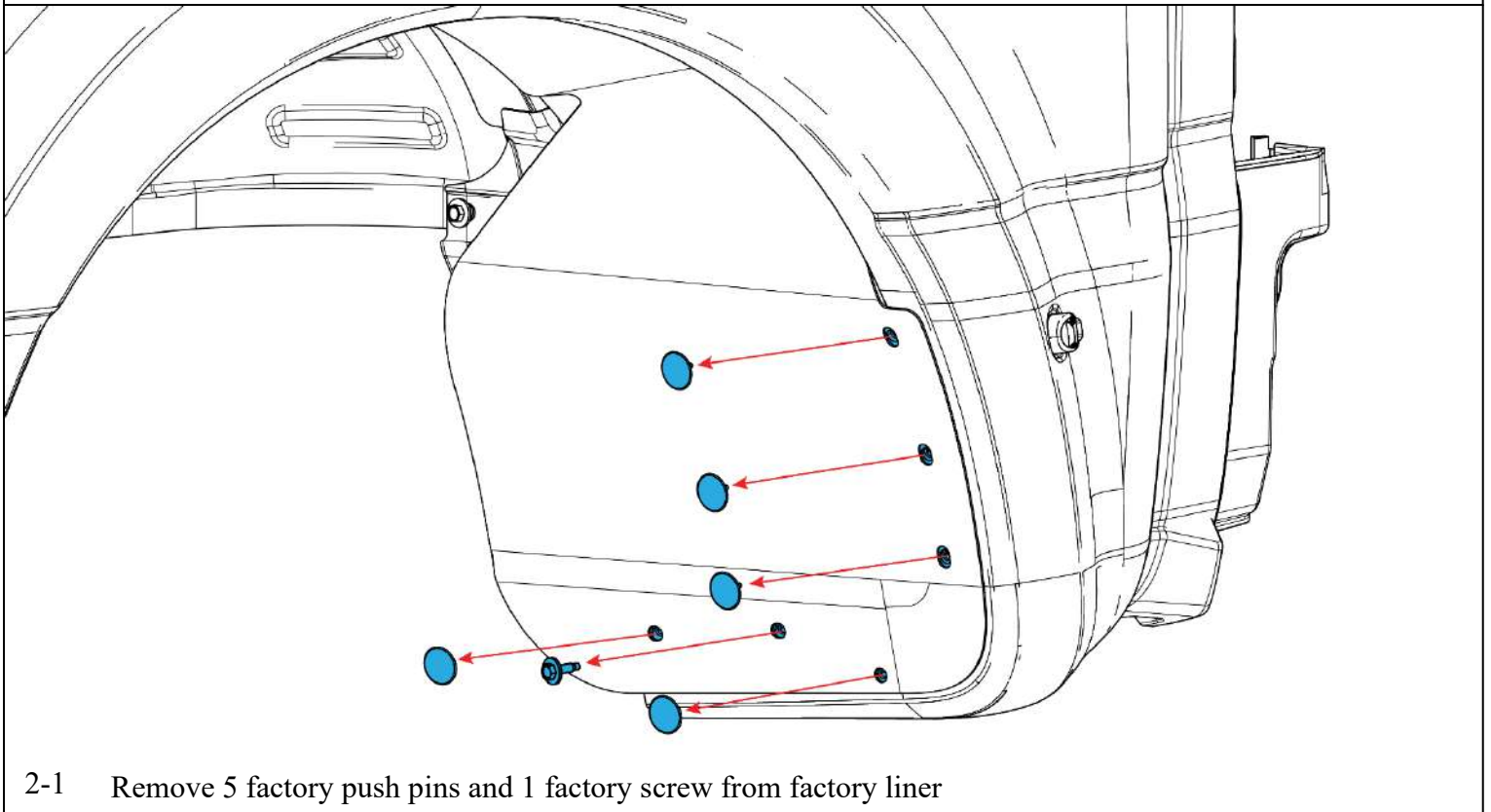

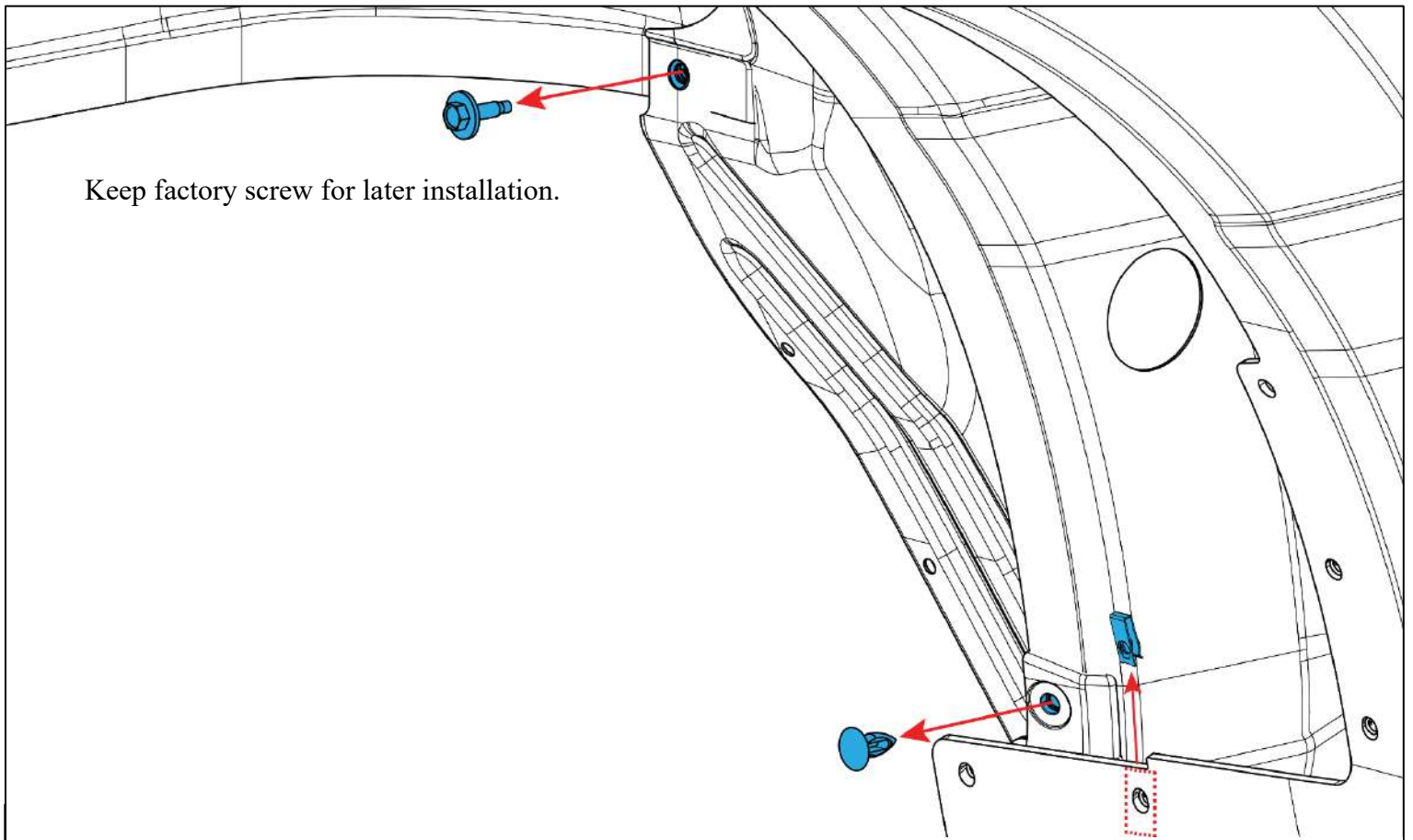

Keep factory screw for later installation.

2-2 Remove factory push pin and factory screw from wheel well, also remove factory spring nut from fender lip

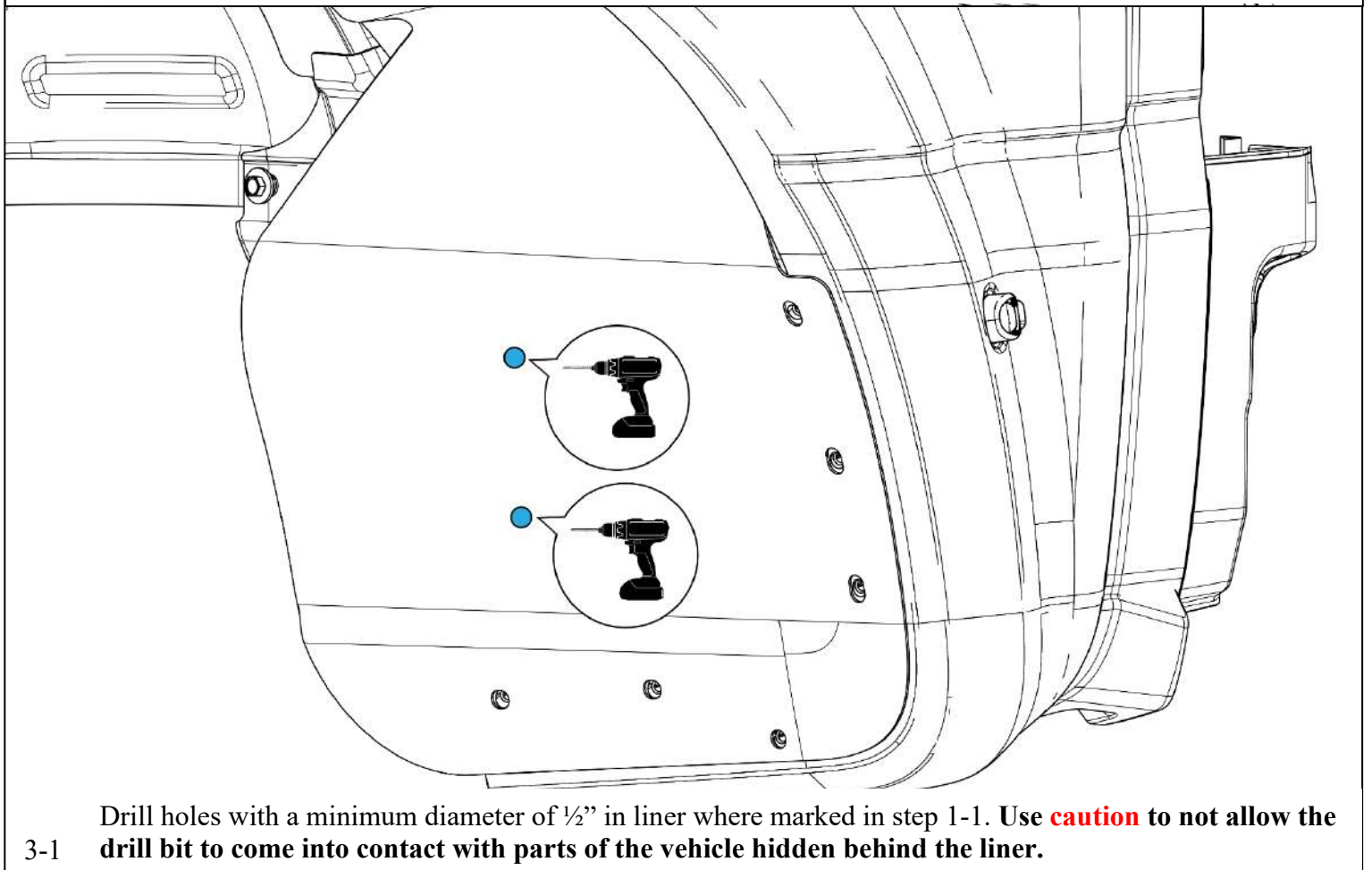

3-1 Drill holes with a minimum diameter of $\frac{1}{2}$ " in liner where marked in step 1-1. Use **caution** to not allow the drill bit to come into contact with parts of the vehicle hidden behind the liner.

Back of backing plate

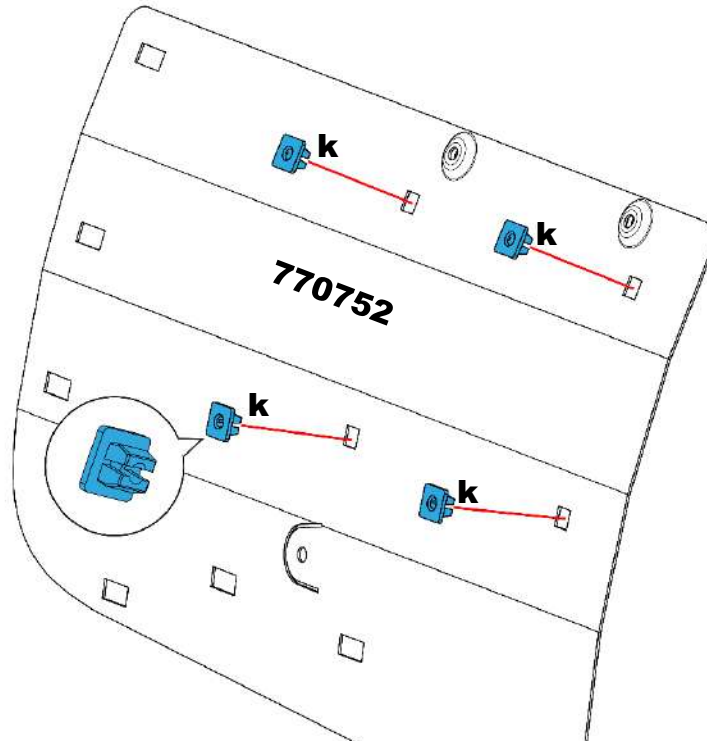

4-1 Install 4 expansion nuts (k) on the back of backing plate as shown. Note: Expansion nuts **must** be installed with slit facing horizontally.

Front of backing plate

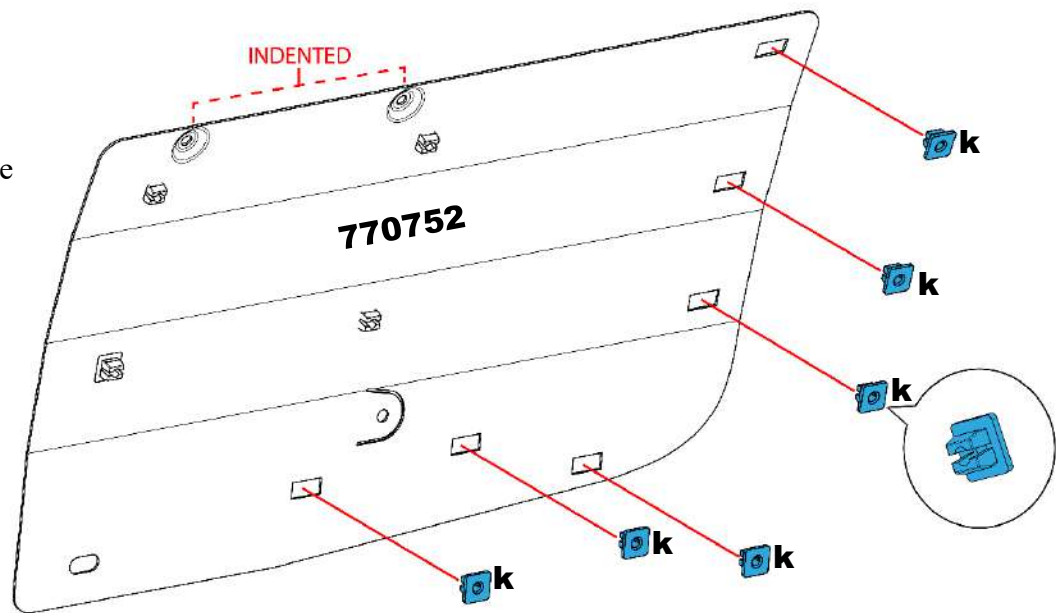

4-2 Install expansion nuts (k) on rectangular holes of backing plate as shown. Note: Expansion nuts **must** be installed with slit facing horizontally.

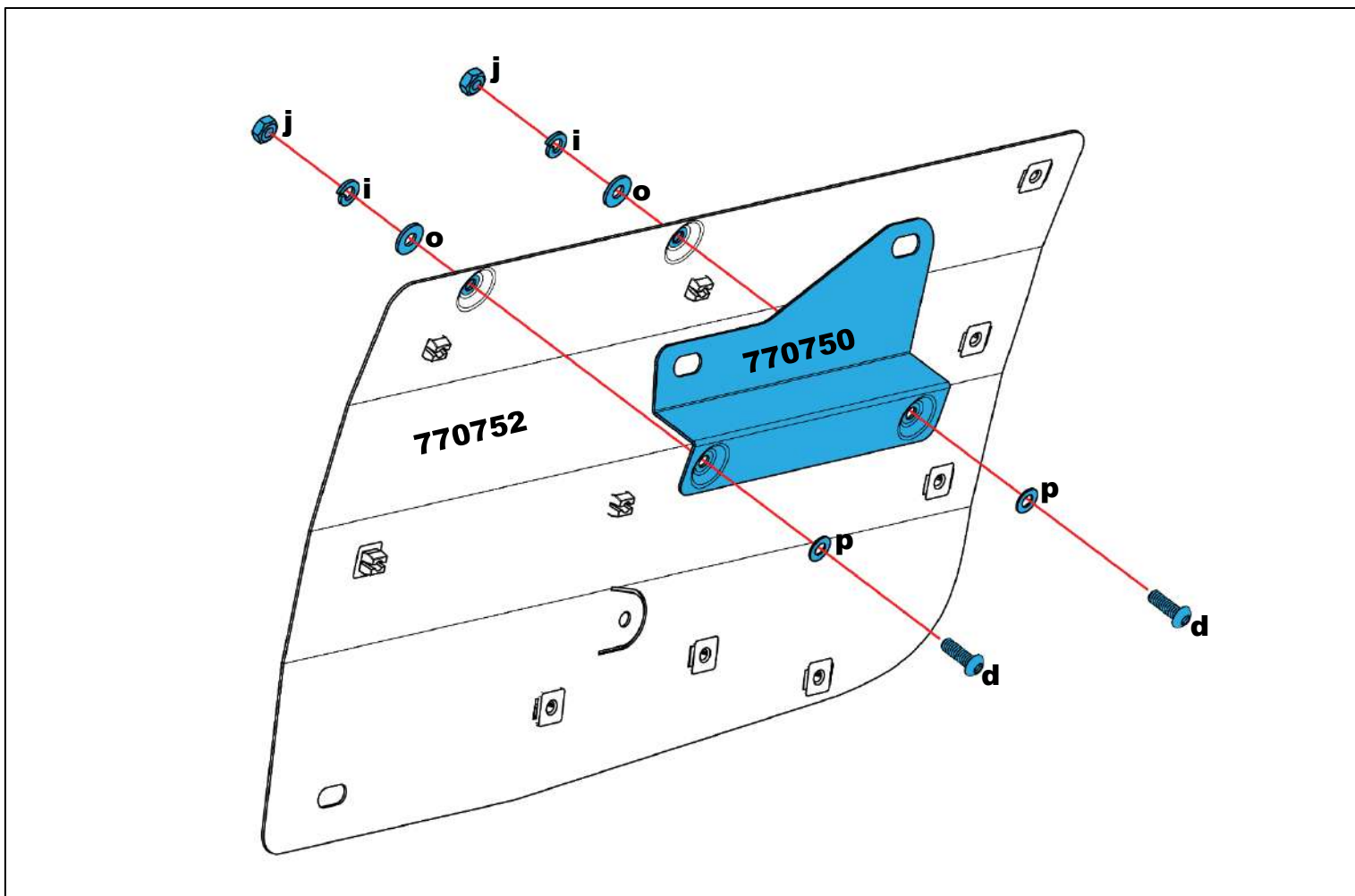

4-3 Install upper bracket to backing plate as shown

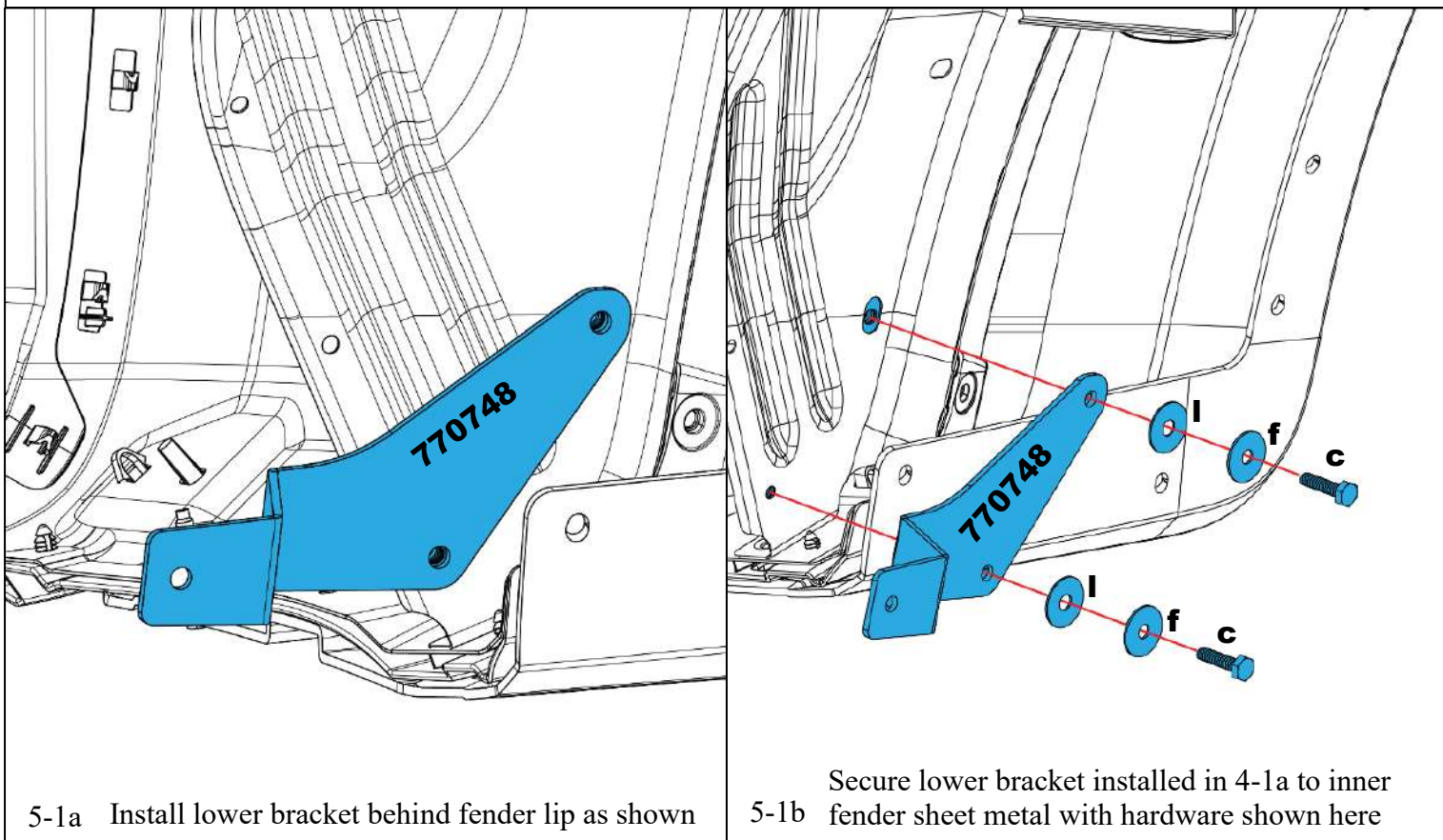

5-1a Install lower bracket behind fender lip as shown

5-1b Secure lower bracket installed in 4-1a to inner fender sheet metal with hardware shown here

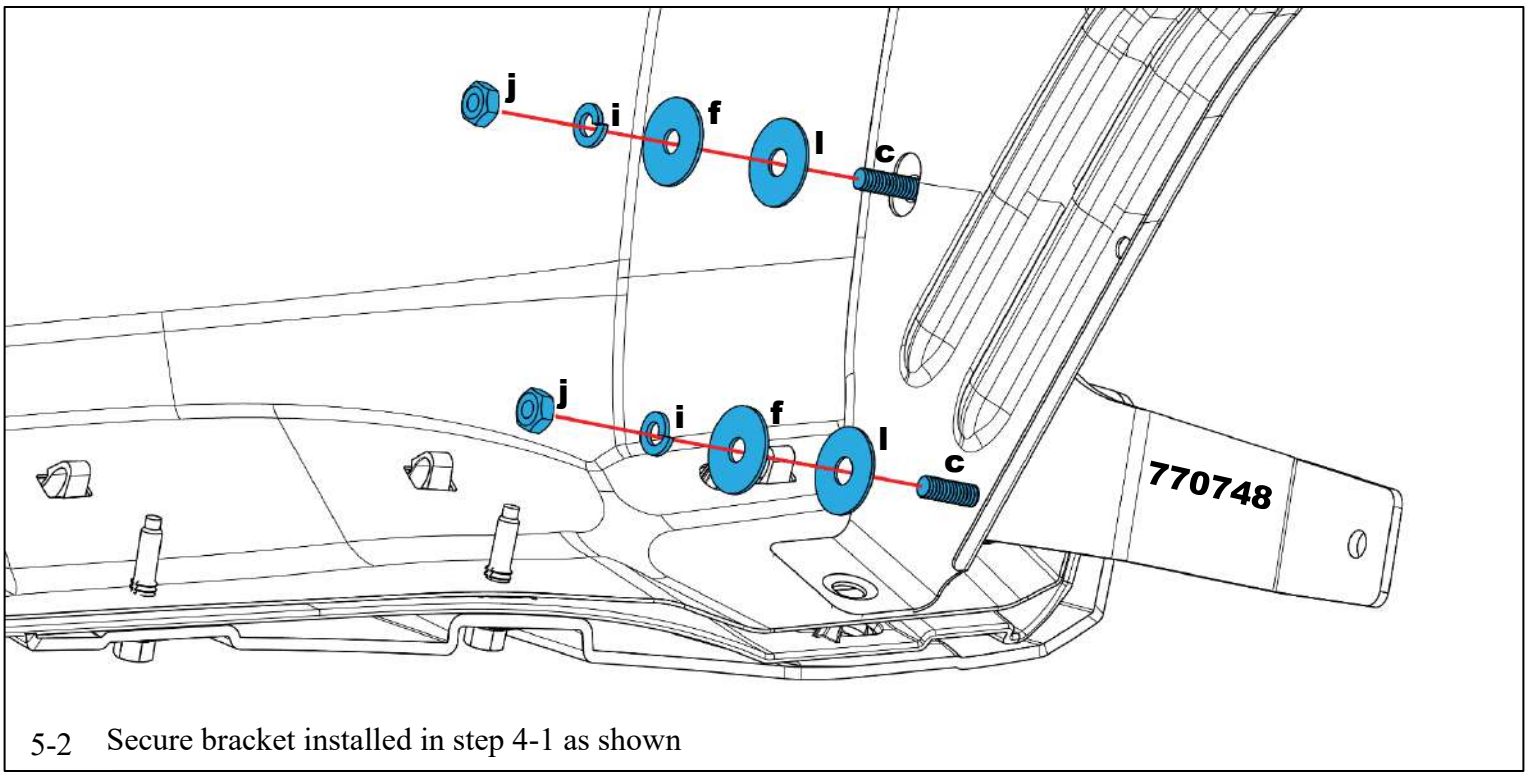

5-2 Secure bracket installed in step 4-1 as shown

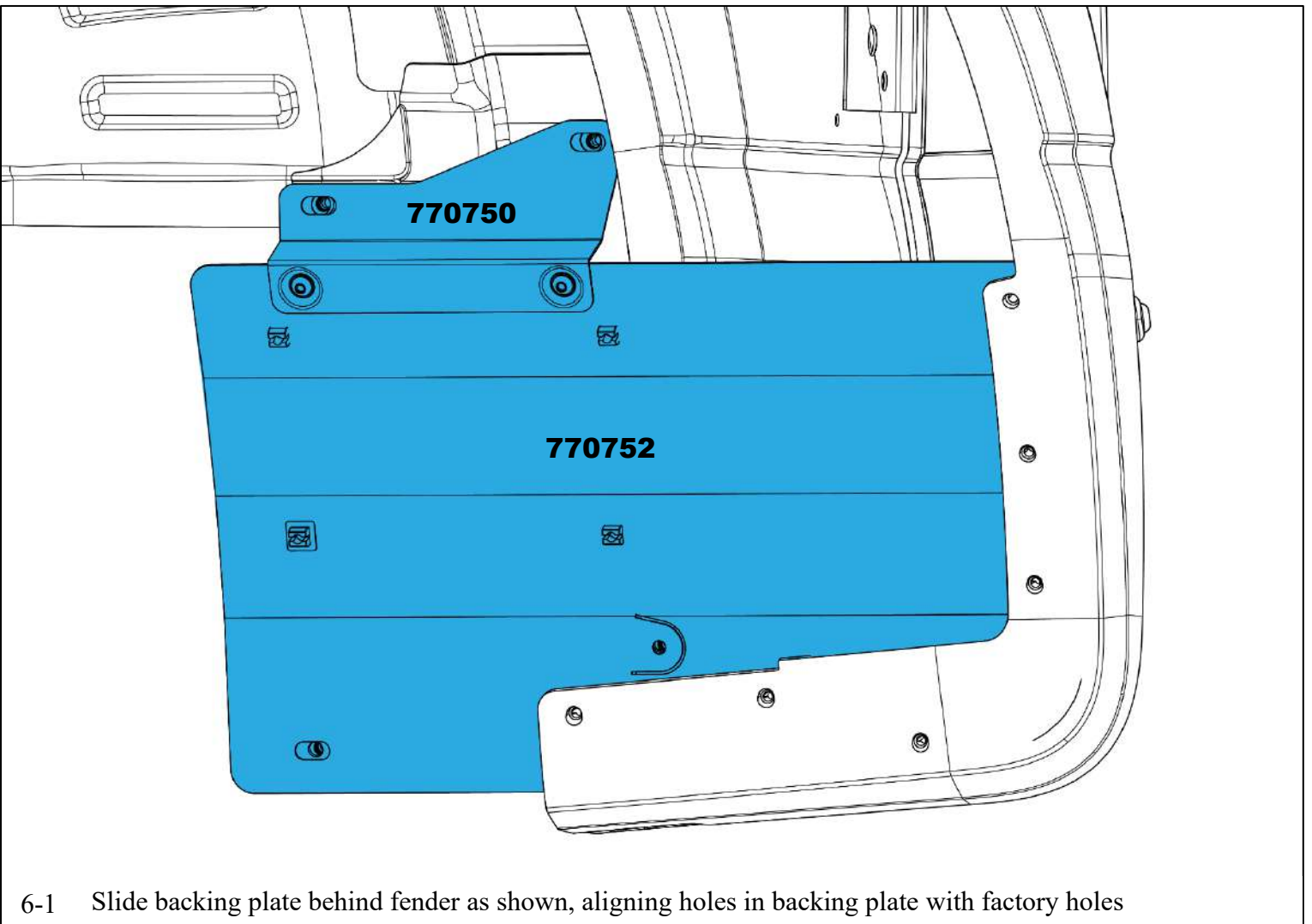

6-1 Slide backing plate behind fender as shown, aligning holes in backing plate with factory holes

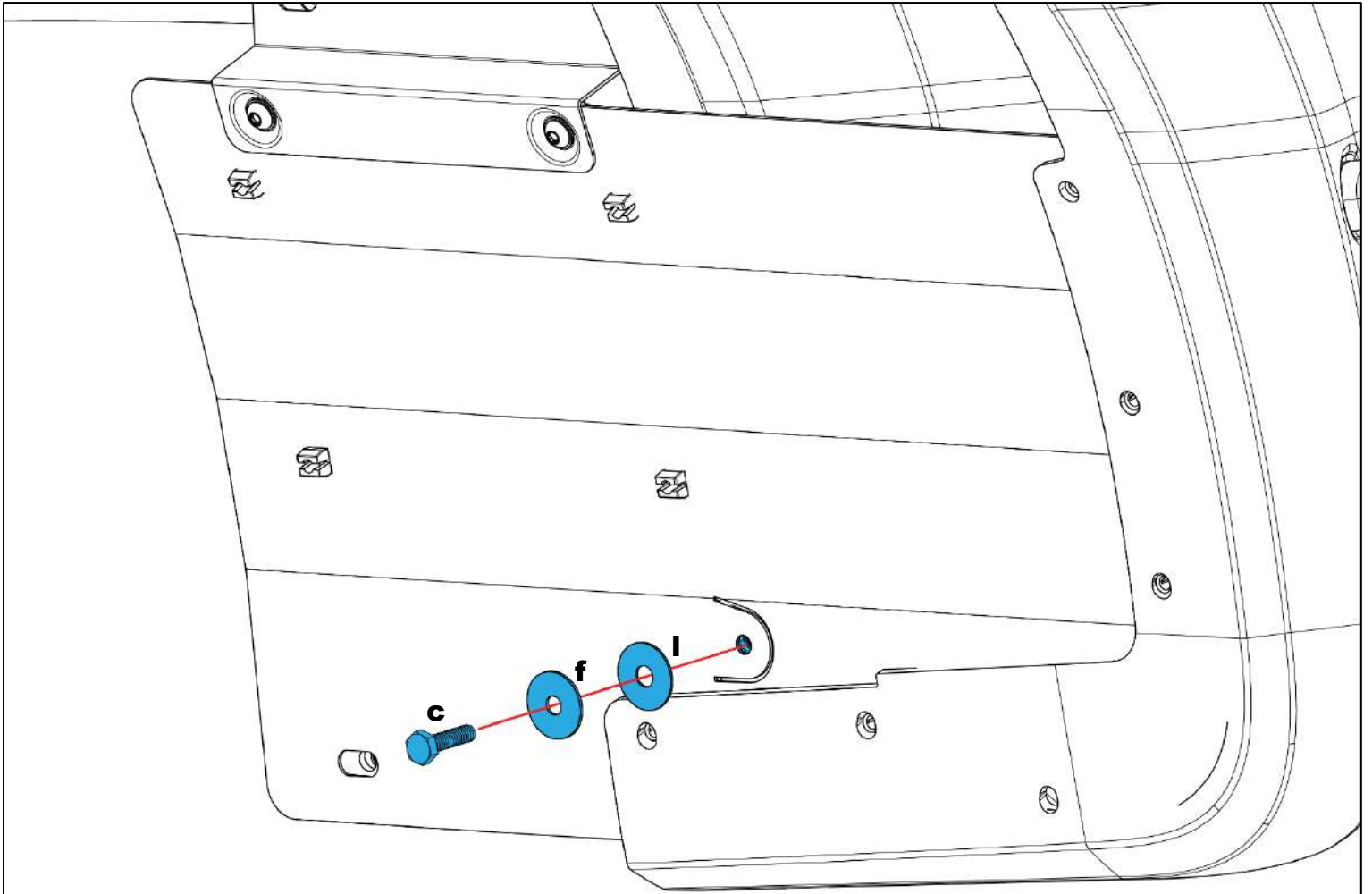

6-2 Install backing plate to factory hole as shown.

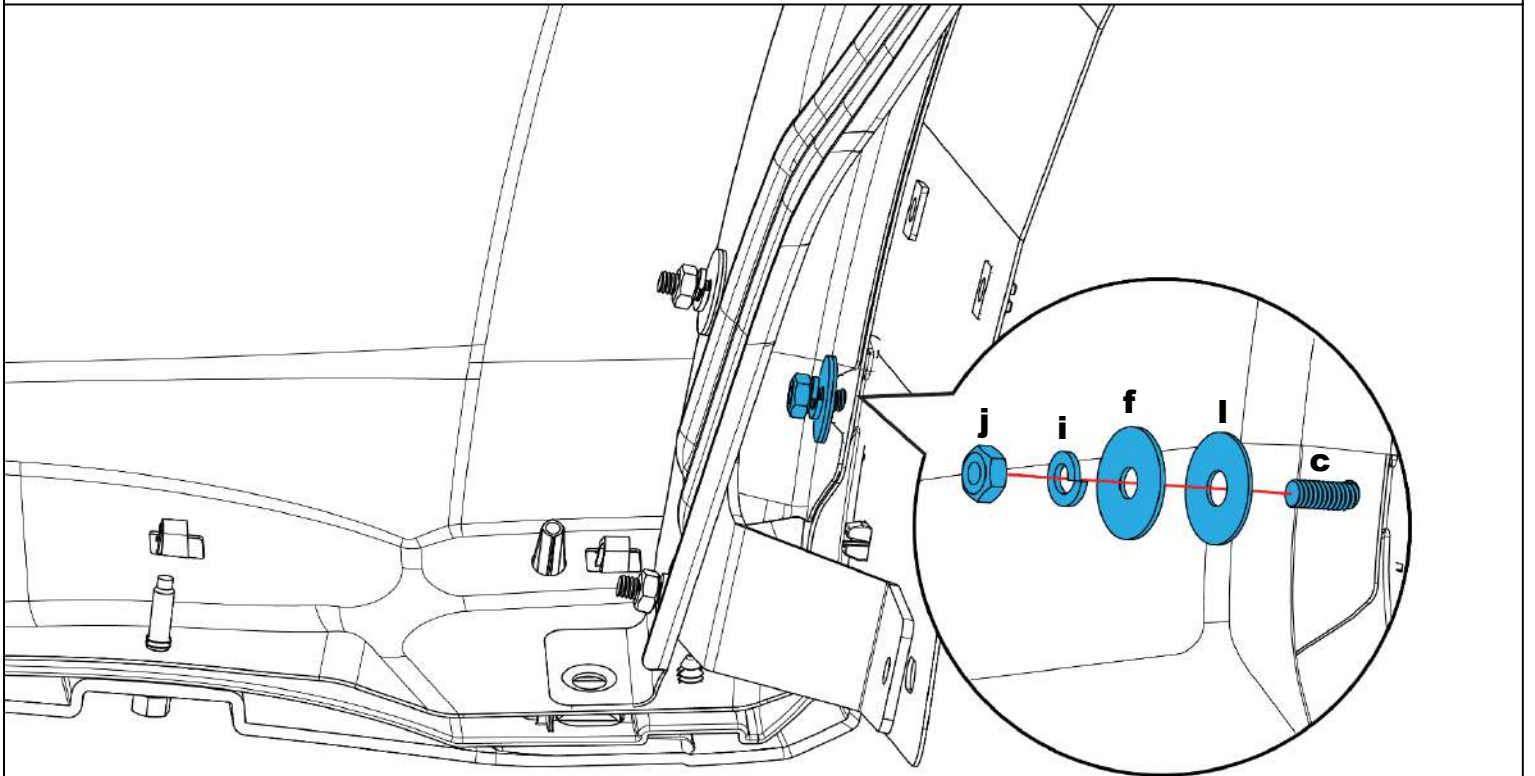

6-3 Secure hardware installed in step 5-2 as shown

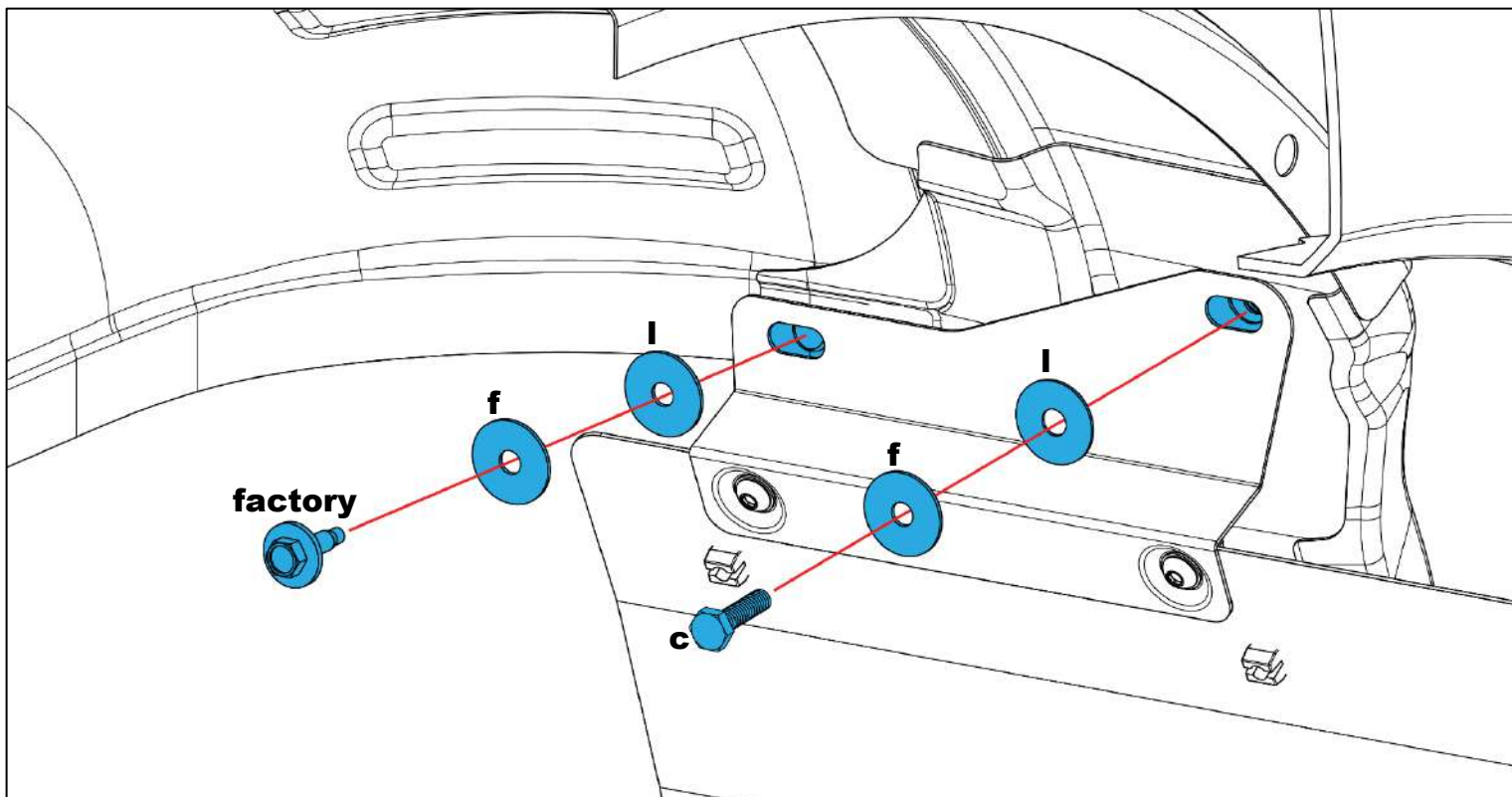

7-1 Install upper bracket to factory holes as shown

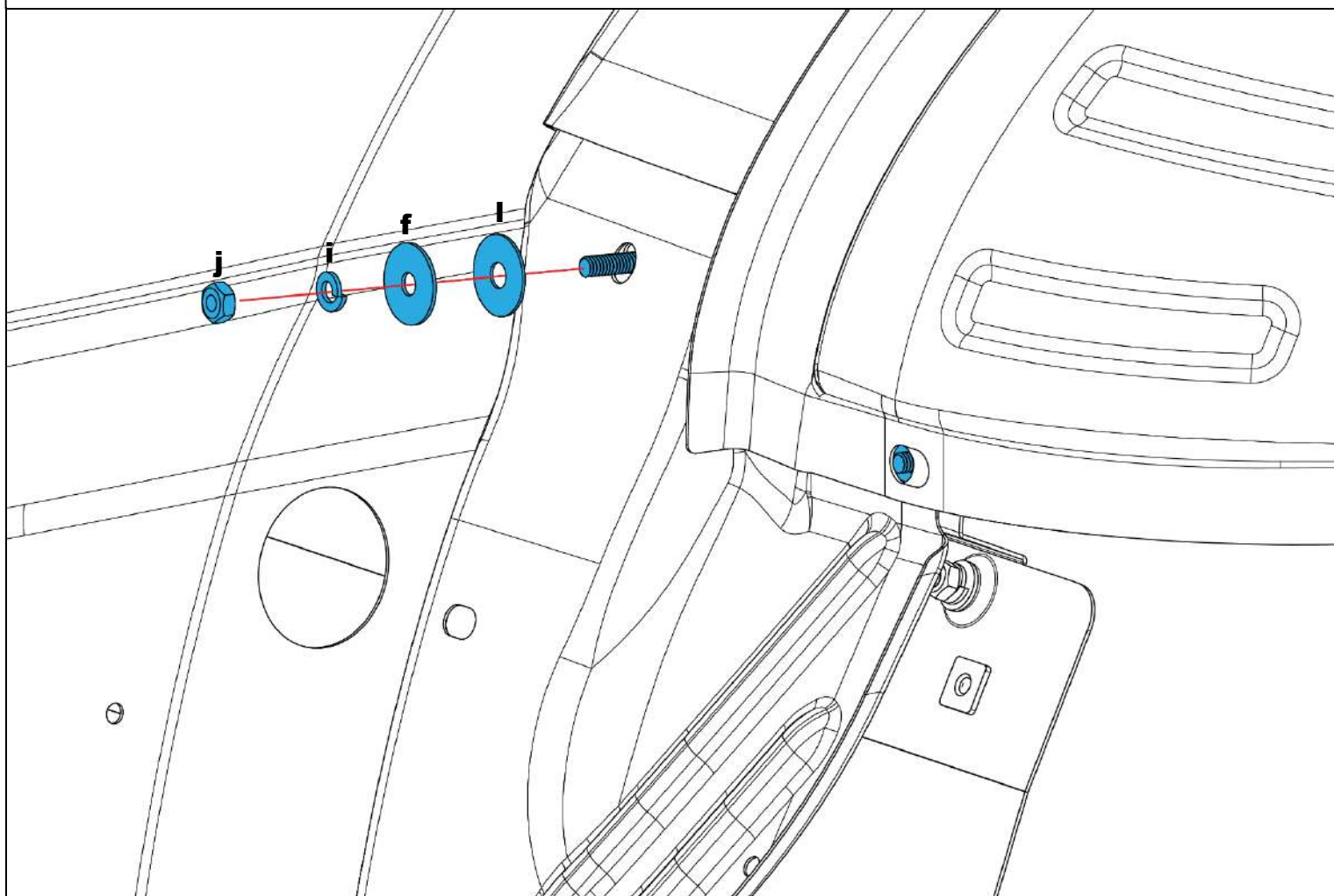

7-2 Secure bracket installed in 6-1 as shown. Tighten all hardware installed up to this point

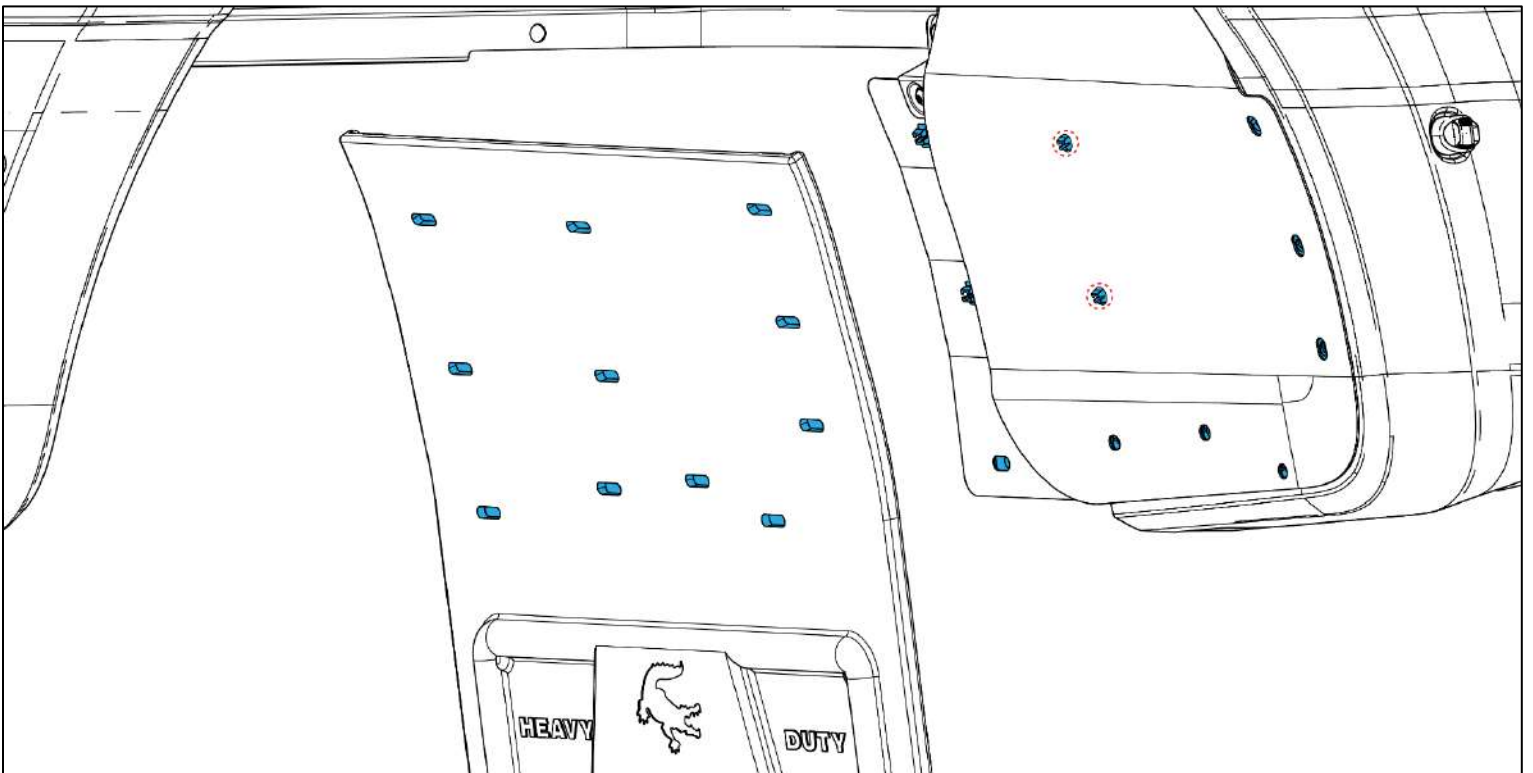

8-1 Lay factory liner back in place, ensuring expansion nuts installed on backing plate are protruding through the liner. Ensure expansion nuts on outer edge of backing plate align with factory holes. This can be adjusted using the tip of a screwdriver or pen. Align mud flap with mounting points

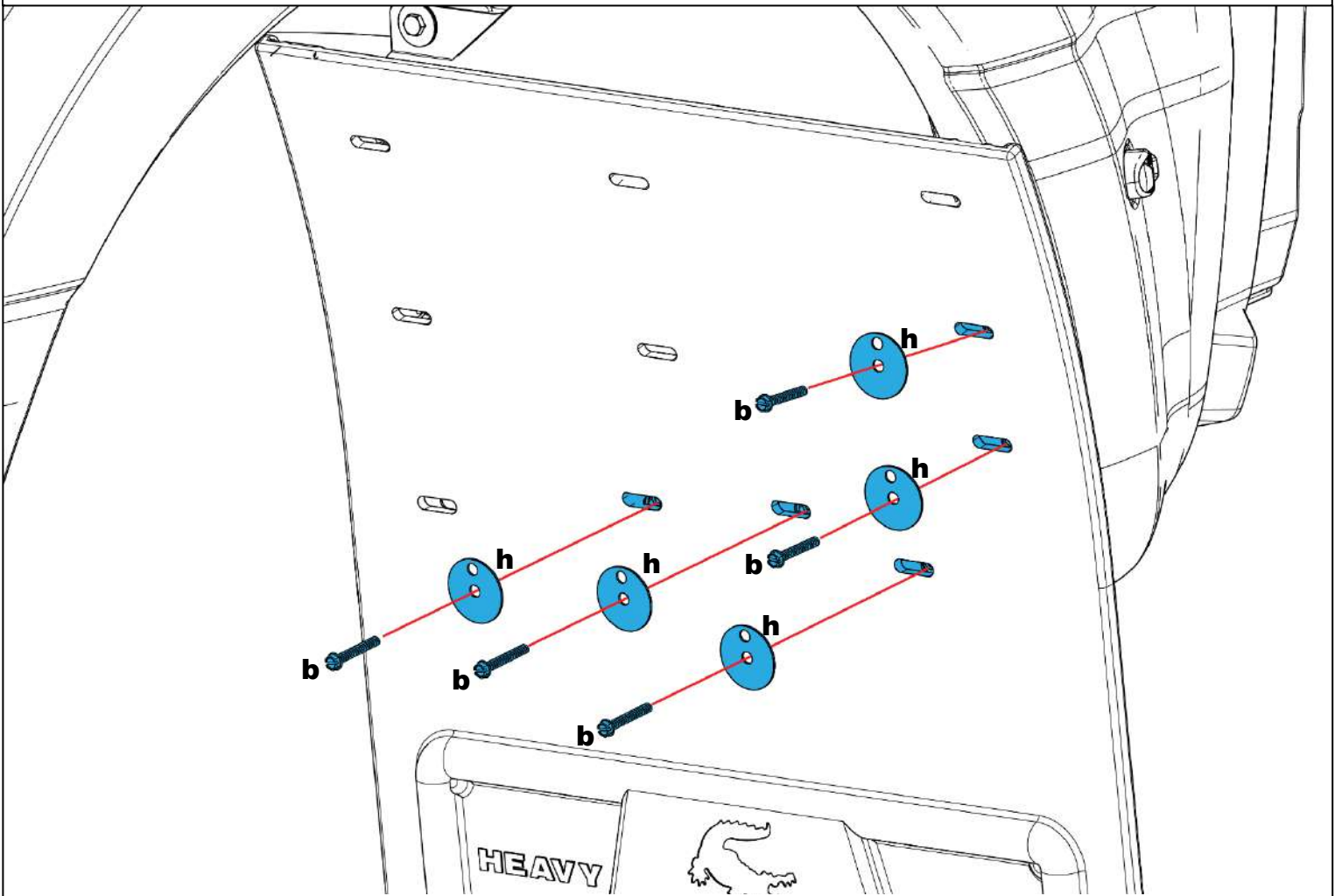

9-1 Install mud flap as shown

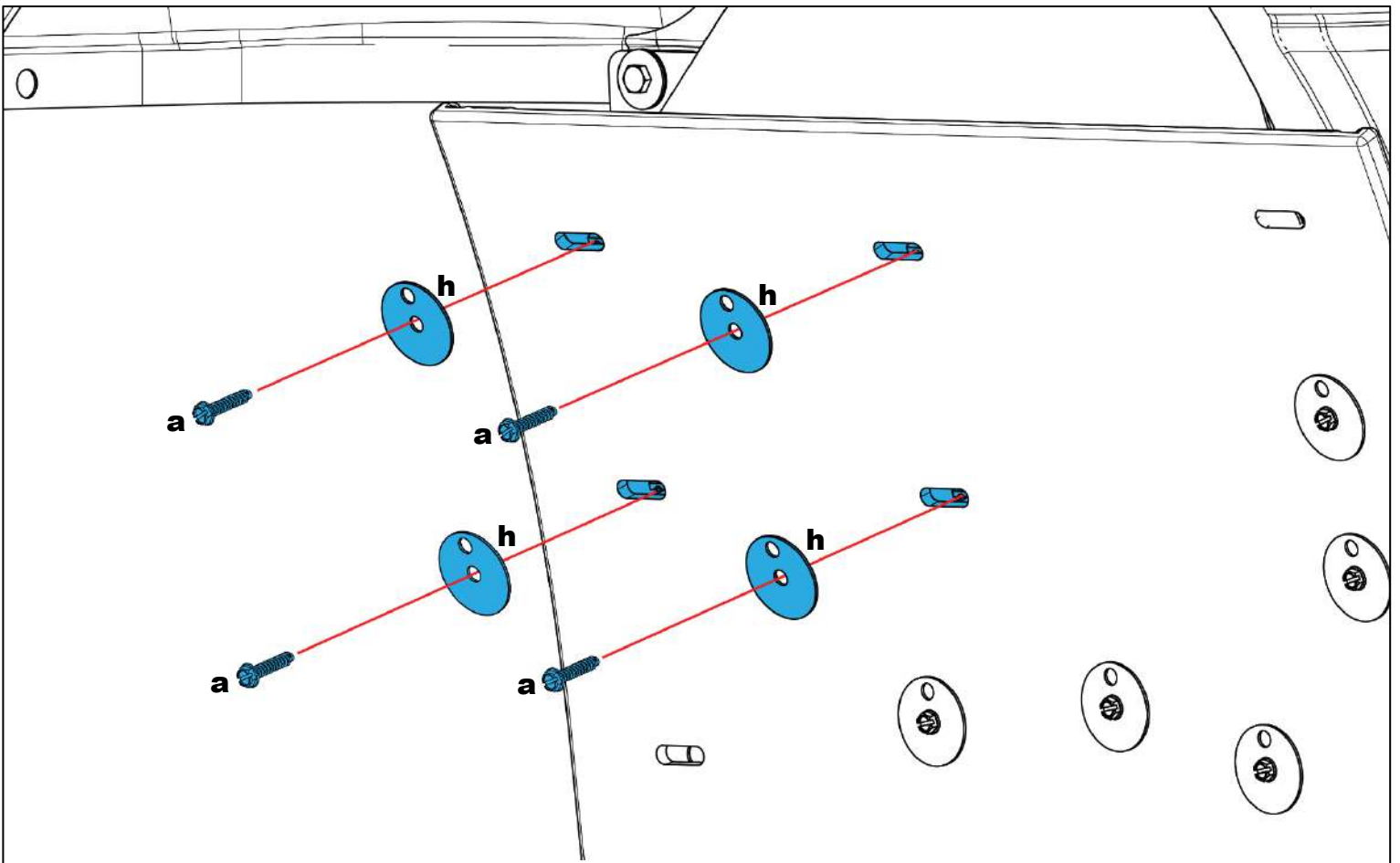

9-2 Install mud flap as shown

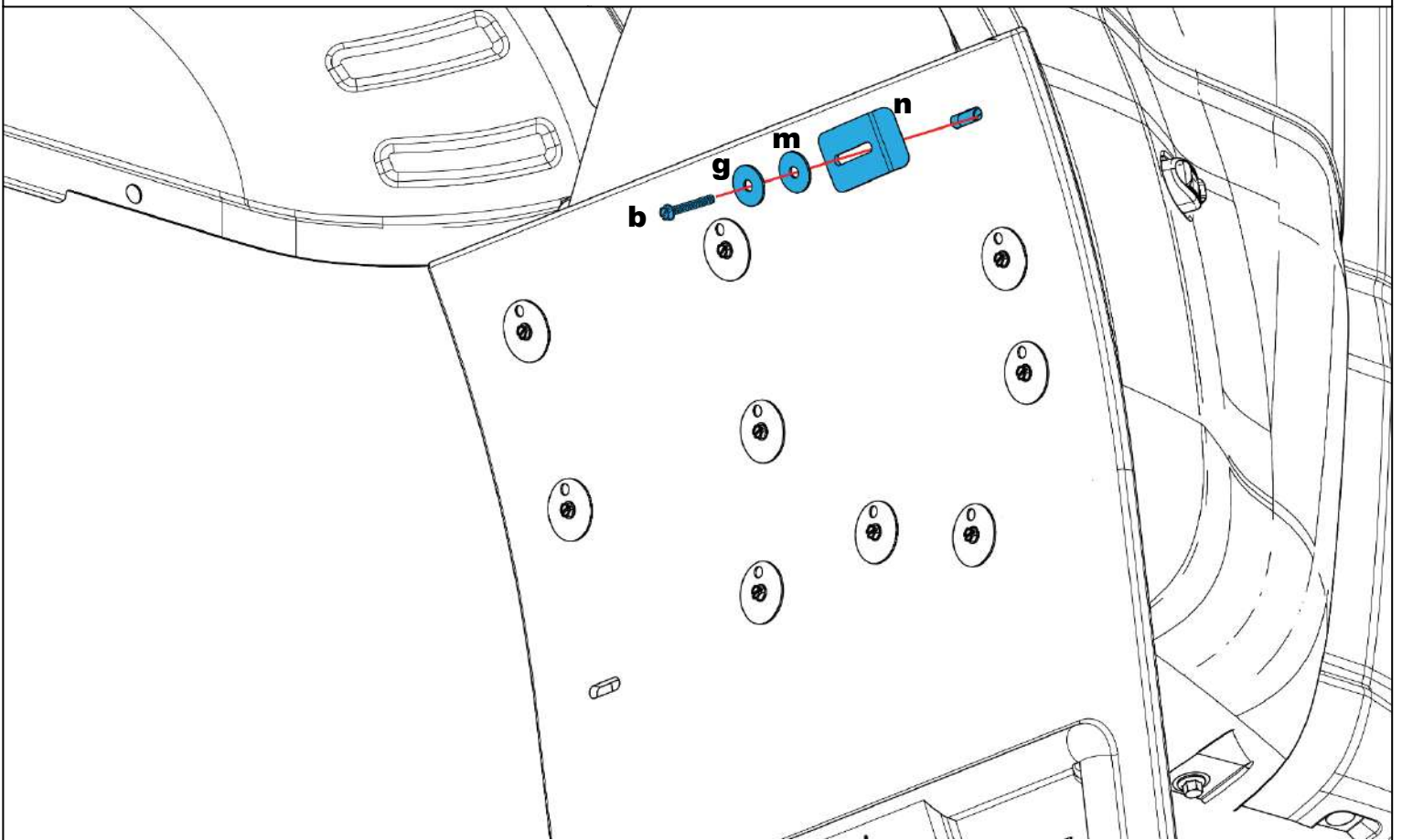

9-3 Install mud flap as shown

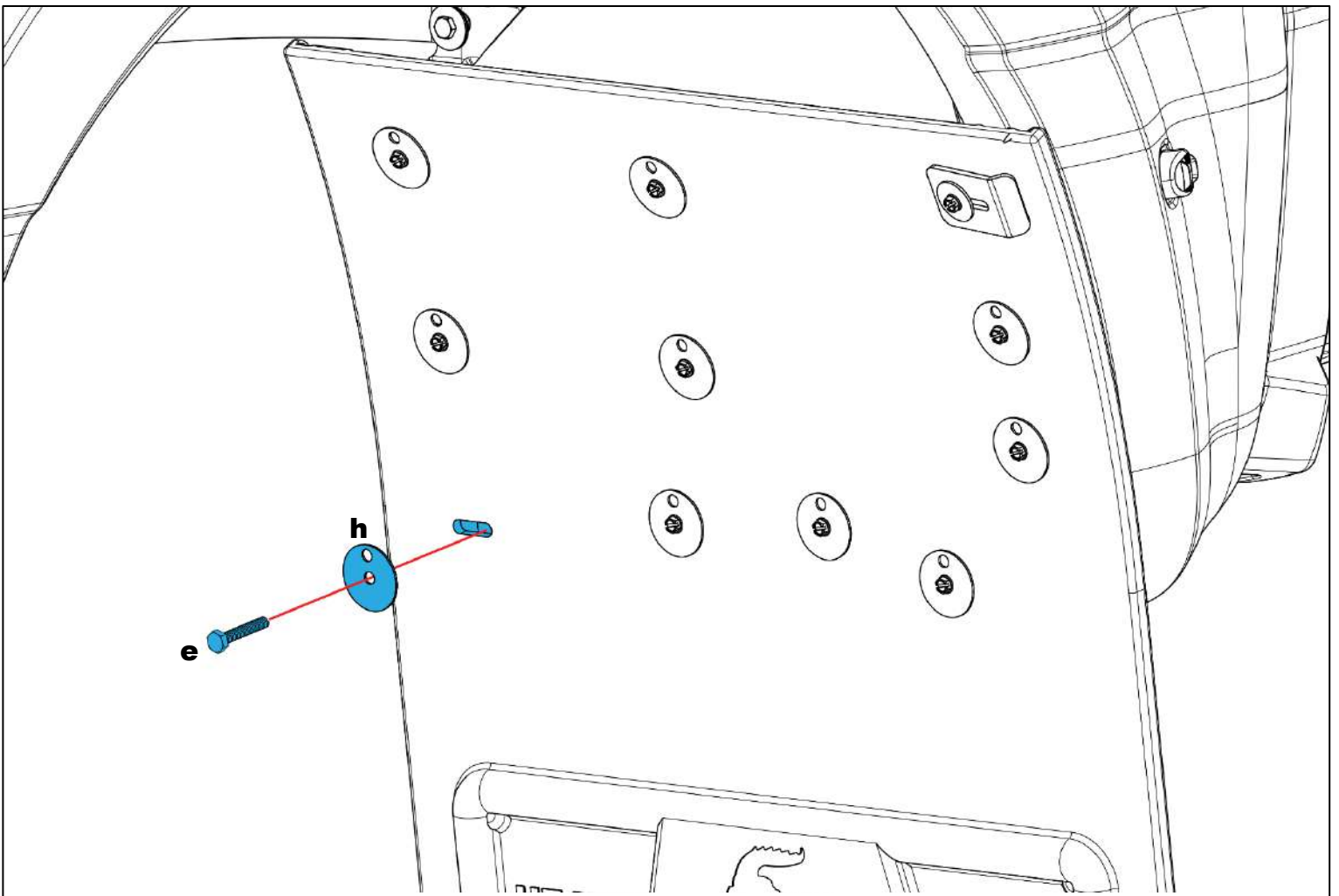

9-4 Install mud flap as shown through bracket installed in 4-1

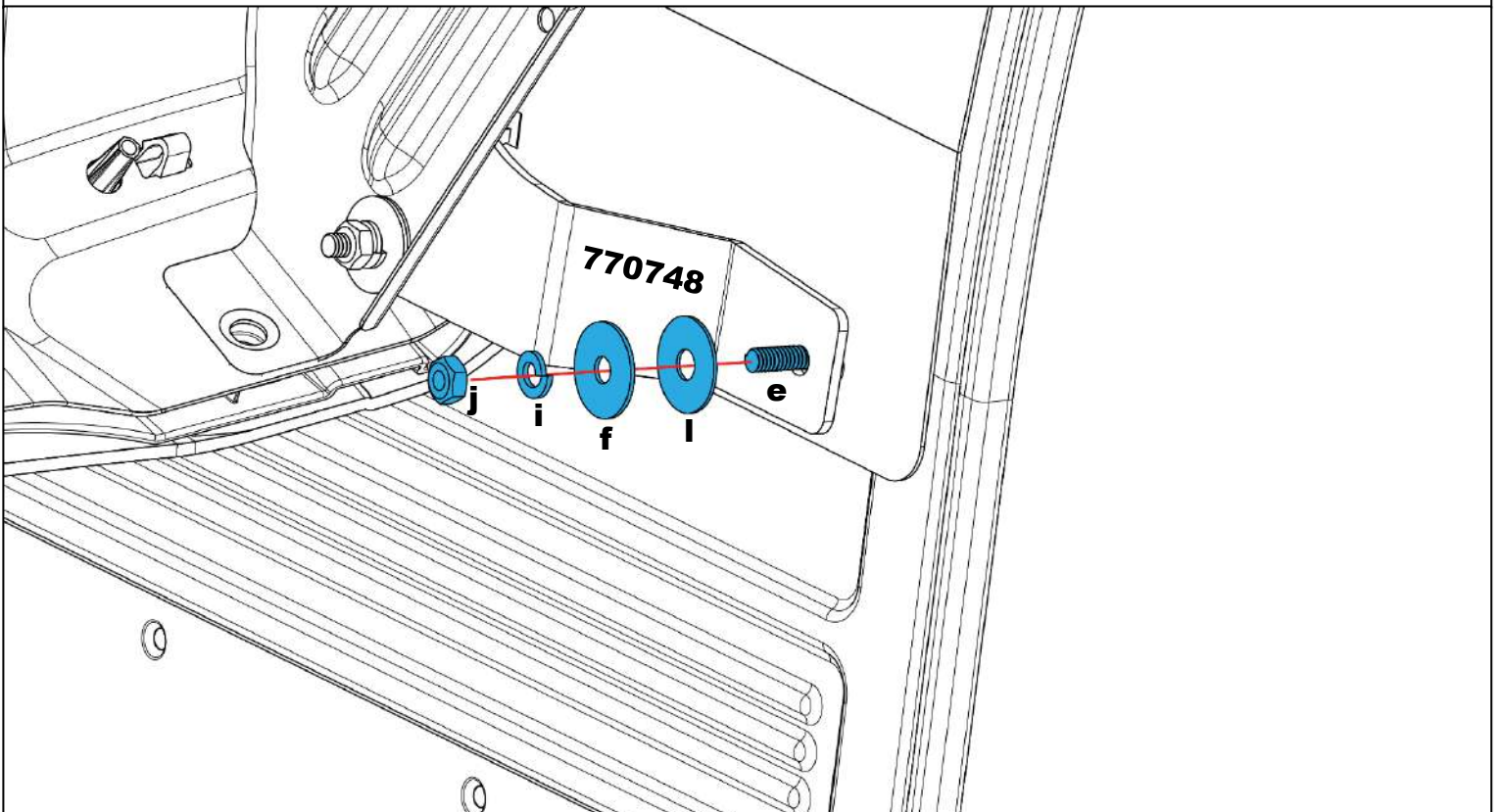

9-5 Secure hardware installed in step 8-4 as shown

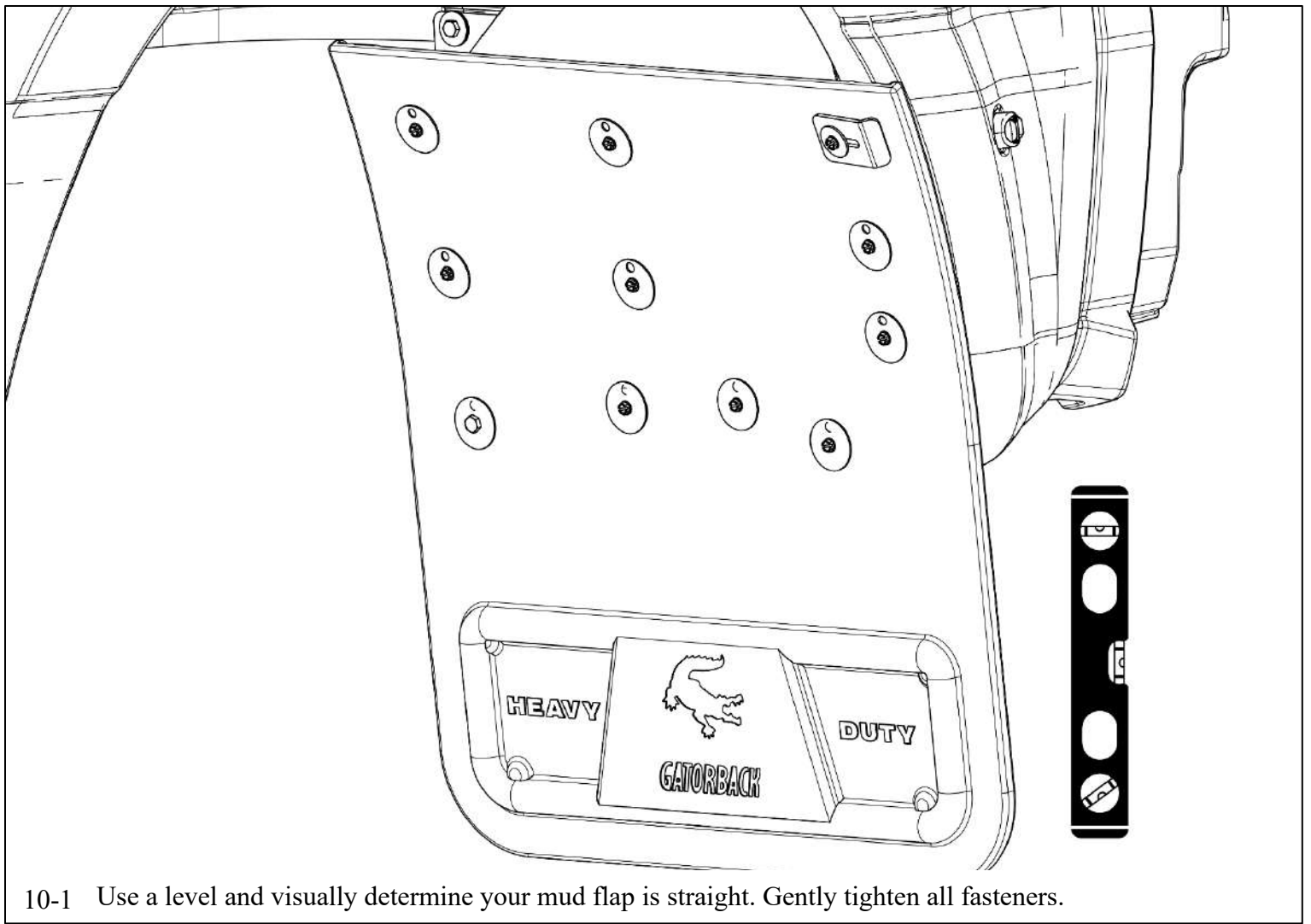

10-1 Use a level and visually determine your mud flap is straight. Gently tighten all fasteners.