



**2019-2022 Chev Silverado**  
**Mud Flap Set, Front**  
**Mounting Diagram & Instructions**  
**Kit# RCR28F**

**IMPORTANT:**

*Manufacturer is not responsible for negligent use of vehicle with mud flaps installed, including over-tightening of screws and bolts causing damage to vehicle or mud flaps.*



**TOOLS REQUIRED-**

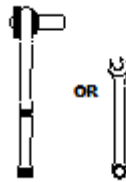

5/16" Open Wrench or  
Socket Wrench

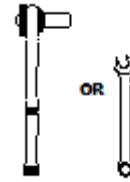

7/16" Open Wrench or  
Socket Wrench

**FLAPS**

(1)Flap Assy  
Rear, DS

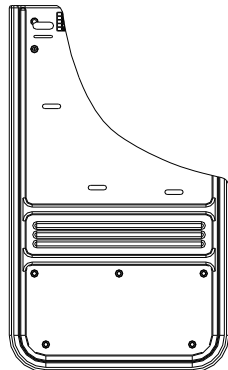

(1)Flap Assy  
Rear, PS

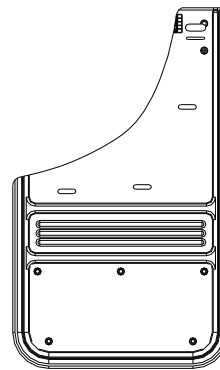

**PARTS BAG # 767263**

a) (2) Washer, Flat  
0.281" x 1", 18g, SS, oxidized  
Part #018069

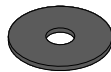

b) (6) Washer, Flat  
0.203" x 1", 18g, SS, oxidized  
Part #018070

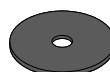

c) (2) Capscrew, SS  
1/4"-20UNC x 3/4"  
Part #014070



d) (6) Hex Bolt, SS  
M4.2 x 1", w/Logo  
Part # 016041

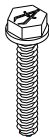

e) (1) Mount Clip, DS  
w/Clinch Nut  
Part # 767068

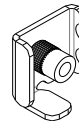

f) (1) Mount Clip, PS  
w/Clinch Nut  
Part #767069

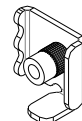

g) (2) Rubber Washer  
1/4"ID x 1"OD x 1/4"  
Part #080677

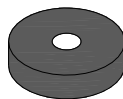

## INSTALLATION *(For ease of installation it is suggested that the wheel be removed)*

1. Before you install your Mud Flap Set, see the diagram and parts list for all necessary parts. Start on the driver's side.
2. Remove 4 factory screws from holes #1 to #4. \*Removal process may vary dependent on the factory guard style\*
3. Push liner back to expose clip on inside of factory guard. Pinch clip on inside of guard and pull back to remove.
4. Remove factory screw from hole #5.
5. Secure the mud flap through hole #1 to hole #5 using supplied bolt (016041), washer (018070), and rubber spacer (080677) and through hole #3 to hole #7, and through hole #2 to hole #6 using supplied bolt (016041) and washer (018070). Loosely secure at this point.
6. Install mount clip on holes #4 using supplied bolt (014070) and washer (018069) Slide mount clip behind the lip of the fender to secure.
7. Using a bubble level or other levelling tool, ensure that the mud flap is level. Tighten fasteners on holes #1 to #4.
8. Repeat on passenger side.
9. \*\*OPTIONAL\*\* Install optional plugs (sold separately) into holes on outside of the fender.

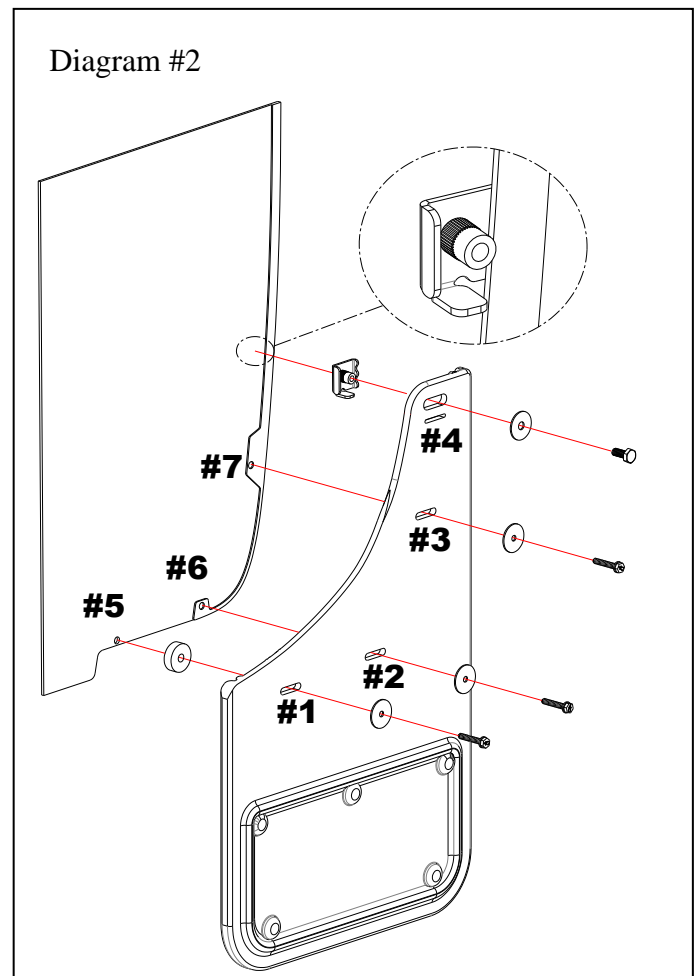
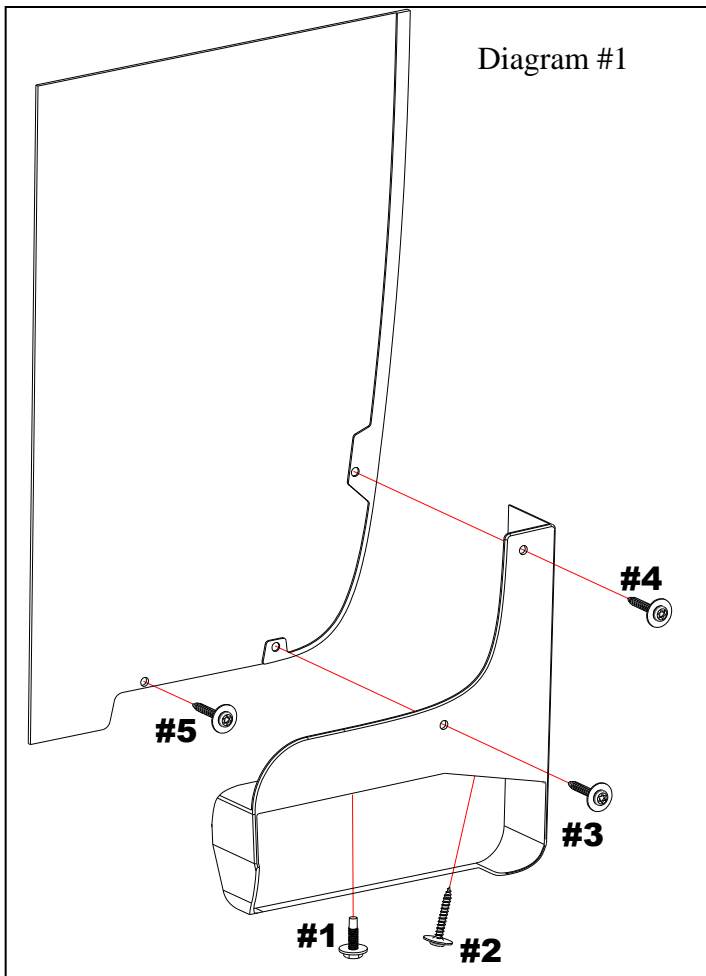

Please check out our YouTube channel to see an install video for this application.





**2019-2022 Chev Silverado**  
**Mud Flap Set, Rear**  
**Mounting Diagram & Instructions**  
**Kit# RCR28R**

**IMPORTANT:**

*Manufacturer is not responsible for negligent use of vehicle with mud flaps installed, including over-tightening of screws and bolts causing damage to vehicle or mud flaps.*



**TOOLS REQUIRED-**

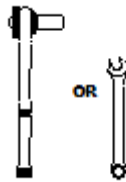

5/16" Open Wrench or  
Socket Wrench

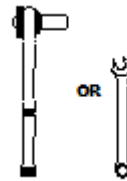

7/16" Open Wrench or  
Socket Wrench

**FLAPS**

(1) Flap Assy  
Rear, DS  
Part #

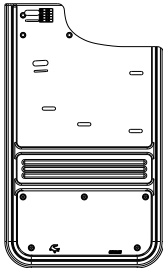

(1) Flap Assy  
Rear, PS  
Part #

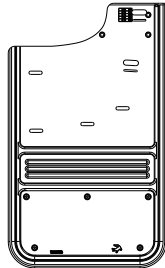

(1) Bracket  
Rear, DS  
Part #767066

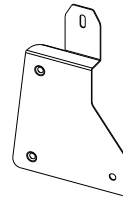

(1) Bracket  
Rear, PS  
Part #767067

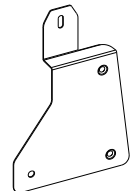

**PARTS BAG # 767076**

a) (4) Washer, Flat  
0.281" x 1", 18g, SS, oxidized  
Part #018069

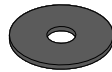

b) (8) Washer, Flat  
0.203" x 1", 18g, SS, oxidized  
Part #018070



c) (4) Capscrew, SS  
1/4"-20UNC x 3/4"  
Part #014070



d) (8) Hex Bolt, SS  
M4.2 x 1", w/Logo  
Part # 016041

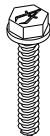

e) (2) Mount Clip, DS  
w/Clinch Nut  
Part # 767068

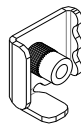

f) (2) Mount Clip, PS  
w/Clinch Nut  
Part #767069

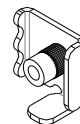

g) (2) Rad Grill Nut  
#8 Thread, Zinc Pltd  
Part #016049

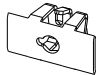

## INSTALLATION *(For ease of installation it is suggested that the wheel be removed)*

2. Before you install your Mud Flap Set, see the diagram and parts list for all necessary parts. Start on the driver's side.
2. For vehicles **without** liners, remove 2 factory screws from holes #2 & #3.  
For vehicles **with** liners, remove 3 factory screws from holes #1 to #3.
3. For vehicles **without** liners, install clip (016049) into hole #1 as shown in Diagram A-1.
4. Loosely install the bracket through hole #4 into hole #1 using a previously removed factory screw. (For trucks without liners, reuse factory screw from hole #3.)
5. Loosely install mud flap through hole #9 to bracket hole #7 through factory hole #2, then hole #11 to factory hole #3 using supplied bolt (016041) and washer (018070)
6. Secure the mud flap through holes #8 to bracket hole #6 & mud flap hole #10 to the bracket hole #5 using supplied bolt (016041) and washer (018070). Loosely secure at this point.
7. Install mount clips on holes #12 & #13 using supplied bolts (014070) and washers (018069) See Diagram A-2.
8. Using a bubble level or other levelling tool, ensure that the mud flap is level. Tighten all fasteners.
9. Slide clips behind fender lip to secure and tighten fasteners.
10. Repeat on passenger side.

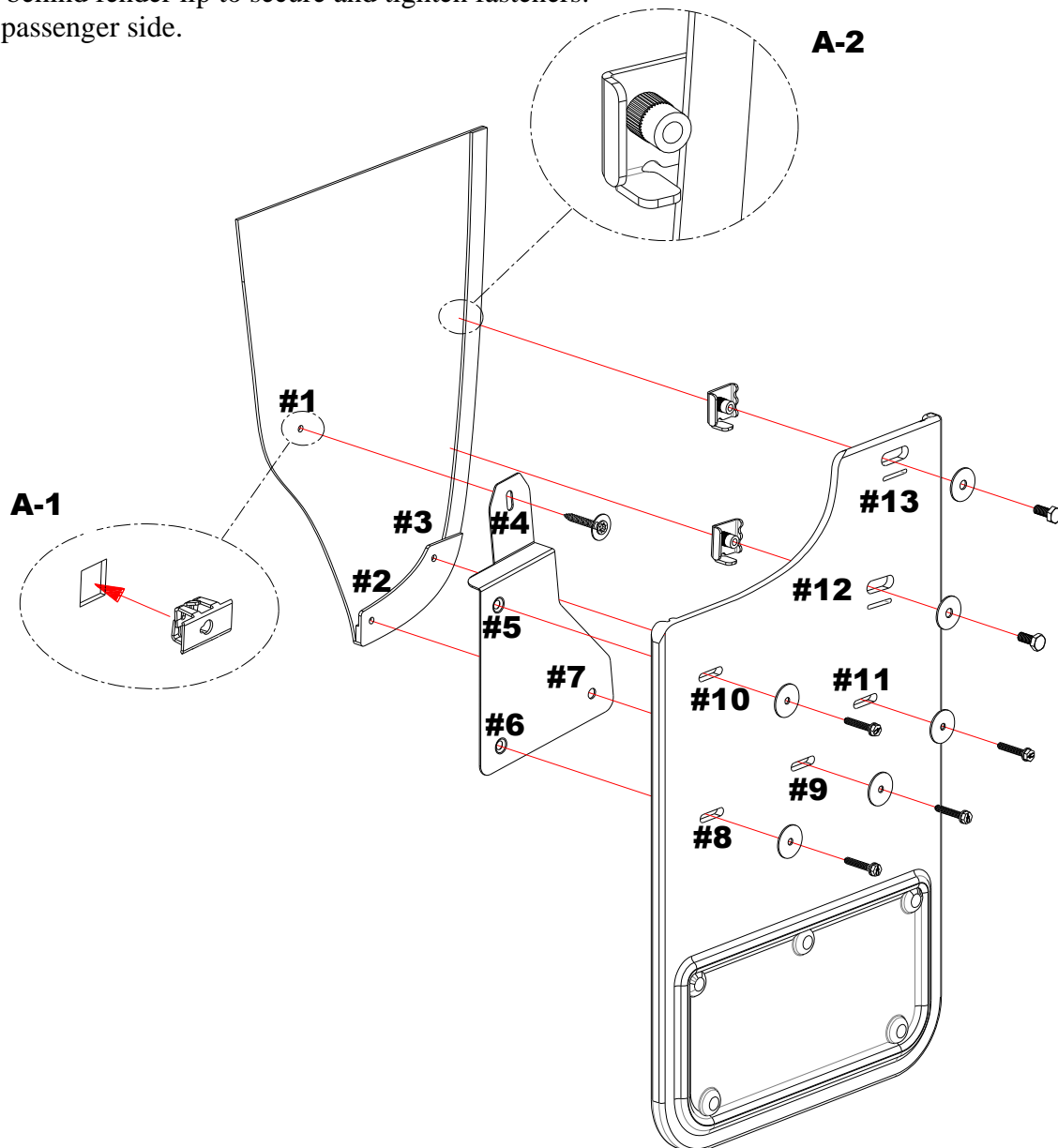

Please check out our YouTube channel to see an install video for this application.

