

RTS20CH/RTS21CH

MAGNUM RT STEPS

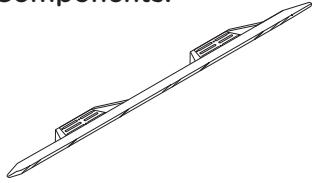

Components:



Passenger Side Step Bar Qty 1

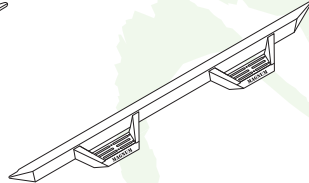

Driver Side Step Bar Qty 1

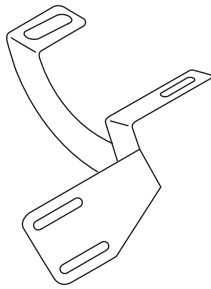

Passenger Side Front Mounting Bracket (Diesel Only) Qty 1

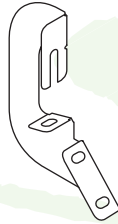

Driver Side Mounting Brackets Qty 4

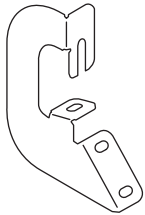

Passenger Side Mounting Brackets Qty 4



Passenger Side 2nd Location Top Mounting Bracket (17-C Diesel Only) Qty 1

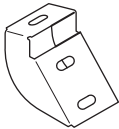

Passenger Side 2nd Location Bottom Mounting Bracket (17-C Diesel Only) Qty 1



Front Armor Plates Qty 2

Hardware:



M8 x 30 mm Hex Head Bolts Qty 24

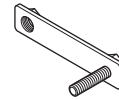

RTSPN175 Bolt/Nut Plates Qty 8



M8 Hex Head Nuts Qty 16



M8 Plastic Push Nuts Qty 8



M8 Flat Washers Qty 40



M8 Lock Washers Qty 32



M8 U-Nut Clips Qty 8



1/4" Spacer Qty 1

Tools Required:

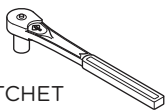

RATCHET



TORQUE WRENCH



13MM SOCKET

Torque Specifications:

For Rocker Panel Mount Installations
M8 through M12 bolts and nuts are set to 15-20 ft lbs.

Note: When installing the brackets and bars, all hardware must be left loose until all the items are attached.

1. Remove all contents from the package and check steps for any damage. Also, verify that all components and hardware listed above are included before you begin installation.

2. Read installation manual and installation drawing completely. Understand all brackets and bolts before installation.

3. Existing mounting holes are located on the interior wall of the rocker panel. These mounting holes will be used per the following instruction.

4. On driver side of vehicle, align Front, Center and Rear Brackets as shown.

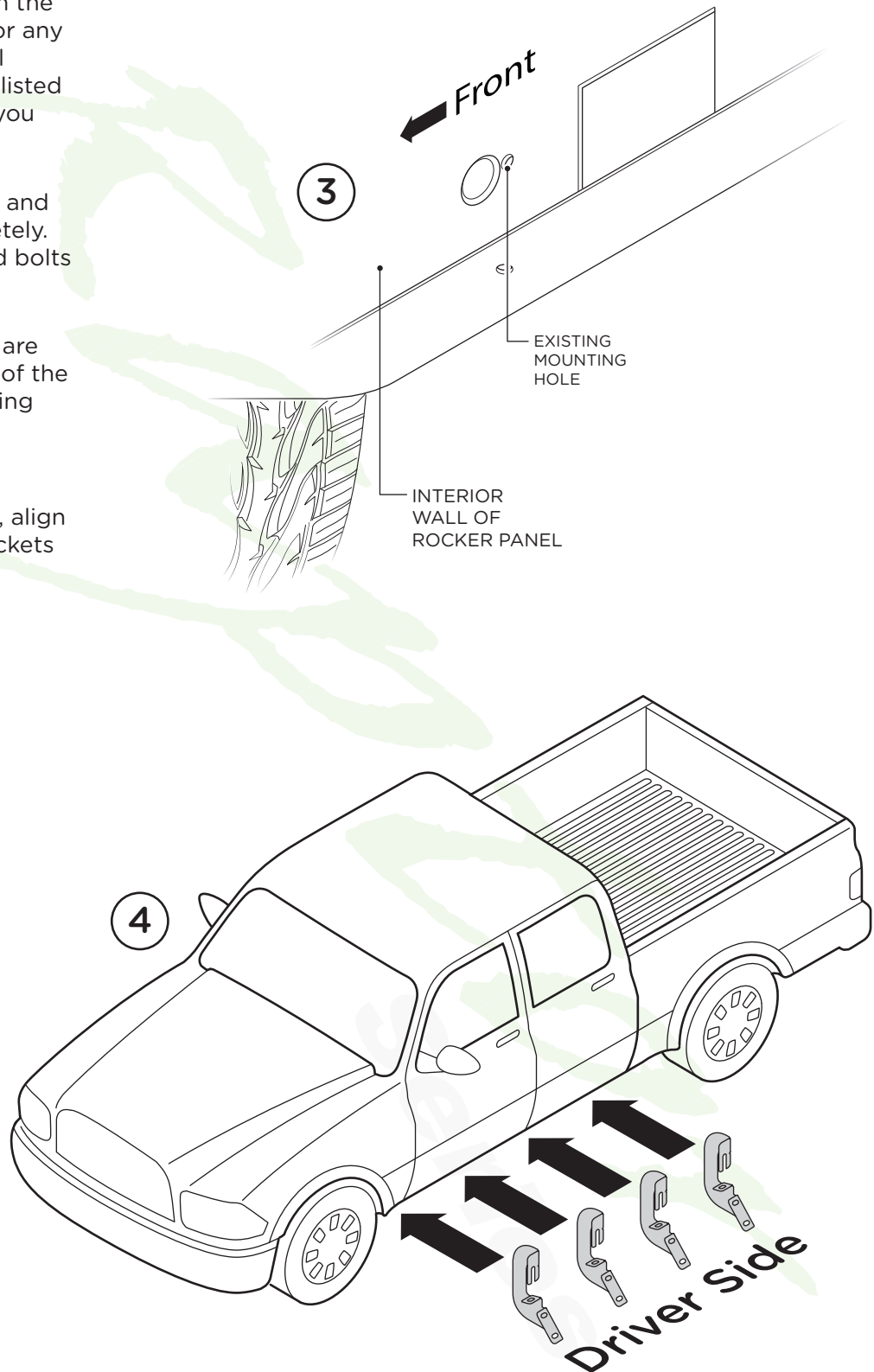

5. If specified holes in the wall of the rocker panel are not threaded, remove plastic plug (5a and 5b) and insert U-Nut Clip so that the threads are facing away from you (5c and 5d).

6. Fasten using one (1) M8 x 30 mm Hex Head Bolt, one (1) M8 Flat Washer and one (1) M8 Lock Washer (6a).

Complete installation of brackets by fastening the bracket to the pinch weld using one (1) M8 x 30 mm Hex Head Bolt, two (2) M8 Flat Washers, one (1) M8 Lock Washer and one (1) M8 Hex Head Nut (6b).

If installing on a gas model, mount passenger side brackets the same way as driver side. If installing on a diesel model with DEF tank, see next step.

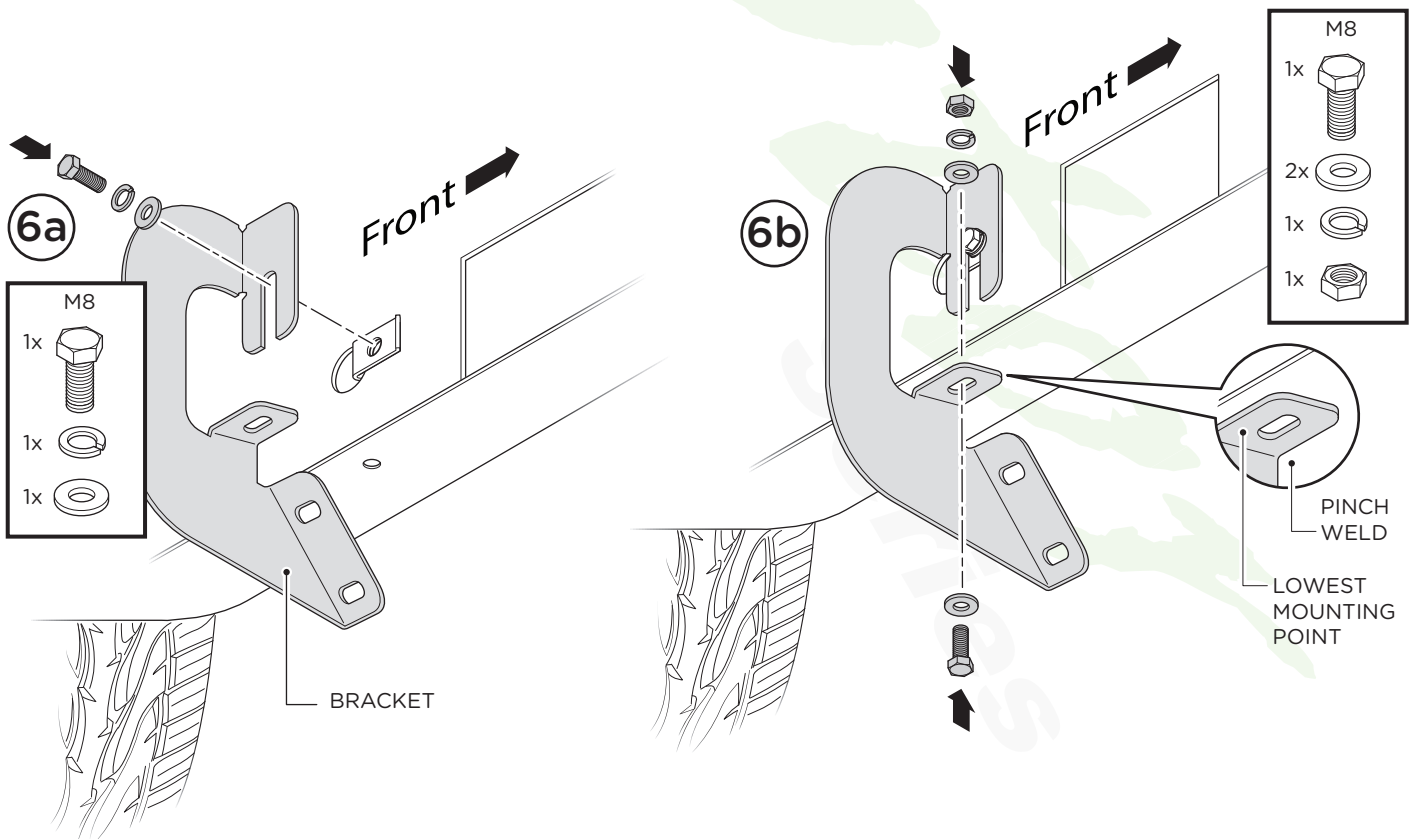
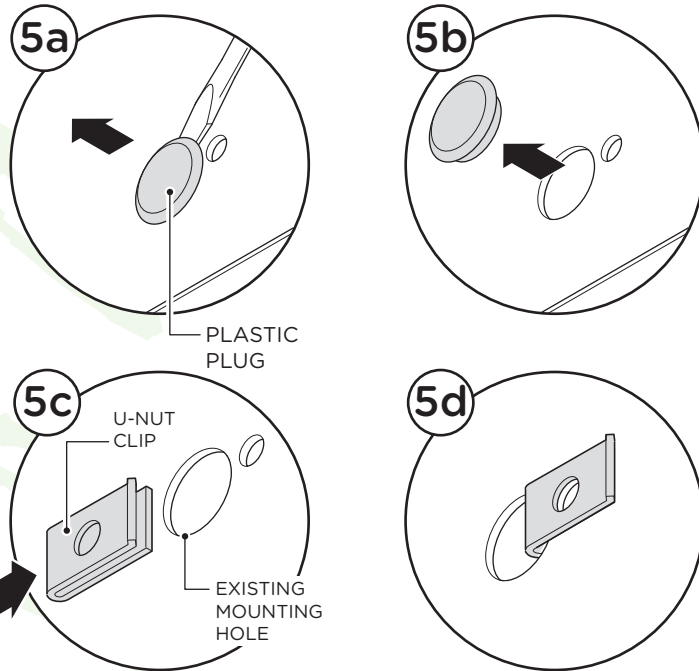

Installing on a Diesel Model with DEF Tank

7. If installing on a diesel model with DEF tank, you must use Passenger Side Front Mounting Bracket (Diesel Only) on the front mounting location.

Attach this bracket by removing the front body mount bolt (7a). Hold front bracket in place and keep the factory bushing in place while you reinstall the front cab mount bolt (7b).

The other mounting point on the bracket will line up with the factory threaded insert in the pinch weld. If there is already a bolt in the insert, please remove.

Fasten by using one (1) M8 x 30 mm Hex Head Bolt, one (1) M8 Lock Washer and one (1) M8 Flat Washer (7c).

If this mounting point does not fit flush with the pinch weld, insert the 1/4" spacer (7d) and fasten by using one (1) M8 x 30 mm Hex Head Bolt, one (1) M8 Lock Washer and one (1) M8 Flat Washer.

Note: 2014-2015 GMC Diesel trucks with factory fender flares will need to be trimmed to install Passenger Side Front Mounting Bracket (Diesel Only)

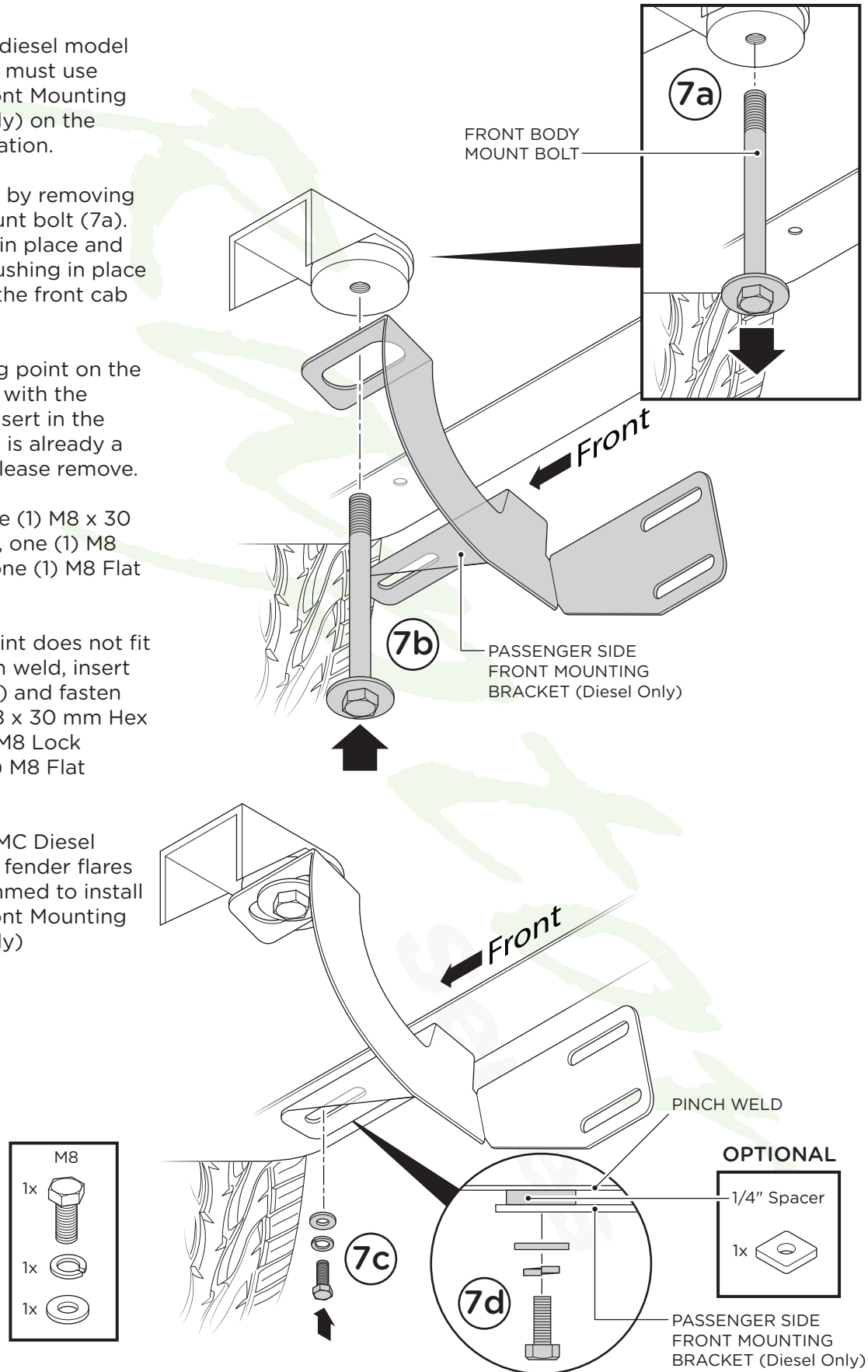

2017-C GM Diesel Trucks With DEF Tank

8. Since these trucks have a larger DEF tank, you must use Passenger Side 2nd Location Mounting Brackets (17-C Diesel Only) to mount the steps correctly.

Slide Passenger Side 2nd Location Top Mounting Bracket between the DEF tank and the rocker panel (8a).

The nut on this bracket will line up with the hole on the pinch weld and the vertical mounting point will be aligned with the threaded hole in the rocker panel (8b). If no threaded hole exists, please install M8 U-Nut Clip.

Fasten using one (1) M8x 30 mm Hex Head Bolt, one (1) M8 Lock Washer and one (1) M8 Flat Washer (8c).

Next, hold the Passenger Side 2nd Location Bottom Mounting Bracket to the bottom of the pinch weld and attach to Passenger Side 2nd Location Top Mounting Bracket using one (1) M8x 30 mm Hex Head Bolt, one (1) M8 Lock Washer and one (1) M8 Flat Washer (8d).

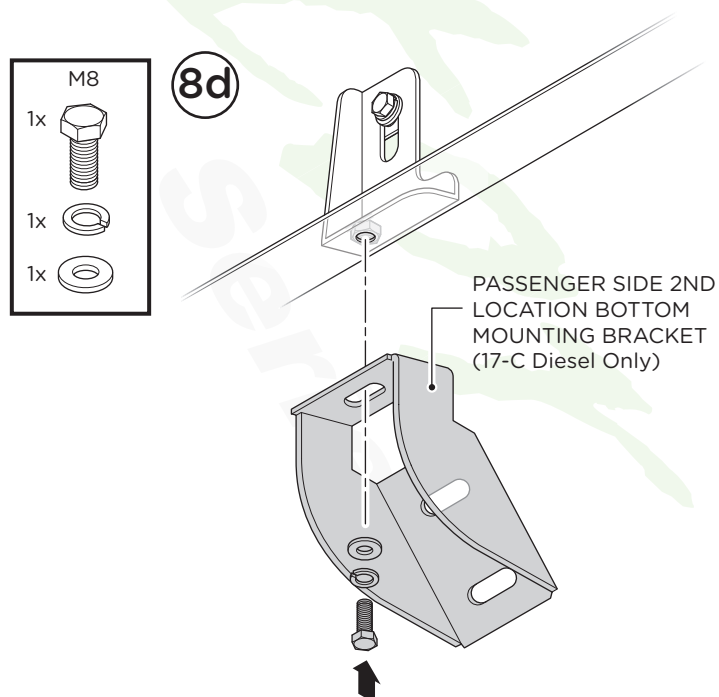
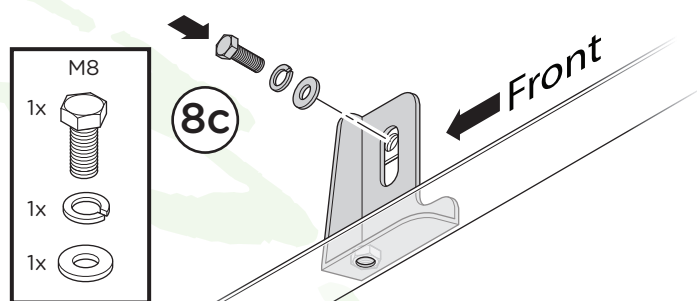
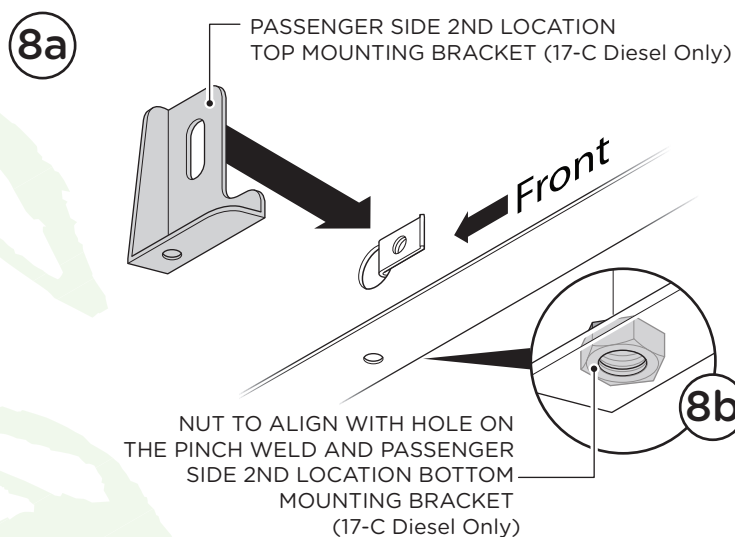

Installing the Step Bar

9. Line up mounting points on the step bar with the mounting holes in each bracket.

10. Fasten the step bar to each bracket using one (1) RTSPN175 Bolt/Nut Plate, one (1) Plastic Push Nut, one (1) M8 Hex Head Nut, two (2) M8 Lock Washers, two (2) M8 Flat Washers and one (1) M8 x 30MM Hex Head Bolt.

11. Adjust the bars front/back and up/down to desired placement. Once you have the step positioned, tighten until the split lock washer is flat between the bolt head and flat washer. Do not over tighten.

12. When all hardware is in place, everything must be tightened. See page 1 for torque specifications. Repeat these steps for opposite side installation.

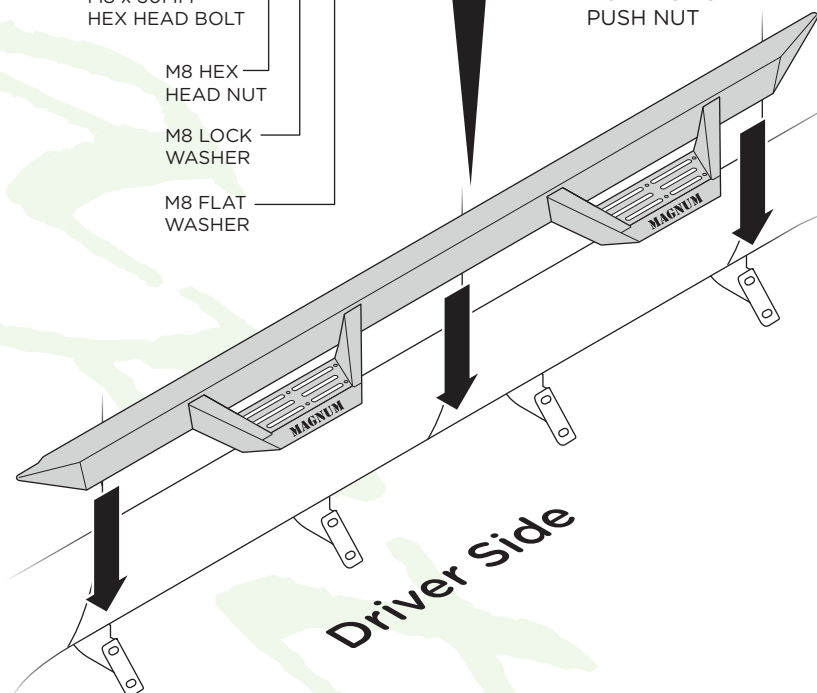
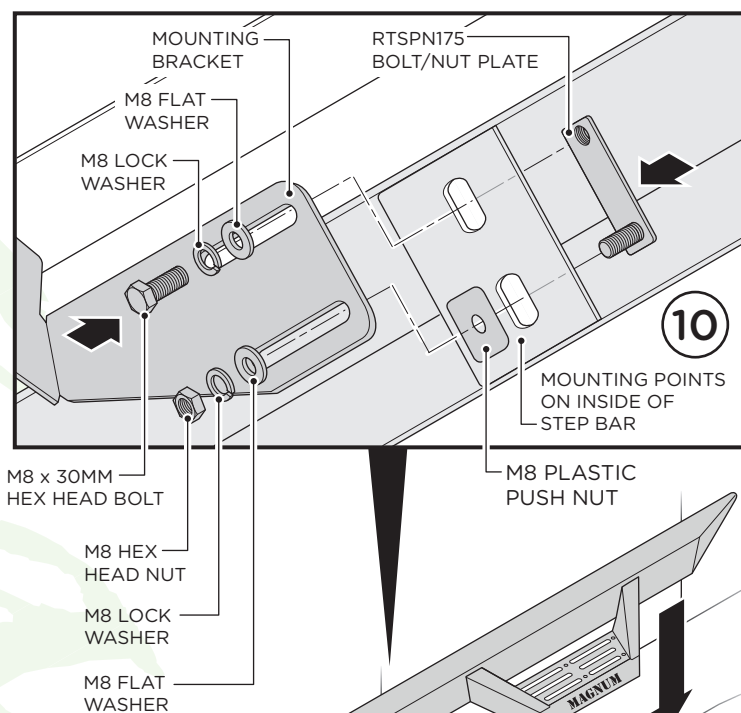

OPTIONAL:

If you wish to install the Front Armor Plates, begin by thoroughly cleaning the front side of the front step where the Front Armor Plate will attach.

1. Remove adhesive protection from the Front Armor Plate.

2. Carefully line up with the front side of the front step. Be careful not to let the side overhang as they could peel off over time.

Once lined up, firmly press the Front Armor Plate on the step to ensure complete adhesion.

Repeat these steps for opposite side.

