

RTS64FD/RTS81FD

MAGNUM RT STEPS

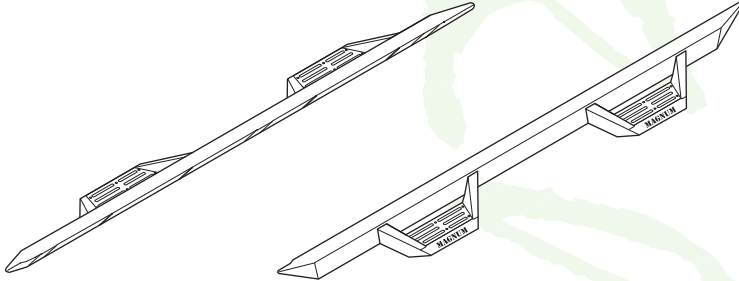

Components:



Passenger Side Step Bar Qty 1

Driver Side Step Bar Qty 1

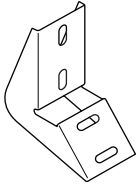

Mounting Brackets Qty 6



Front Armor Plates Qty 2

Hardware:



M8 x 30 mm Hex Head Bolts Qty 18

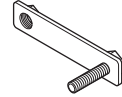

RTSPN175 Bolt/Nut Plates Qty 6



M8 Hex Head Nuts Qty 12



M8 Plastic Push Nuts Qty 6



M8 Flat Washers Qty 30



M8 Lock Washers Qty 24



M8 U-Nut Clips Qty 6

Tools Required:

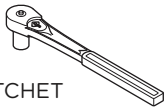

RATCHET

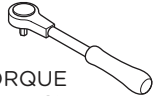

TORQUE WRENCH



13MM SOCKET

Torque Specifications:

For Rocker Panel Mount Installations
M8 through M12 bolts and nuts are set to 15-20 ft lbs.

Note: When installing the brackets and bars, all hardware must be left loose until all the items are attached.

1. Remove all contents from the package and check steps for any damage. Also, verify that all components and hardware listed above are included before you begin installation.
2. Remove the black tape and large rubber grommets over the mounting holes located on the inside face of the rocker panel.
3. Existing mounting holes are located on the interior wall of the rocker panel. These mounting holes will be used per the following instruction.

Begin by identifying the correct location for each of the M8 U-Nut Clips. See diagram for pinch weld and rocker panel hole locations

Inside Rocker Locations for Ford Superduty

Looking at the pinch weld there are 10 holes long the length of the cab. The brackets will mount into the 2nd, 6th and 9th holes. Spacing between these holes is shown below.

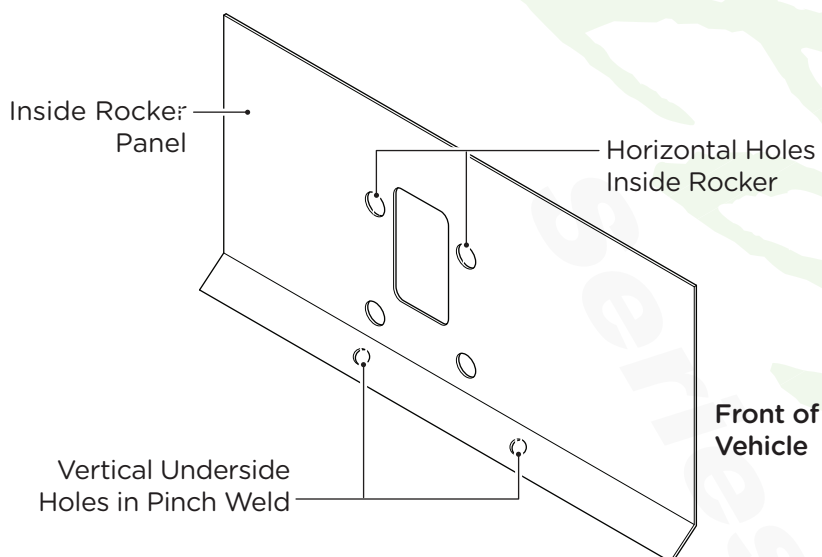
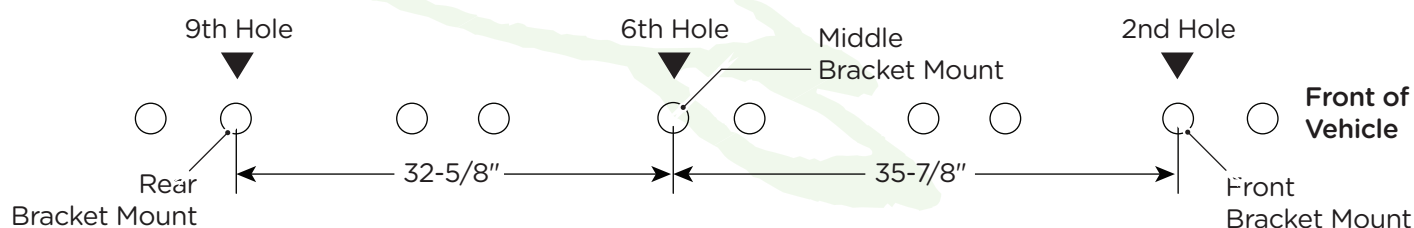

4. Install U Nut Clips so that the threads are to the inside of the rocker panel. Be careful not to drop the U Nut Clips inside of the rocker panel.

5. On the driver side of the vehicle, align Mounting Brackets as shown.

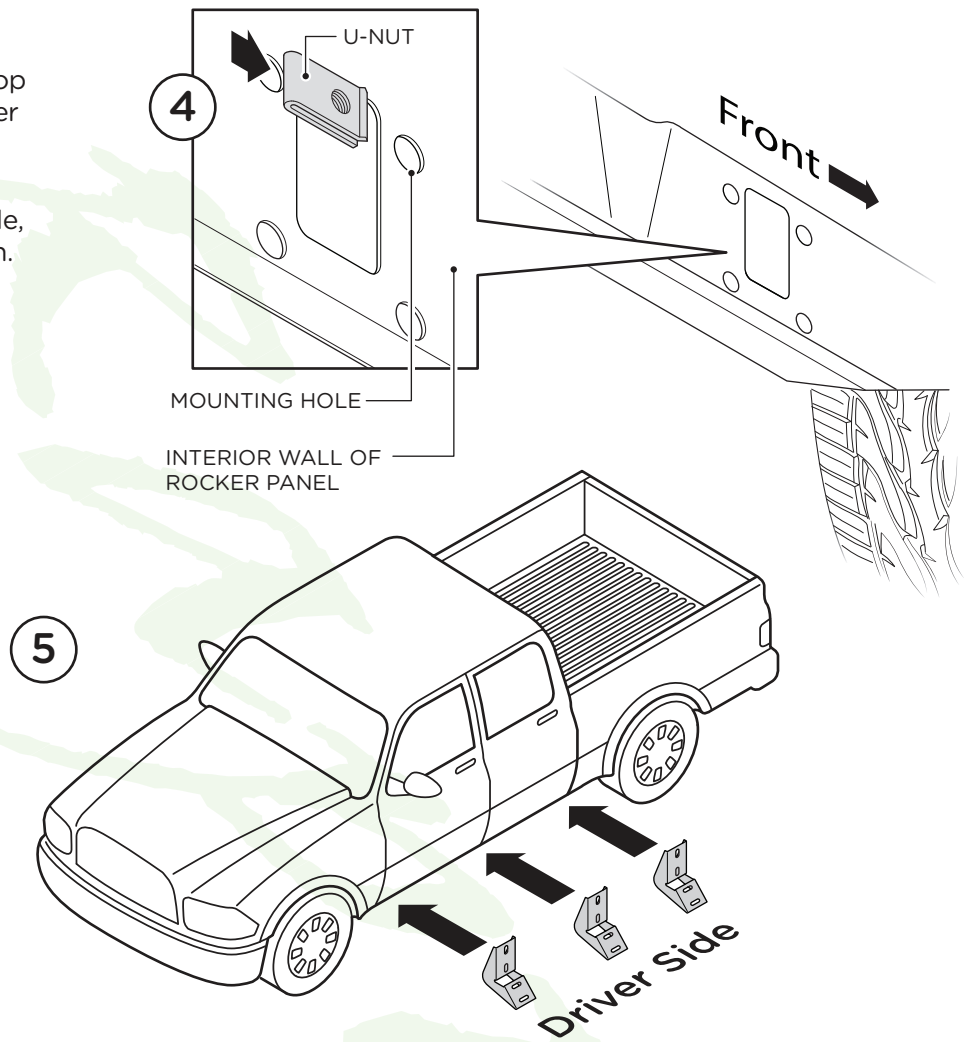

Installing the Brackets

6. Install each bracket to M8 U-Nut Clip using each bracket to the rocker panel using one (1) M8 Hex Head Bolt, one (1) M8 Lock Washer and one (1) M8 Flat Washer per bracket (6a).

Attach lower portion of each bracket to the rocker panel using one (1) M8 Hex Head Bolt, one (1) M8 Lock Washer, two (2) M8 Flat Washers and one (1) M8 Hex Head Nut.

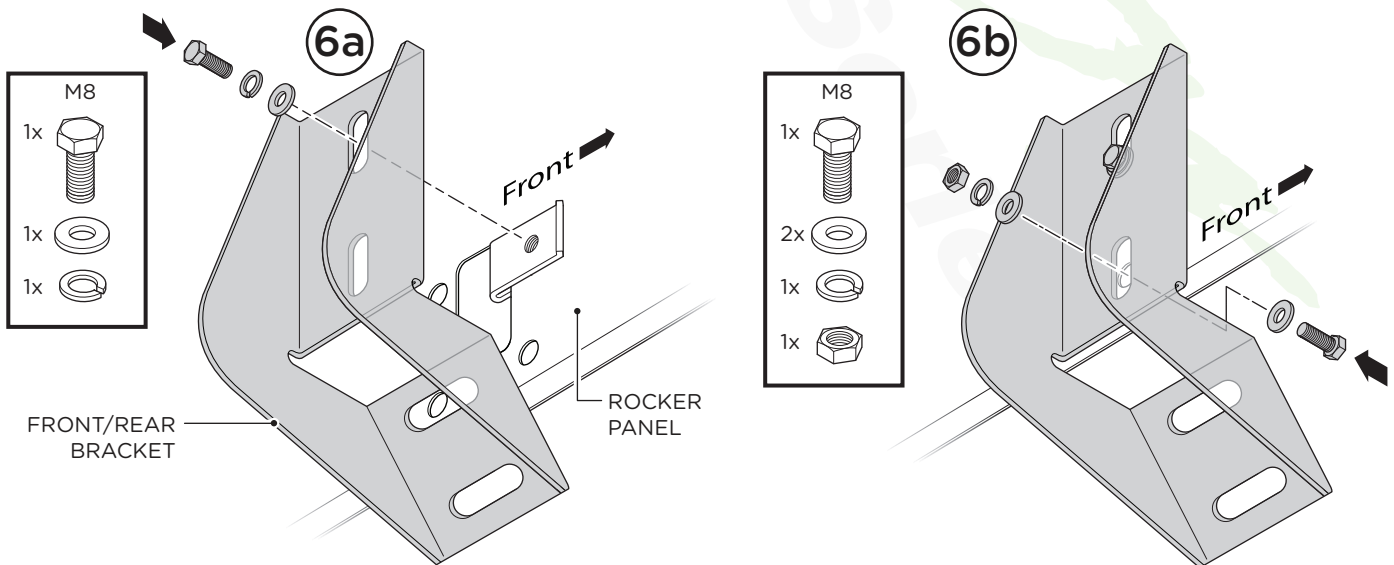

Installing the Step Bar

7. Line up mounting points on the step bar with the mounting holes in each bracket.

8. Fasten the step bar to each bracket using one (1) RTSPN175 Bolt/Nut Plate, one (1) Plastic Push Nut, one (1) M8 Hex Head Nut, two (2) M8 Lock Washers, two (2) M8 Flat Washers and one (1) M8 x 30MM Hex Head Bolt.

9. Adjust the bars front/back and up/down to desired placement. Once you have the step positioned, tighten until the split lock washer is flat between the bolt head and flat washer. Do not over tighten.

10. When all hardware is in place, everything must be tightened. See page 1 for torque specifications. Repeat these steps for opposite side installation.

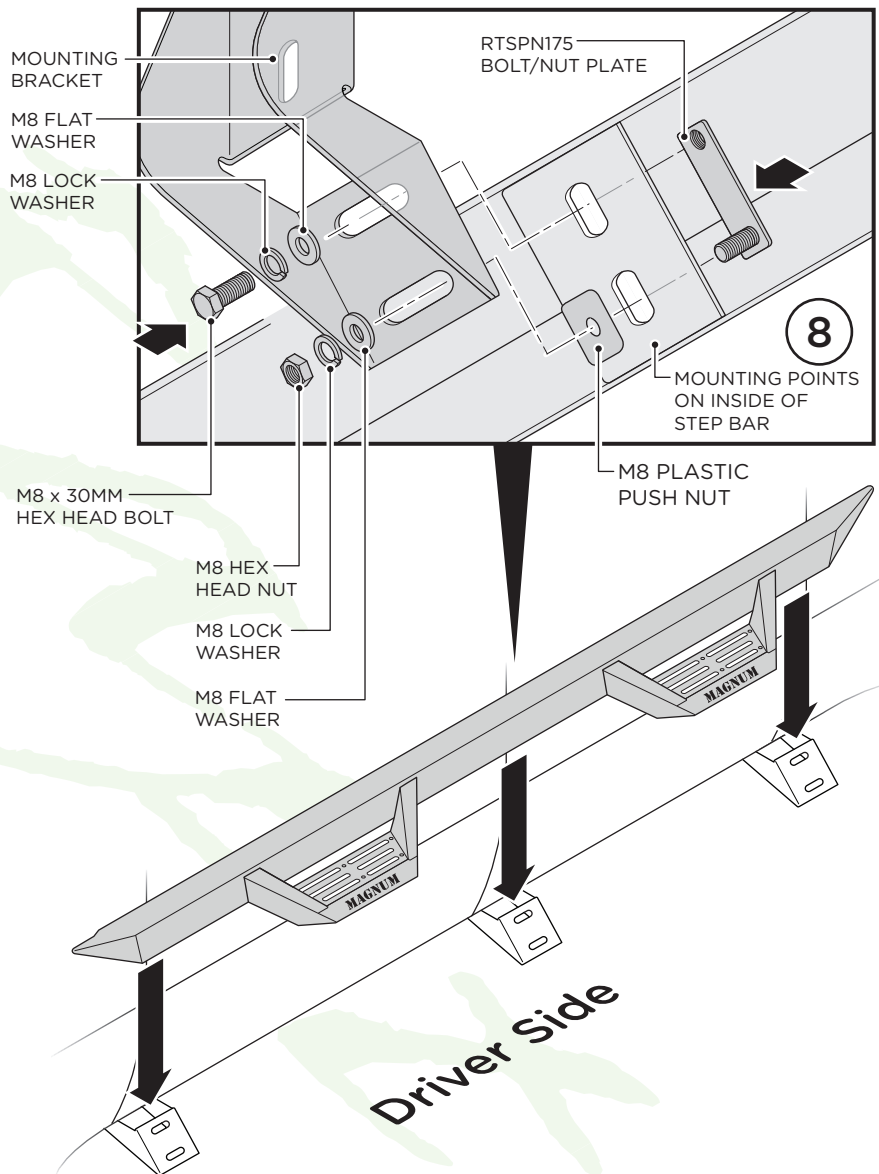

OPTIONAL:

If you wish to install the Front Armor Plates, begin by thoroughly cleaning the front side of the front step where the Front Armor Plate will attach.

1. Remove adhesive protection from the Front Armor Plate.

2. Carefully line up with the front side of the front step. Be careful not to let the side overhang as they could peel off over time.

Once lined up, firmly press the Front Armor Plate on the step to ensure complete adhesion.

Repeat these steps for opposite side.

