

RTS79DG/RTS82DG/RTS96DG

MAGNUM RT STEPS

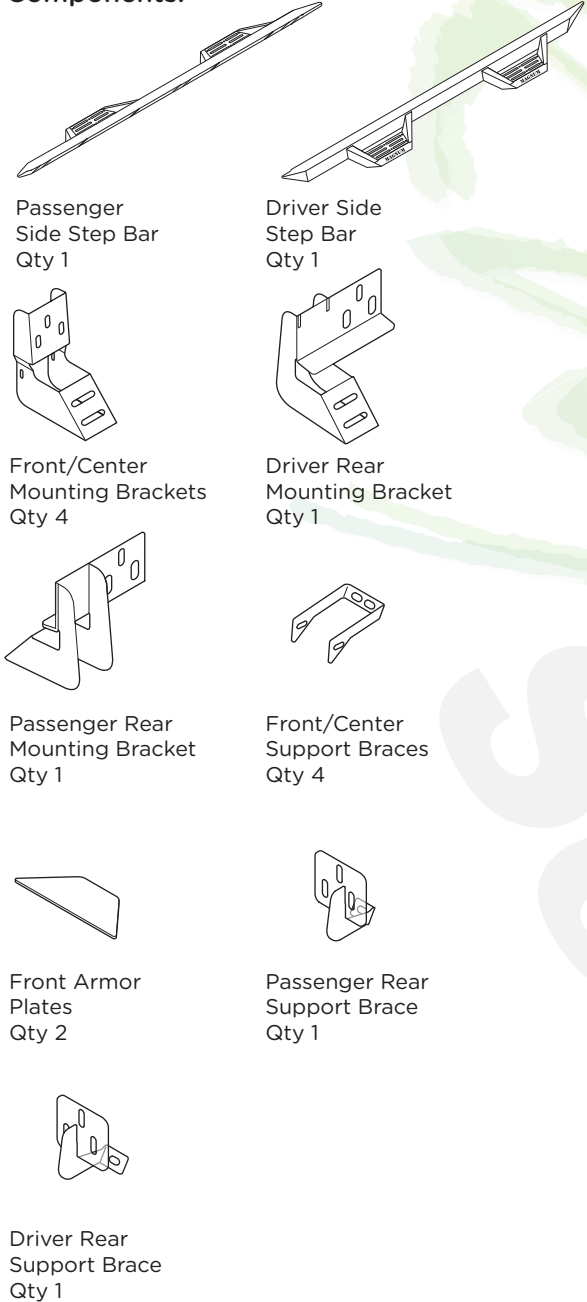

Components:



Hardware:

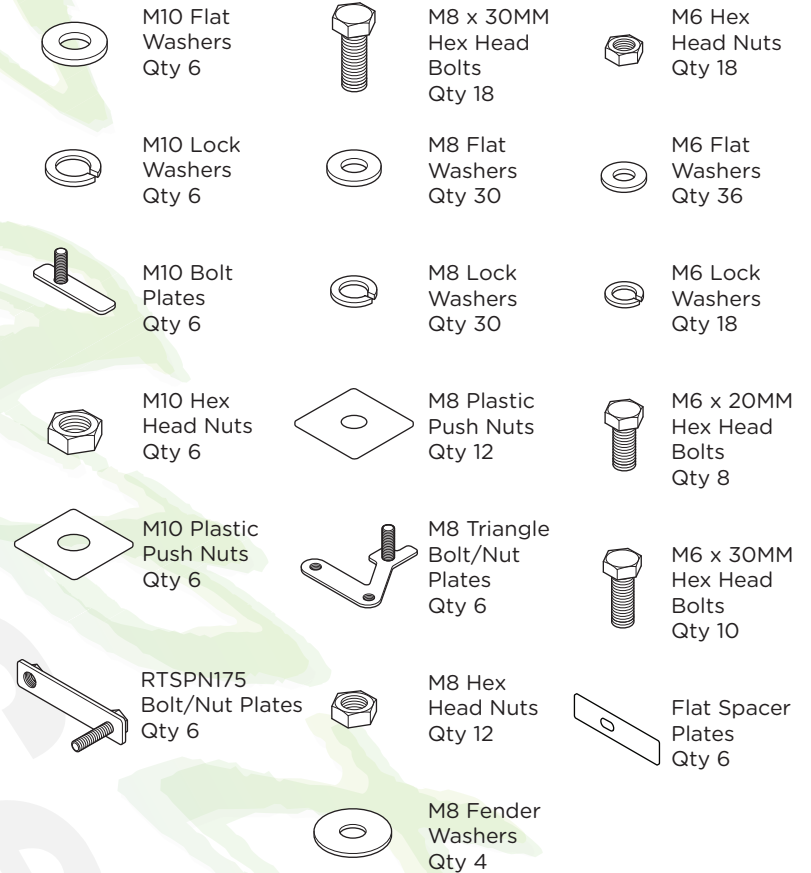

Tools Required:



Torque Specifications:

For Rocker Panel Mount Installations
 M8 through M12 bolts and nuts are set to 15-20 ft lbs.

Note: When installing the brackets and bars, all hardware must be left loose until all the items are attached.

1. Remove all contents from the package and check steps for any damage. Also, verify that all components and hardware listed above are included before you begin installation.

2. Locate factory holes in six (6) places on the rocker panel.

Note: Ram trucks built after June 1st 2015 may be equipped with a factory reinforcement bracket attached to the inside of the rocker panel. This will need to be removed prior to installation.

Remove all three factory mounting bolts and wire harness held in place with plastic retaining clips and remove bracket from vehicle. Mounting Brackets will serve as the reinforcement to the rocker panel.

3. Remove the tape covering the factory oblong hole in the Rocker Panel located above the two (2) hex holes.

Determine if your truck has threaded inserts in the rocker panel. These holes are located just underneath of the oblong factory hole.

4. If your truck is equipped with the threaded inserts, you will install the Single M10 Bolt Plate.

If your truck is NOT equipped with the threaded inserts, you will install the M8 Triangle Bolt/Nut Plate.

Install the M10 Plastic Push Nut onto the Single M10 Bolt Plate (4a) or the M8 Plastic Push Nut onto the M8 Triangle Bolt/Nut Plate (4b) to ensure it does not fall into the rocker panel during installation.

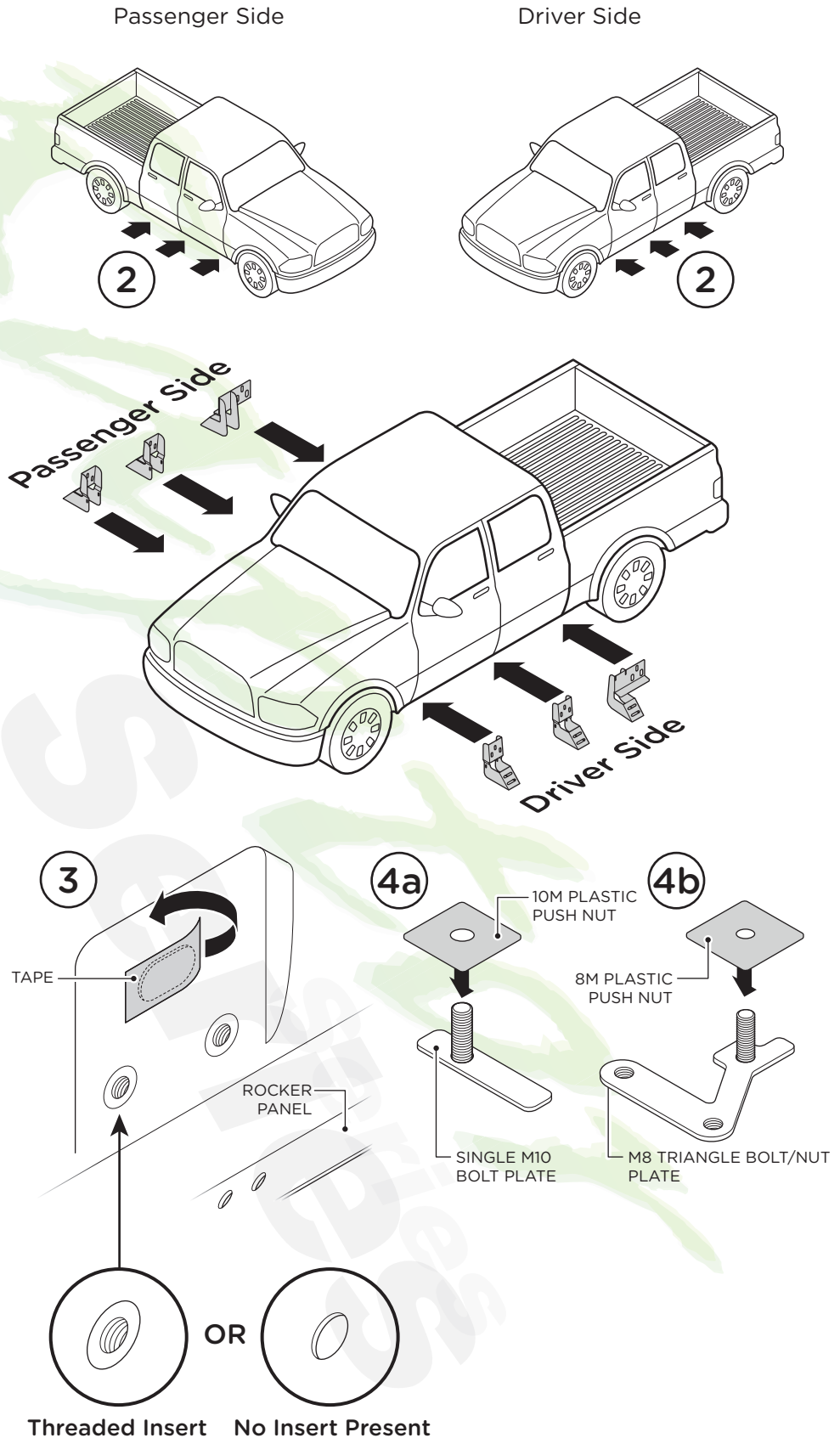

5. Insert either Single M10 Bolt Plate or M8 Triangle Bolt/Nut Plate into the oblong factory hole (5a) with the threaded stud sticking out of the oblong factory hole (5b).

Note: If your threaded holes do not sit flush with the outside of the rocker panel, you must use one (1) Flat Spacer Plate installed over the M10 Stud to ensure the bracket is level with the rocker panel.

M10 Single Bolt Plate

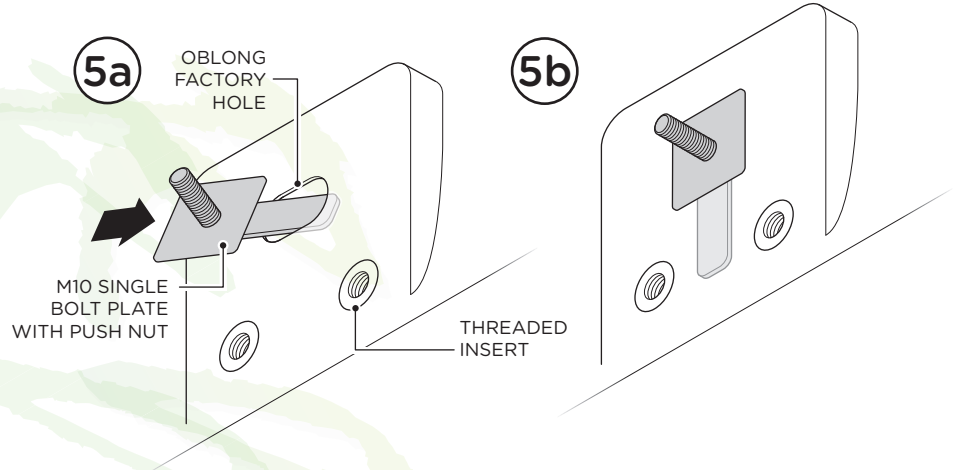

Installing Front/Center Mounting Brackets

6a. Attach the top mounting point of Front/Center Mounting Brackets to the vehicle using M8 or M10 hardware depending on bolt plate used. You will use one (1) Flat Washer, one (1) Lock Washer and one (1) Hex Head Nut.

6b. Attach the lower mounting points of Front/Center Mounting Brackets to the vehicle by using two (2) M8 Hex Head Bolts, two (2) M8 Lock Washers and two (2) M8 Flat Washers.

M8 Triangle Bolt/Nut Plate

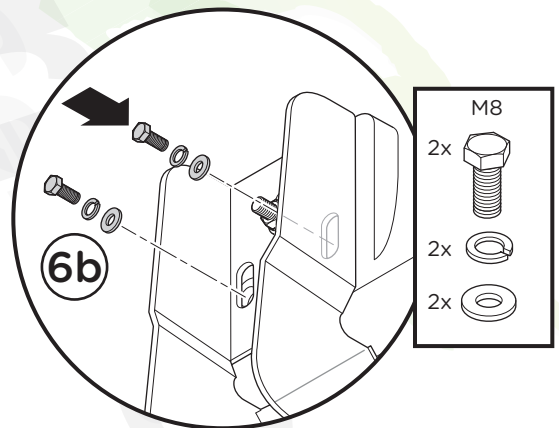
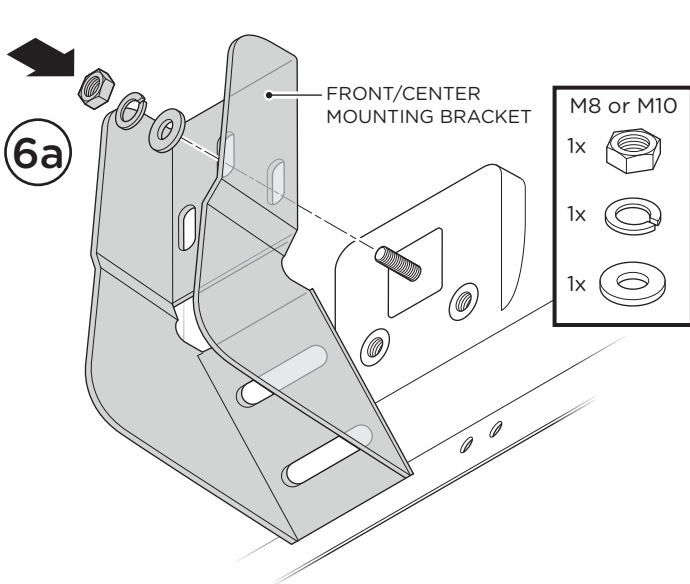
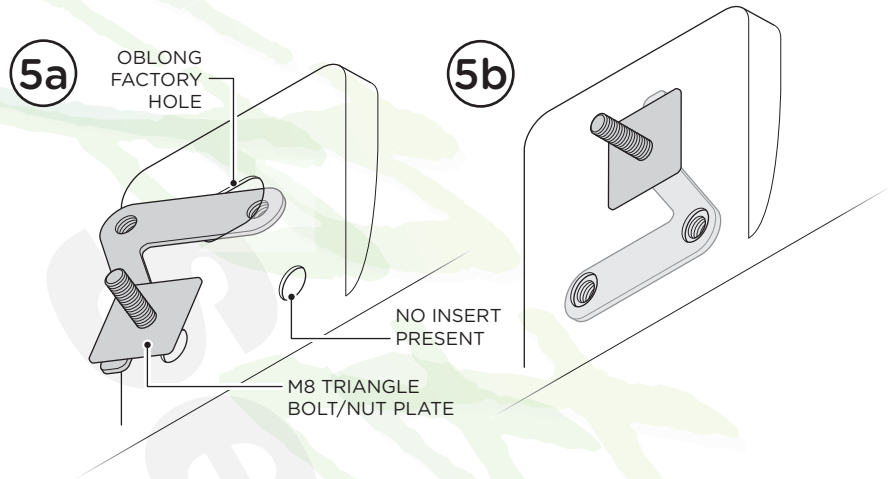

Installing Rear Mounting Bracket

7a. If installing Rear Mounting Bracket **WITHOUT** Rear Support Brace, attach the top mounting point of Rear Mounting Bracket to the vehicle using M8 or M10 hardware depending on bolt plate used. You will use one (1) Flat Washer, one (1) Lock Washer and one (1) Hex Head Nut.

7b. Attach the lower mounting point of Rear Mounting Bracket to the vehicle by using two (2) M8 Hex Head Bolts, two (2) M8 Lock Washers and two (2) M8 Fender Washers. These washers are larger to use with larger bracket holes.

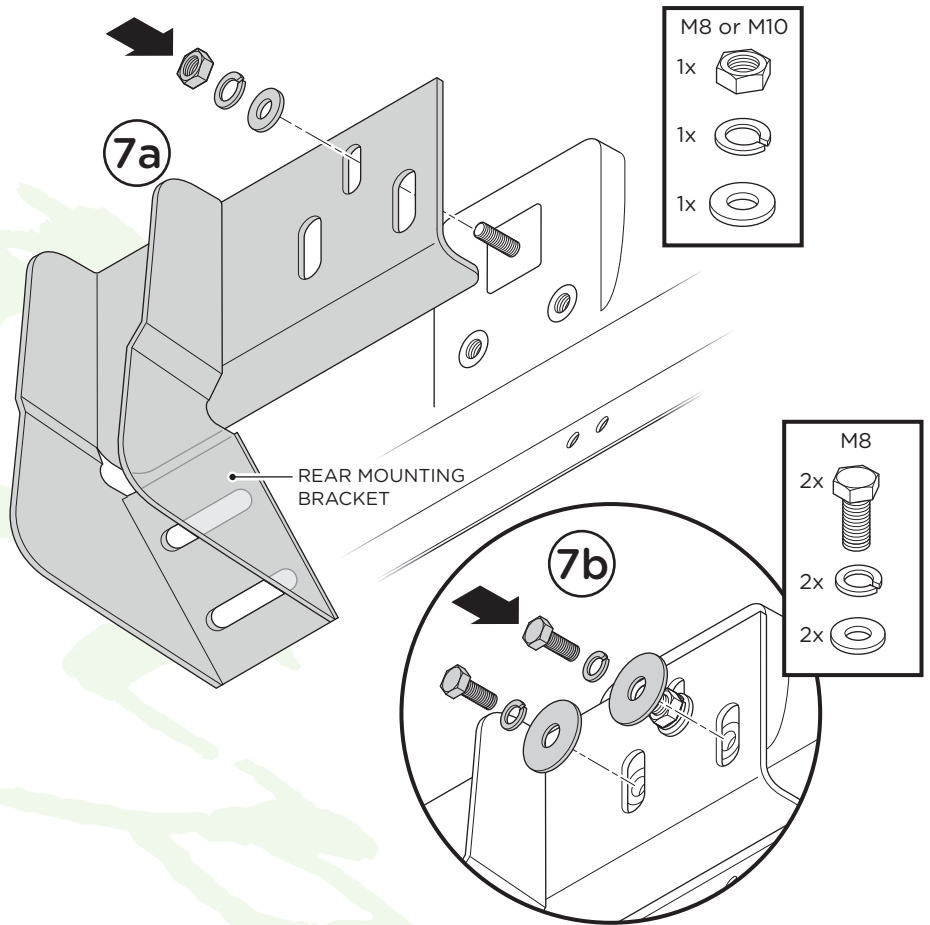

8a. If installing Rear Mounting Bracket **WITH** Rear Support Brace, position Rear Support Brace over the Rear Mounting Bracket and attach the top mounting point to the vehicle using M8 or M10 hardware depending on bolt plate used. You will use one (1) Flat Washer, one (1) Lock Washer and one (1) Hex Head Nut.

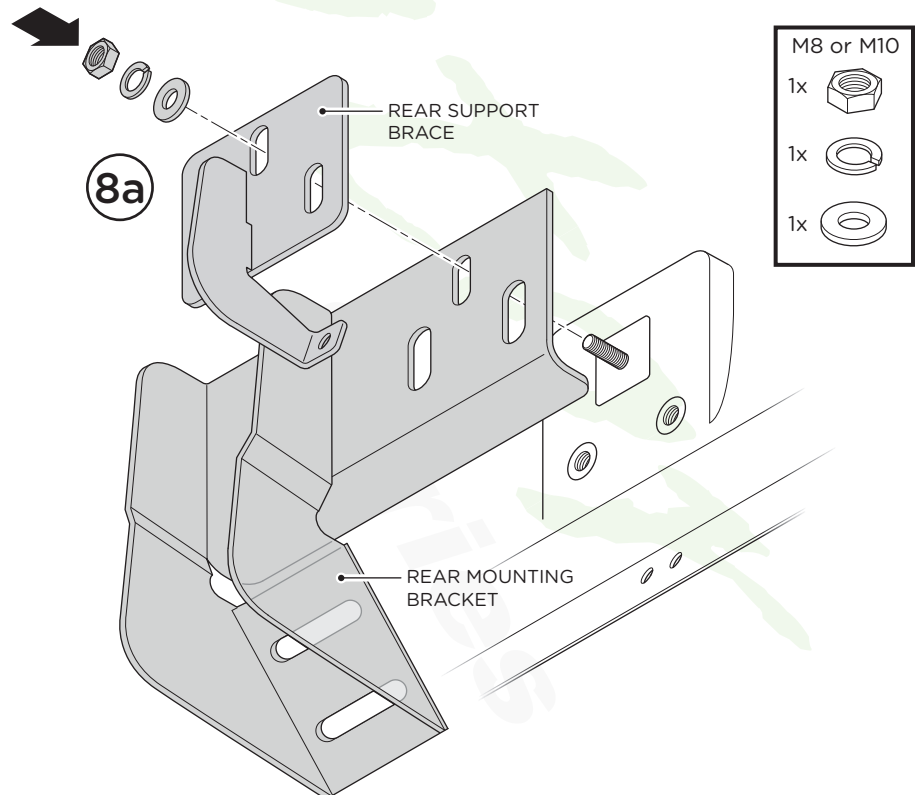

8b. Attach the lower mounting points of Rear Mounting Bracket to the vehicle by using two (2) M8 Hex Head Bolts, two (2) M8 Lock Washers and two (2) M8 Flat Washers.

8c. Attach the Rear Support Brace to the pinch weld by using one (1) M6x30MM Hex Head Bolt, one (1) M6 Lock Washer and two (2) M6 Flat Washers.

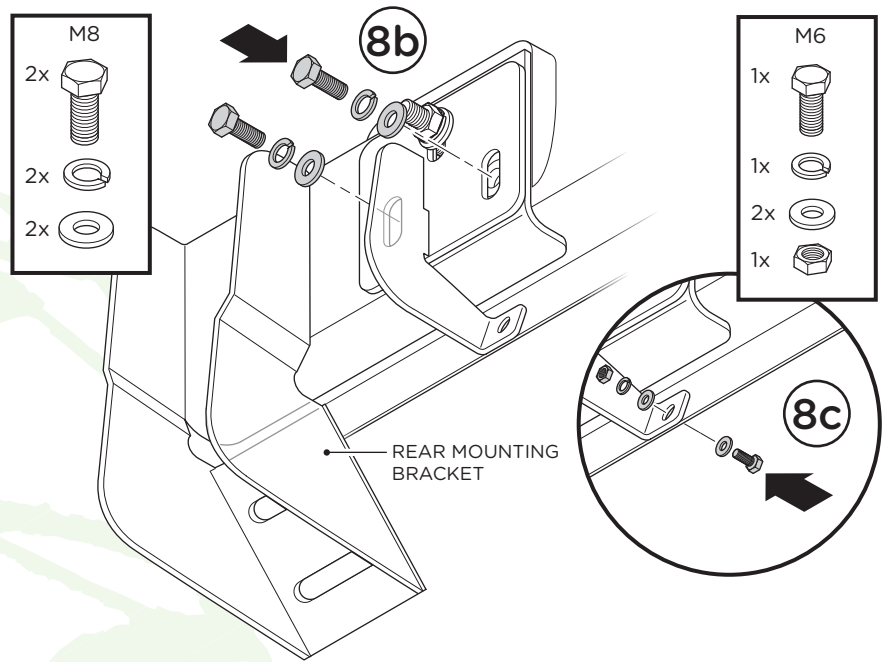

Installing Front/Center Support Braces

9. Line up Front/Center Support Braces with the holes in the Front/Center Mounting Brackets as well as the pre-drilled holes in the pinch weld of the truck.

Attach the Front/Center Support Braces to the pinch weld by using two (2) M6x30MM Hex Head Bolts, two (2) M6 Lock Washers, four (4) M6 Flat Washers and two (2) M6 Hex Nuts.

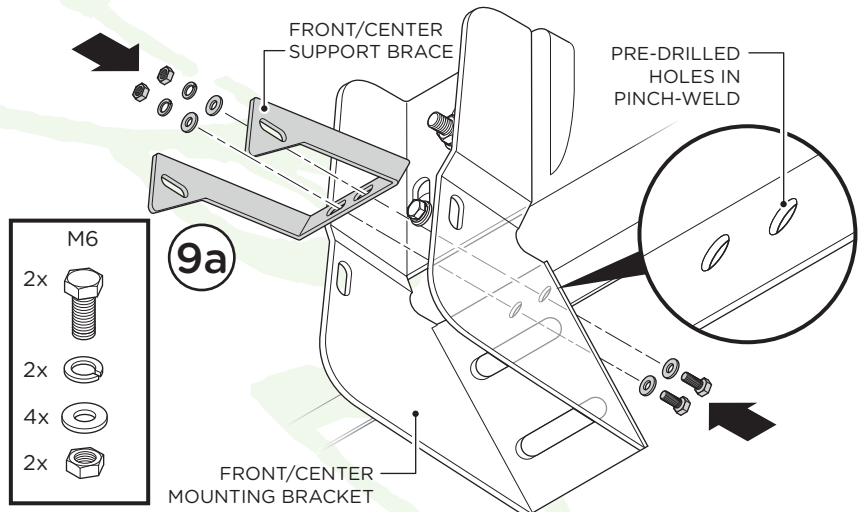

9b. Attach Front/Center Support Braces to the Brackets using two (2) M6x20MM Hex Head Bolts, two (2) M6 Lock Washers, four (4) M6 Flat Washers and two (2) M6 Hex Head Nuts.

Note: If holes do not exist in pinch weld, you may drill these using a 1/4" drill bit. This is not required but installing support braces will greatly reduce rocker panel flex.

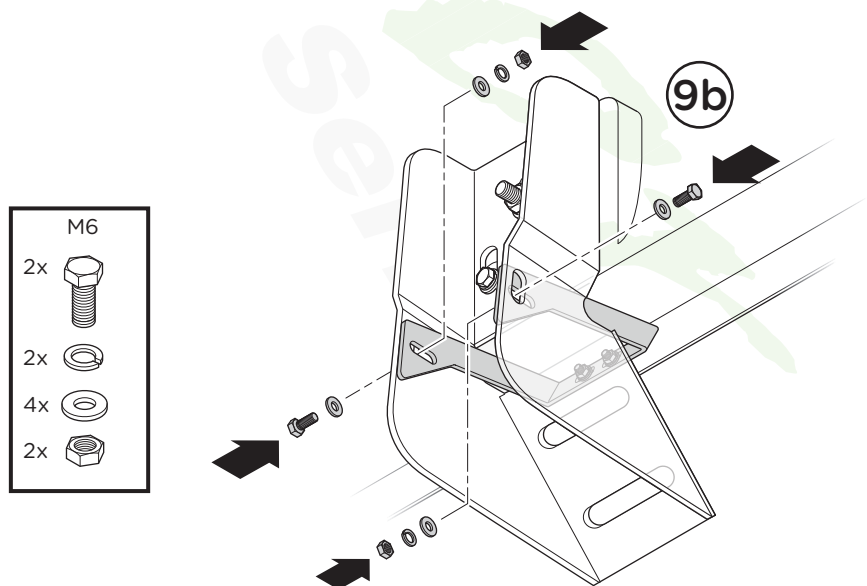

Installing the Step Bar

10. Line up mounting points on the step bar with the mounting holes in each bracket.

Fasten the step bar to each bracket using one (1) RTSPN175 Bolt/Nut Plate, one (1) Plastic Push Nut, one (1) M8 Hex Head Nut, two (2) M8 Lock Washers, two (2) M8 Flat Washers and one (1) M8 x 30MM Hex Head Bolt.

Adjust the bars front/back and up/down to desired placement. Once you have the step positioned, tighten until the split lock washer is flat between the bolt head and flat washer. Do not over tighten.

When all hardware is in place, everything must be tightened. See page 1 for torque specifications. Repeat these steps for opposite side installation.

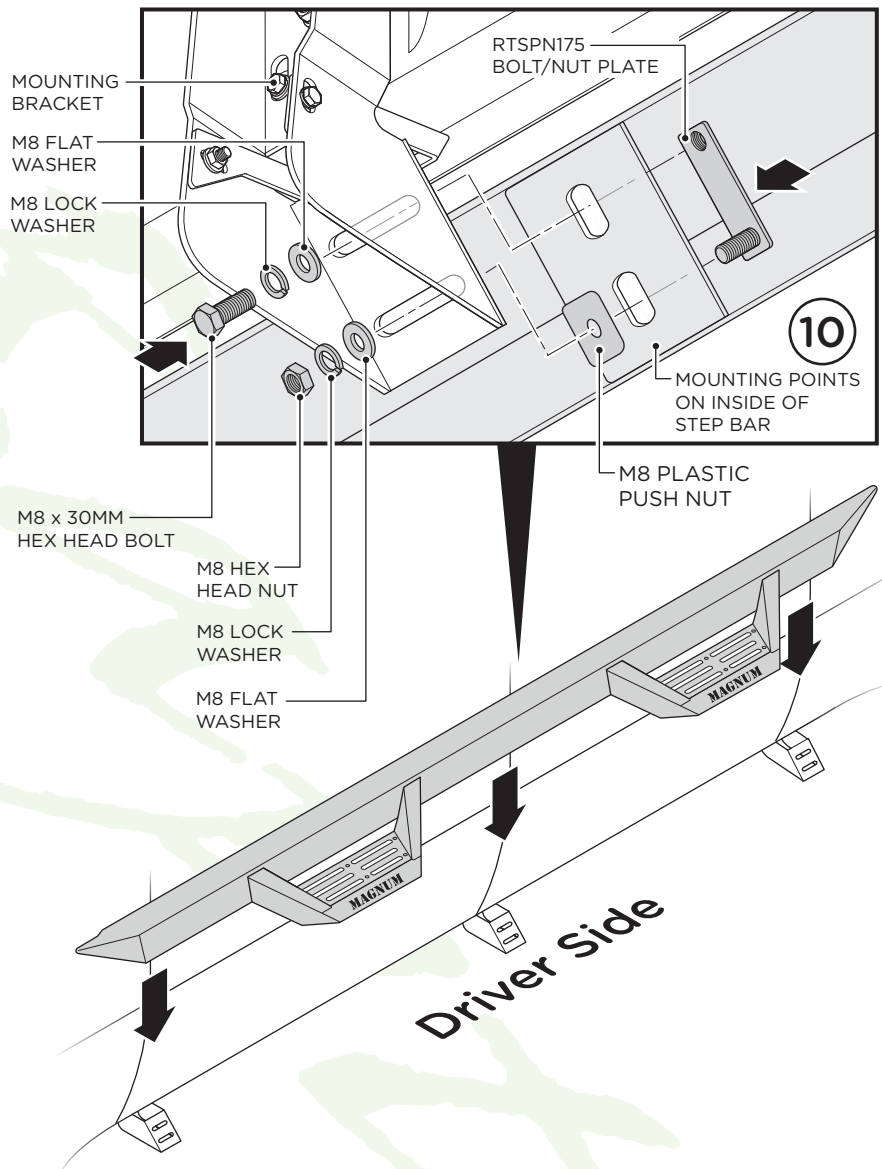

OPTIONAL:

If you wish to install the Front Armor Plates, begin by thoroughly cleaning the front side of the front step where the Front Armor Plate will attach.

1. Remove adhesive protection from the Front Armor Plate.

2. Carefully line up with the front side of the front step. Be careful not to let the side overhang as they could peel off over time.

Once lined up, firmly press the Front Armor Plate on the step to ensure complete adhesion.

Repeat these steps for opposite side.

