

766164/766303/766316/766319/
766325/766328/766331

IMPORTANT

The manufacturer is not responsible for negligent use of vehicle with mudflaps installed, including over-tightening of screws and bolts causing damage to vehicle or mudflaps.

TOOLS REQUIRED:

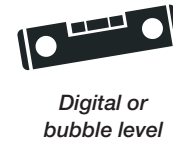
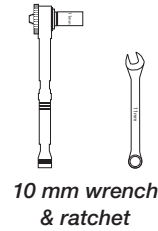
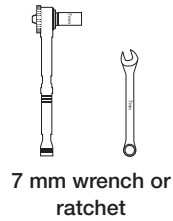

PARTS:

1. (2) Gatorback CR
Mud Flap (DS & PS)

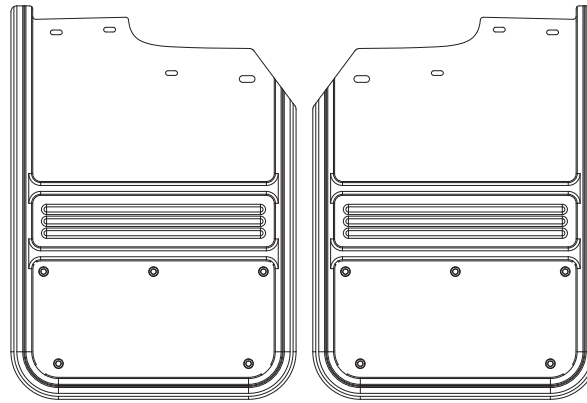

2. (2) Washer Plate
(DS & PS)
Part# 759955

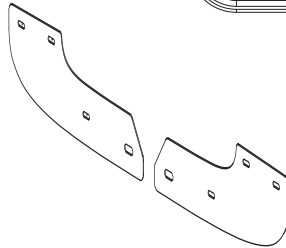

3. (2) Brace
(DS & PS)
Part# 759953
759954

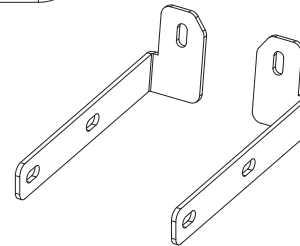

FASTENERS:

4. (8) Black Nylon Washer
0.265" ID 0.625" OD
Part# 054071

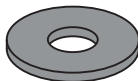

5. (2) SS Cap Screw
M6 x 35 mm
Part# 012028



6. (2) Aluminum Washer
0.281" ID 1" OD
Part# 018052



7. (2) SS
Lock Washer
M6
Part# 024000



8. (2) SS
Hex Nut
M6
Part# 025022



9. (4) SS
Serrated
Flange Nut
M6
Part# 025025



10. (6) Existing Black
Factory Screws
#8 x 34mm



INSTALLATION:

Note: Please refer to diagram during installation. Power tools not recommended.

1. REMOVE FACTORY FRONT SPLASH GUARD (DS)

- Remove 4x Factory Screws (#10) and 1x plastic push pin securing factory splash guard.
- Retain 3x Factory Screws (#10) for next step. You may reinstall push pin and fourth factory screw on bottom of fender flare.

2. INSTALL MUD FLAP (DS) AND WASHER PLATE (DS)

- Loosely install Gatorback CR Mud Flap (#1) using Washer Plate (#2) using 3x Factory Screws (#10) and 3x Nylon Washers (#4).

3. INSTALL BRACE (DS)

- Locate two factory fender bolts on underside of truck body, directly behind wheel opening.
- Loosely install Brace (#3) using 2x M6 Serrated Flange Nuts (#9). Threads may need to be cleaned of any paint residue.
- Loosely attach Brace (#3) to Mud Flap (#1) using 1x 1/4" Cap Screw (#5), 1x Nylon Washer (#4), 1x Aluminum Washer (#6), 1x Lock Washer (#7), and 1x Hex Nut (#8).

4. ADJUST MUD FLAP POSITION AND ALIGNMENT

- Adjust horizontal position of mud flap (#1).
- With a level (bubble/digital) on the bottom edge of the Mud Flap (#1), adjust until level.
- Carefully tighten 3x factory screws, and double check that Mud Flap (#1) is still level.
- Adjust forward-back position of Brace so that Mud Flap (#1) is approximately parallel to tire tread.

5. TIGHTEN ALL FASTENERS

6. REPEAT PROCEDURE ON PASSENGER SIDE (PS)

DIAGRAM (DRIVER SIDE)

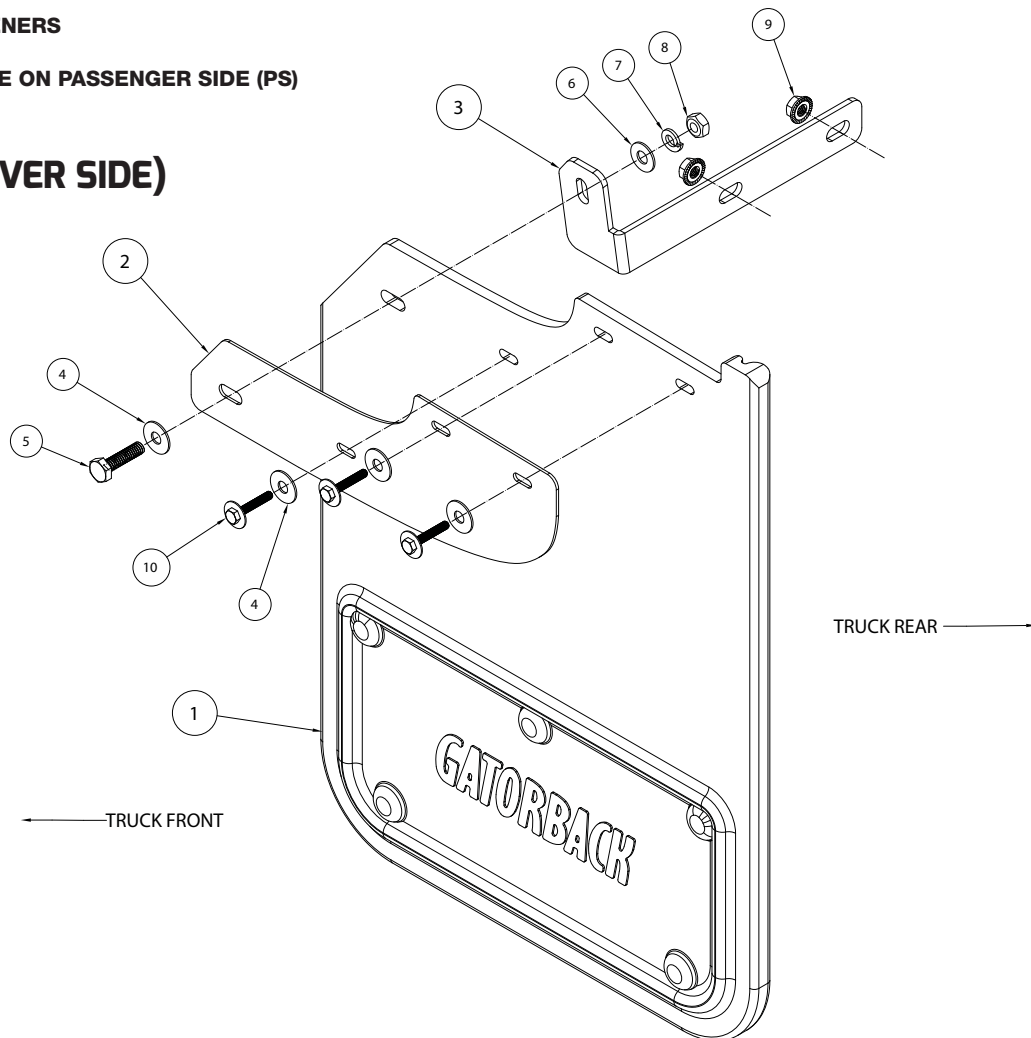

NOTICE

These instructions and enclosed parts have been provided in response to the Ford 2015 F150 SVE Bulletin. Any deviation of the installation and/or hardware may result in premature corrosion. The Manufacturer and/or Dealer Distributor are not responsible for negligent use or installation.