

IMPORTANT:

Manufacturer is not responsible for negligent use of vehicle with mud flaps installed, including over-tightening of screws and bolts causing damage to vehicle or mud flaps.

NO-DRILL SYSTEM

TOOLS REQUIRED-

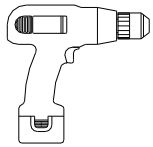

Electric or Rechargeable Drill



1/4" Drill Bit



Push Pin Removal Tool

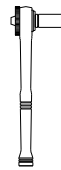

OR

3/8" Open Wrench or Socket Wrench

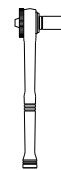

OR

5/16" Open Wrench or Socket Wrench

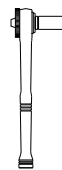

OR

7/16" Open Wrench or Socket Wrench

FLAPS

(1) Flap Front, DS

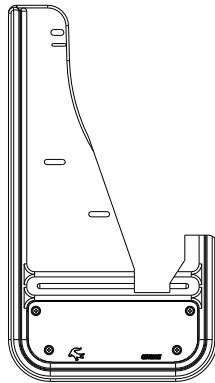

(1) Flap Front, PS

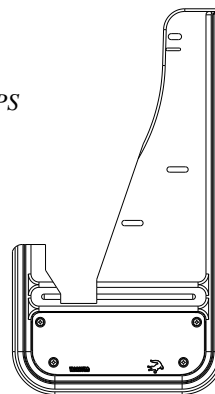

PARTS BAG # 766740

a) (2) Screw, Machine
 SS, #18-8, 10-24 x 1" Hex
 Part #012022



b) (4) Screw, Sheet Metal
 SS, Blk, M4.2 x 1"
 Part #016041

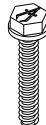

c) (2) Capscw, SS
 1/4" - 20x1"
 Part #014007

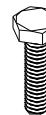

d) (4) Spring Nut
 #28, 9/16" Reach
 Part # 028004



e) (2) Washer, Lock
 18-8SS, 10 Helicoil
 Part #024001



f) (2) Nut, Hex
 SS, #10-24
 Part # 025003



g) (1) Mount Clip
 Driver's Side
 Part #750582

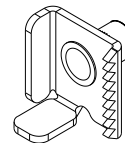

h) (1) Mount Clip
 Passenger's Side
 Part #750584

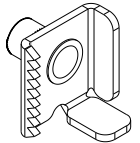

i) (4) Washer, Flat
 0.203" x 1", SS
 Part #018031

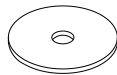

j) (2) Washer, Flat
 0.281" ID x 1" OD, 18ga, SS
 Part #018028

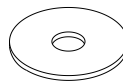

k) (4) Washer, Flat
 0.203" x 1.5", 18ga, SS
 Part #018066

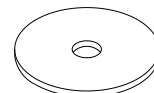

INSTALLATION *(For ease of installation it is suggested that the wheel be removed)*

1. Before you install your Mud Flap Set, see the diagram and parts list for all necessary parts.
2. Remove the (2) factory nylon push pins on the inside of the fender and discard them.
3. Remove the (1) factory push pin on the underside of the fender and set aside to reinstall later.
3. Pull back the wheel well molding and inner liner to reveal the factory holes that contained the factory push pins.
4. Install the (2) spring nuts onto each of the (2) factory holes #5 & #6. (See Diagram #2)
5. Move plastic guard back into place and reinstall the factory push pin on the underside of the fender.
6. Loosely install the mud flap starting with hole #3, then #2 the inner fender through holes #6 & #5 using (2) sheet metal screws (016041) and (2) 1-1/2" flat washers (018066).
7. Install the mount clip on the back of the mud flap through slotted hole #1 and secure using a capscrew (014007) and flat washer (018028).
8. Install clip behind the fender lip and loosely secure all fasteners.
8. Using a bubble level or square, ensure that the mud flap is level. Viewing the vehicle from the back, the outer edge of the mud flap should appear parallel to the tires.
9. Carefully tighten all screws and double-check that the flap has remained level.
10. With a 1/4" drill bit, drill a hole through mud flap creating hole #4 and through the plastic liner creating hole #7.
11. Install the mud flap through hole #4 to the liner hole #7 using a machine screw (012022), two flat washers (018031), one lock washer (024001), and one hex nut (025003).
12. Repeat procedure for the passenger side.

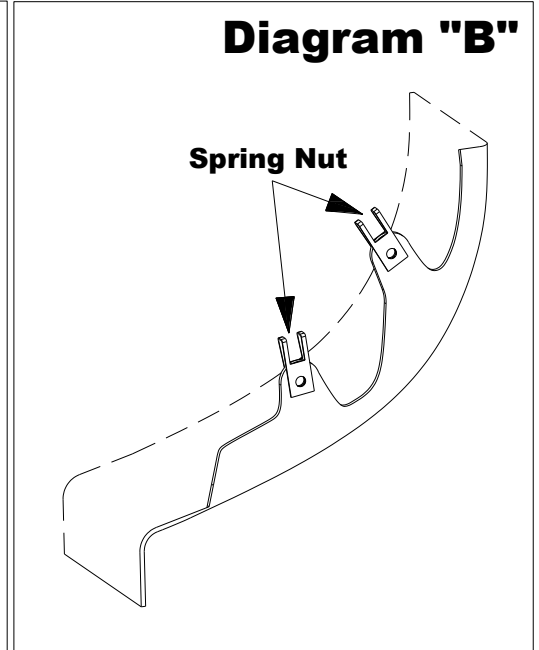
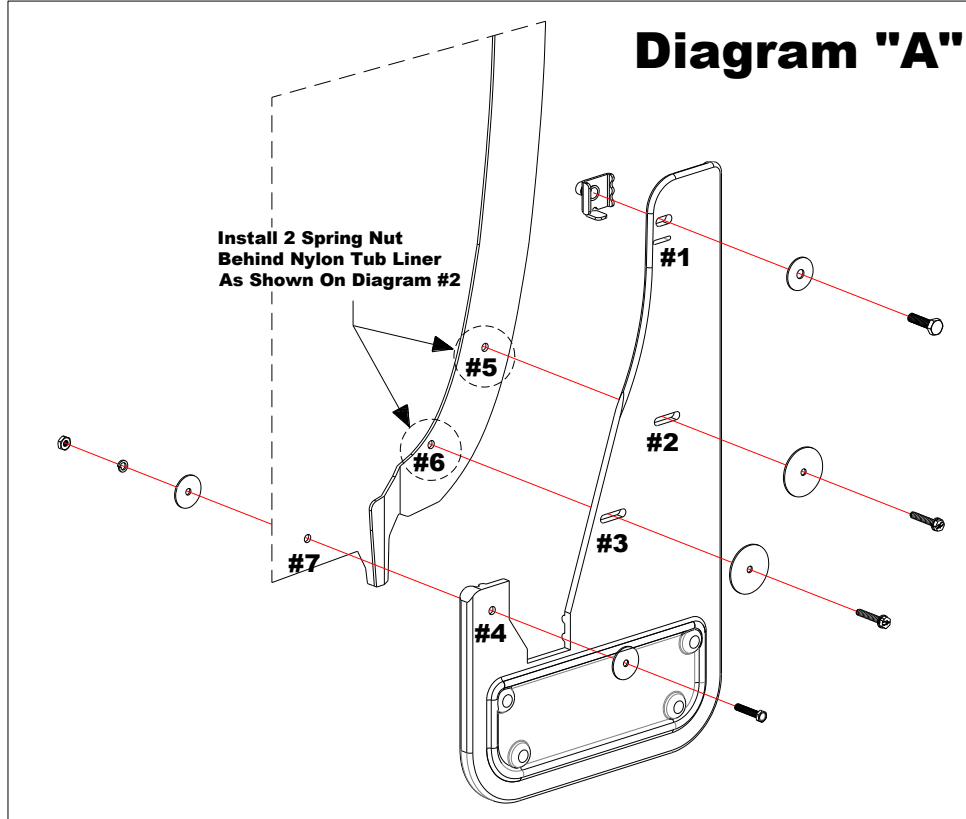

Please check out our YouTube channel to see an install video for this application.



IMPORTANT:

Manufacturer is not responsible for negligent use of vehicle with mud flaps installed, including over-tightening of screws and bolts causing damage to vehicle or mud flaps.

NO-DRILL SYSTEM

TOOLS REQUIRED-

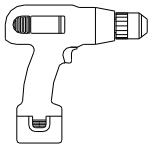

Electric or Rechargeable Drill



1/4" Drill Bit



Push Pin Removal Tool



OR



5/16" Open Wrench or Socket Wrench



OR



3/8" Open Wrench or Socket Wrench

FLAPS

(1)Flap Front, DS

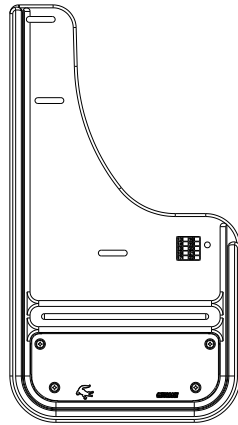

(1)Flap Front, PS

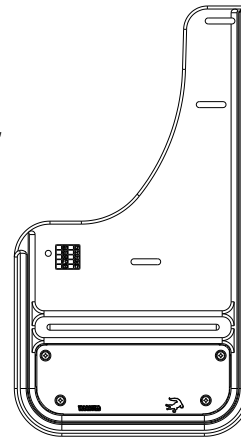

PARTS BAG # 766746

*a) (6) Washer, Flat
 0.203" x 1.5", 18GA, SS
 Part #018066*

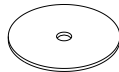

*b) (4) Washer, Flat
 0.203"ID x 1"OD, 18ga, SS
 Part #018031*



*c) (2) Washer, Lock
 18-8SS, Helicoil
 Part #024001*



*d) (2) Screw, Mach.
 18-8SS, 10-24x1, Hex Hd
 Part # 012022*



*e) (2) Nut, Hex
 #10-24, SS
 Part # 025003*



*f) (6) Bolt, Hex Flange, SS
 M 4.2 x 1", Black
 Part #016041*

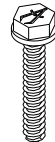

INSTALLATION *(For ease of installation it is suggested that the wheel be removed)*

1. Before you install your Mud Flap Set, see the diagram and parts list for all necessary parts. Start on the driver's side.
2. Remove the 3 factory screws from the inner wheel well.
3. Install the mud flap to the fender through holes #1 to #3 into holes #5 to #7 using a sheet metal screw (#016041) and a stainless steel washer (#018066). Loosely secure at this point.
4. Using a bubble level or square, ensure that the mud flap is level. Viewing the vehicle from the back, the outer edge of the mud flap should appear parallel to the tires.
5. Drill a 1/4" hole through the mud flap to create hole #4 and through the liner to create hole #8.
6. Secure the mud flap through hole #4 to the liner through hole #8 using a machine screw (#012022), two stainless steel washers (#018031), a lock washer (#024001) and a hex nut (#025003).
7. Carefully tighten all fasteners and ensure that the mud flap has remained level.
8. Repeat procedure for the passenger side.

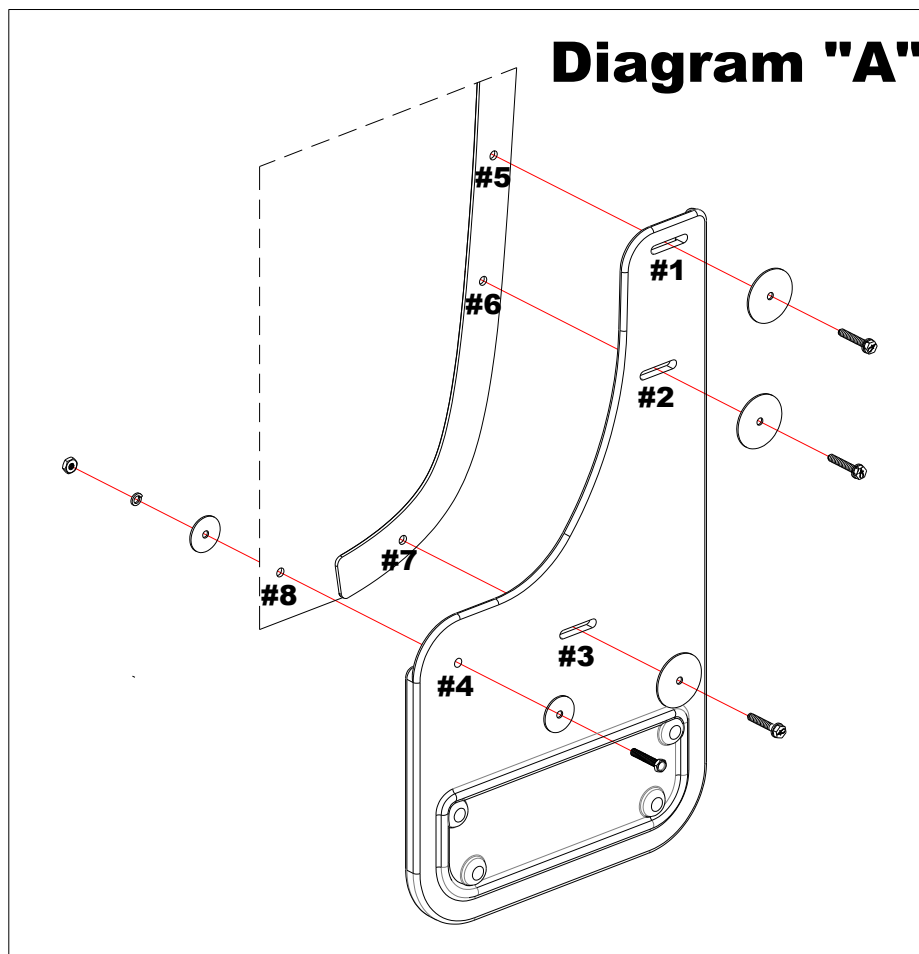

Please check out our YouTube channel to see an install video for this application.

