



GATORBACK MUDFLAPS

2015-2020 Nissan Murano Mud Flap Set, Front Mounting Diagram & Instructions Kit# GCR54F

IMPORTANT:

Manufacturer is not responsible for negligent use of vehicle with mud flaps installed, including over-tightening of screws and bolts causing damage to vehicle or mud flaps.



TOOLS REQUIRED-

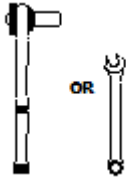

5/16" Open Wrench or
Socket Wrench

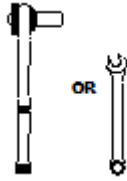

3/8" Open Wrench or
Socket Wrench

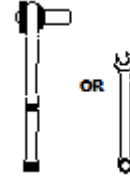

7/16" Open Wrench or
Socket Wrench



1/4" Drill
Bit

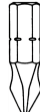

Phillips Head
Bit

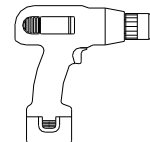

Electric or Rechargeable
Drill

FLAPS

(1) Flap Assembly,
Front, DS

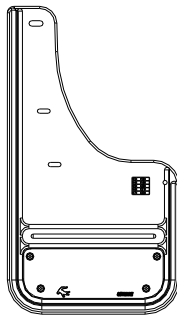

(1) Flap Assembly
Front, PS

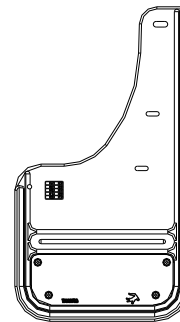

PARTS BAG # 768469

a) (4) Washer, Flat
0.203" x 1.5", Blk Oxid.
Part #018072

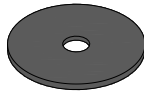

b) (2) Washer, Flat
0.281" x 1", Blk Oxid.
Part #018069



c) (4) Washer, Flat
0.203" x 1" Blk Oxid.
Part #018070



d) (2) Screw, Machine
10-24x1-1/2", Hex Hd
Part #012027

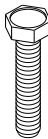

e) (4) Screw, Sheet Metal
#10-12 x 1-1/4" Phillips Head, SS
Part # 010027

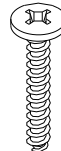

f) (2) Capscrew
1/4"-20 x 1", Blk Oxid.
Part # 014069



g) (2) Washer, Lock
18-8SS, Helicoil
Part #024001



h) (2) Nut, Hex
#10-24, SS
Part #025003



i) (2) Spring Nut
1/4"-20UNC Ext.27/32" Reach
Part #028006



INSTALLATION *(For ease of installation it is suggested that the wheel be removed)*

1. Before you install your Mud Flap Set, see the diagram and parts list for all necessary parts. Start on the driver's side.
2. Remove the factory screws from the inner wheel well, and the underside of the fender in order to remove the factory splash guard. Reinstall the factory screw on the underside of the fender.
3. Remove factory push pin from underside of the fender. Set aside to be reinstalled later.
4. Loosely install the mud flap through hole #2 & #3 into the existing factory holes #5 & #6 using a stainless steel screw (#010027), and a 1.5" black stainless steel washer (#018072).
5. Using a bubble level or square, ensure that the mud flap is level. Viewing the vehicle from the back, the outer edge of the mud flap should appear parallel to the tires.
6. Mark the fender through mud flap hole #1 as a guide. Install spring nut (#028006) on fender well over the mark.
7. Install mud flap hole #1 to spring nut (#028006) using a cap screw (#014069) and flat washer (#018069)
8. Hold the mud flap firmly to the liner and drill a 1/4" hole through the mud flap hole #4 to create hole #7 in the liner. Install the mud flap hole #4 to the liner hole #7 using a machine screw (#012027) and flat washer (#018070).
9. Fold back the bottom portion of the liner in order to gain access to the back of the machine screw (#012027) and secure it with a flat washer (#018070), a lock washer (#024001) and a hex nut (#025003).
10. Reinstall factory push pin on underside of the fender.
11. Repeat procedure for the passenger side.

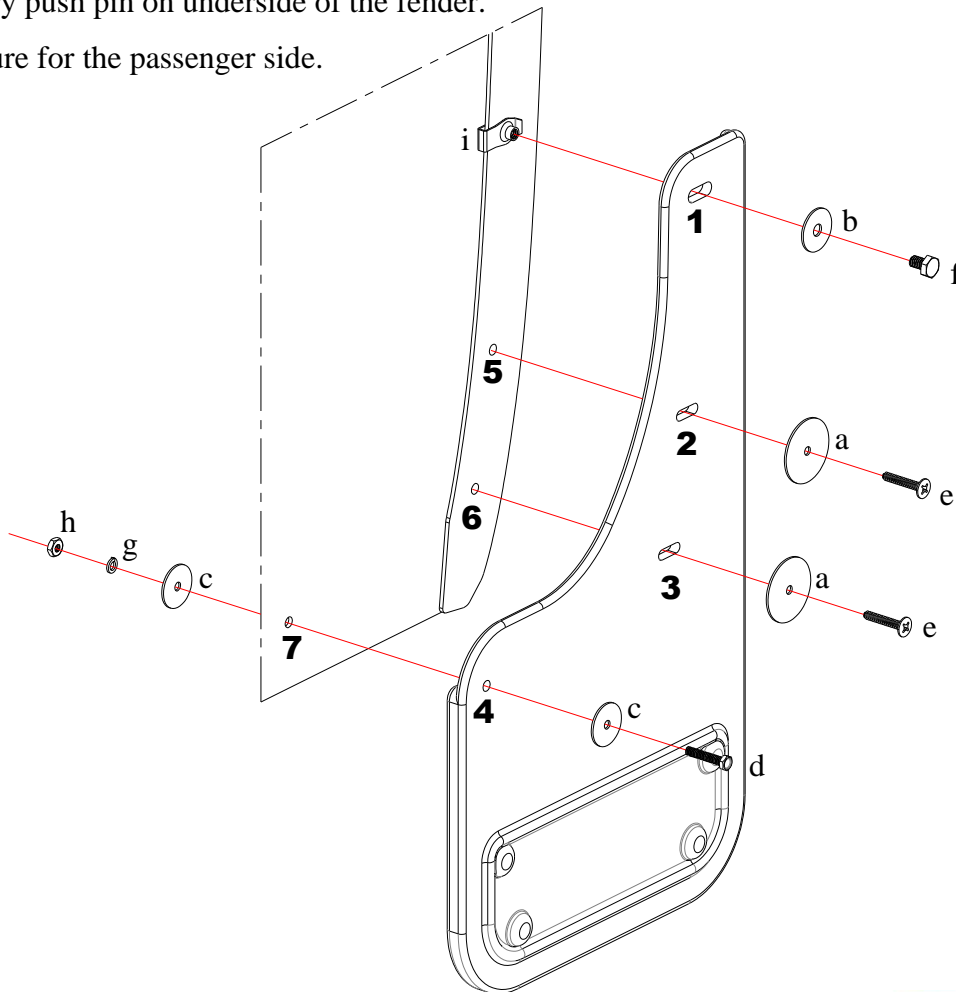

Please check out our YouTube channel to see an install video for this application.





GATORBACK MUDFLAPS

2015-2020 Nissan Murano Mud Flap Set, Rear Mounting Diagram & Instructions Kit# GCR54R

IMPORTANT:

Manufacturer is not responsible for negligent use of vehicle with mud flaps installed, including over-tightening of screws and bolts causing damage to vehicle or mud flaps.



TOOLS REQUIRED-

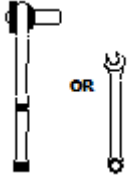

5/16" Open Wrench or
Socket Wrench

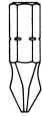

Phillips Head
Bit

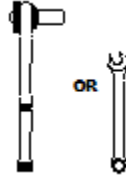

3/8" Open Wrench or
Socket Wrench

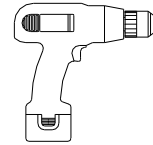

Electric or Rechargeable
Drill



1/4" Drill
Bit

FLAPS

(1) Flap Assembly,
Rear, DS

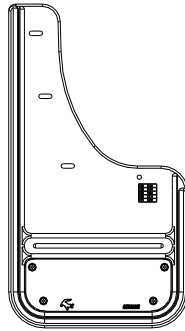

(1) Flap Assembly
Rear, PS

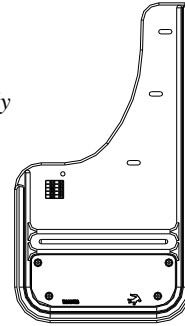

PARTS BAG # 768470

a) (6) Washer, Flat
0.203" x 1.5", Blk Oxid.
Part #018072

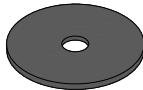

b) (4) Washer, Flat
0.203" x 1", Blk Oxid.
Part #018070

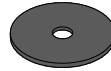

c) (6) Screw, SM
#10-12 x 1-1/4", SS
Part # 010027

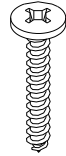

d) (2) Screw, Machine
18-8SS, 10-24x1, Hex Hd
Part #012022

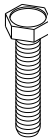

e) (2) Nut, Hex
#10-24, SS
Part # 025003



f) (2) Washer, Lock
18-8, Helicoil, SS
Part #024001



INSTALLATION (For ease of installation it is suggested that the wheel be removed)

1. Before you install your Mud Flap Set, see the diagram and parts list for all necessary parts. Start on driver's side.
2. Remove the factory screws from the inner wheel well, and the underside of the fender in order to remove the factory splash guard. Reinstall the factory screw on the underside of the fender.
3. Loosely install the mud flap through holes #1 to #3 into the existing factory holes #5 to #7 using a stainless steel screw (#010027), and a 1.5" black stainless steel washer (#018072).
4. Using a bubble level or square, ensure that the mud flap is level. Viewing the vehicle from the back, the outer edge of the mud flap should appear parallel to the tires. Tighten all fasteners.



5. Hold the mud flap firmly to the liner and drill a ¼" hole through the mud flap hole #4 create hole #8 in the liner. Install the mud flap hole #4 to the liner hole #8 using a machine screw (#012022) and flat washer (#018070) and secure it with a flat washer (#018070), a lock washer (#024001) and a hex nut (#025003).
6. Repeat procedure for the passenger's side.

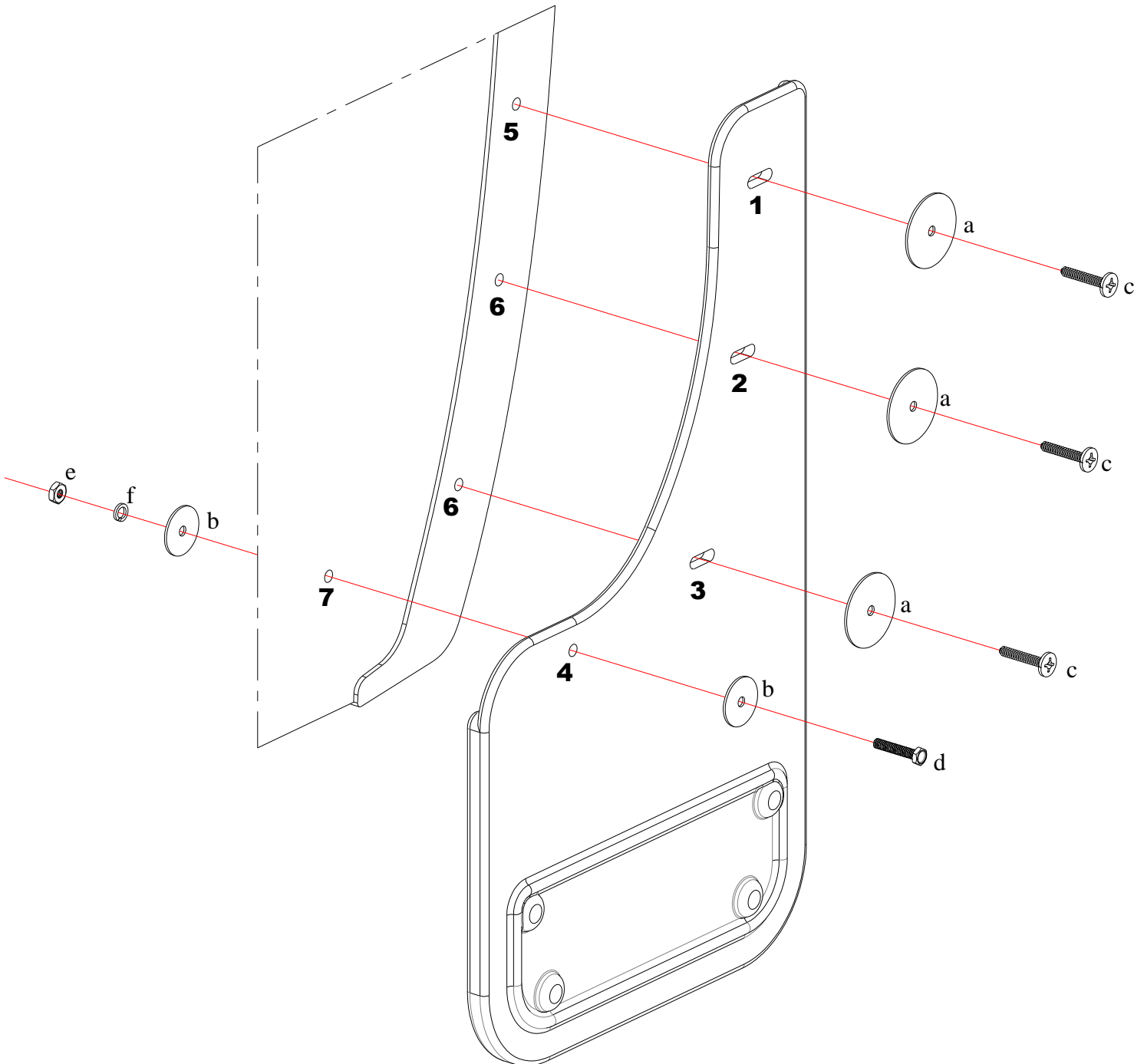

Please check out our YouTube channel to see an install video for this application.

